



www.superiorparts.us



SKIL PARTS

O-RINGS & GASKETS

CARBON BRUSHES



DRIVERS

MAGAZINE ASSEMBLIES

NAIL FEEDERS

BUMPERS

FLUSH NAILERS



PRODUCT CATALOG VOL. 1023

Description	Page #
Metabo HPT Aftermarket Parts & Accessories	
Piston Driver Assemblies	6 - 14
Piston Bumpers	15 - 18
Steel Magazine Assemblies & Parts	19
Aluminum Magazine Assemblies & Parts	20 - 21
O-Rings & Kits	22 - 28
Gaskets & Sets	29 - 31
Nuts / Bolts / Washers	32
Nailer Body & Parts	33 - 46
Trigger & Plunger Valve Assemblies	47 - 48
Metabo HPT NR83 Series Parts	
Piston Drivers & Bumpers	49
O-Rings & Kits	50 - 51
Gaskets & Sets	52
Nuts / Bolts / Washers	53
Pins / Shafts / Springs	54 - 55
Magazine Feed & Other Parts	56 - 63
Service Kits	64 - 68
Metabo HPT NV83 Series Parts	
Piston Drivers & Bumpers	69
O-Rings & Gaskets	70
Nuts / Bolts / Washers	71
Springs / Pins / Shafts	72
Magazine Feed & Other Parts	73 - 75
Service Kits	76 - 77
Metabo HPT NV45 Series Parts	
Piston Drivers & Bumpers	78
O-Rings & Kits	79
Gaskets & Sets	79
Nuts / Bolts / Washers	80
Springs / Pins / Shafts	80 - 82
Magazine Feed & Other Parts	82 - 85
Service Kits	86
Metabo HPT N5008AC Parts	
Piston Drivers & Bumpers	87
O-Rings & Gaskets	87
Nuts / Bolts / Springs	88
Other Parts	89
Metabo HPT N5010A Parts	
Piston Drivers	90
O-Rings & Gaskets	90
Nuts / Bolts / Springs	91
Other Parts	92

Description	Page #
Metabo HPT NR65AK2 Parts	
Piston Driver & Bumpers	93
Gaskets & O-Rings	93
Nuts / Bolts / Springs	94
Other Parts	94
Metabo HPT NR90AE Parts	
Piston Driver & Bumper	95
Other Parts	95
Metabo HPT NT50A / AE Parts	
Piston Driver & Bumper	96
Gaskets & O-Rings	96
Nuts / Bolts / Springs	97
Other Parts	98
Metabo HPT NT65M2 Parts	
Piston Driver & Bumper	99
O-Rings	99
Nuts / Bolts	99
Other Parts & Service Kits	100
Metabo HPT NT65MA2 Parts	
Piston Driver & Bumper	101
Gasket & O-Rings	101
Nuts / Bolts / Other Parts	102
Metabo HPT NV50AA Parts	
Gasket & O-Rings	103
Nuts / Bolts / Springs	103 - 104
Other Parts	105
Metabo HPT NV65AH Parts	
Piston Driver & Bumper	106
Gasket & O-Rings	106
Service Kits	107
Springs / Nuts / Bolts	107 - 108
Metabo HPT NV75AN Parts	
Piston Driver & Bumper	109
Gasket & O-Rings	109
Original Metabo HPT Parts	110 - 114
Max Parts	115 - 124
Max CN55 Parts	125 - 129
Max CN70 Parts	130 - 135
Max CN80 Parts	136 - 140

Description	Page #
Senco Parts	141
Paslode Parts	142
Paslode F250S Parts	143
Paslode F350S Parts	144 - 145
Bostitch Parts	146
Bostitch RN46 Parts	147 - 148
Porter Cable Parts	149
Dewalt DW66 Parts	150
Makita AN611 Parts	151
Nailer / Stapler Hooks & Accessories	152 - 155
Replacement Electrical Cords	156 - 160
Electrical Extension Cords	161
Electrical Boots / Cord Protectors	162 - 163
Metal Power Strip / Storage Strap	164
Connectors / Terminal / Wire Stripper	165 - 167
Plastic Compartment Boxes	168
Power Tool Replacement Electrical Switches	169 - 178
Magentic Switches	179
Compressor Overload Switches	180
Foot Pedal Electrical Switch	180
Electric Motor Capacitors	181
Compressor Pressure Switches	182
Carbon Brushes	183 - 192
Bearings	193 - 196
Water Pumps / Motor Oil / Diesel Extractor	197
Router Collets / Router Template / Router Trap Adapter	198
Planer Parts	199
Drill Chucks & Holders (Keyed/Keyless)	200 - 206
Skil Saw Parts	207 - 209
Grinder Adapters / Collets / Wrenches	210 - 211
Airless Paint Spray Gun Parts	212
Compressor Check Valves	213
Compressor Valves (Drain, Pressure Relief)	214 - 215
Pilot Valves (Made In USA)	216 - 217
Pressure Gauges	218 - 219
Compressor Intake Filters	220
Compressor Parts	221
Manifolds	222 - 223
Tool Bags & Repair Tags	224
Oil Air Tool & Compressors	225 - 226
Rags & Towels	227

**100% GUARANTEED UNI-LOK® DESIGN
MECHANICALLY LOCKED SHAFT ON ALUMINUM PISTON**

SUPERIOR PARTS “THREE-STEP-PROCESS” TO LOCK



After applying Glue to threads, the Aluminum piston is hydraulically crimped into the grooves of the steel shaft using a fully computer controlled 10 ton press.



**Higher Strength Driver Blade
uses Japanese Carbide SKH-9
in lieu of Standard Alloy Steel**

UNI-LOK®

Mechanically locked shaft is 100% tougher and better than Loctite glue alone.

PREMIUM GRADE ALUMINUM

Our driver uses aerospace grade Aluminum 2024.

TORQUE TESTING

Drivers do not unscrew even at 80 N-M (59ft.-lbs) during Torque Testing. The steel will twist almost 40° but the shaft will not unscrew.



HEAT TREATMENT

Drivers are heat treated in computer controlled, well insulated oven to get very stable heat treatment along the length of the driver shaft in all areas of the furnace.

Superior Parts uses this advanced method to ensure consistent product.

Driver is annealed at the threaded end to lower the hardness and make the material more ductile to take the impact shock without fracturing.

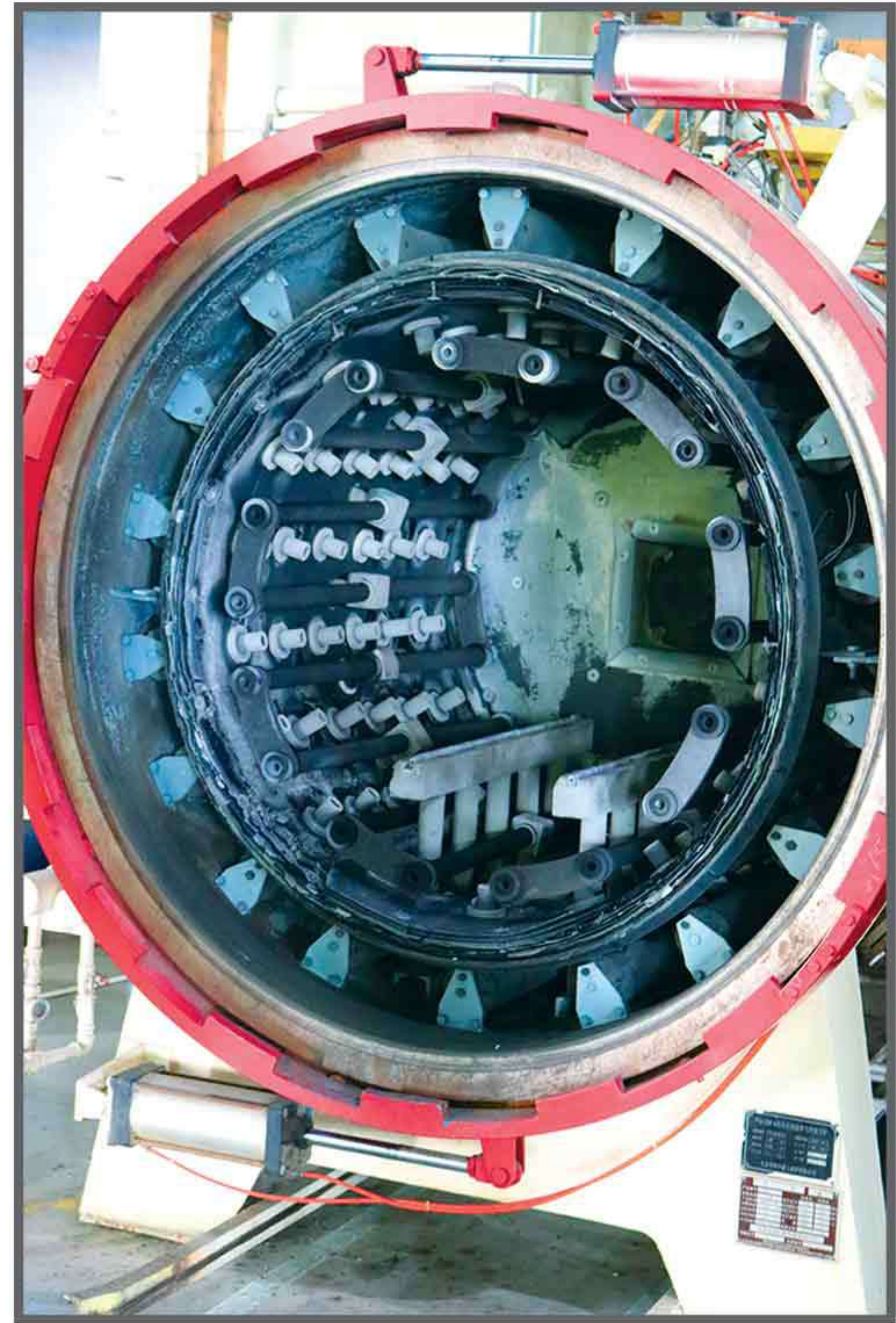

ROCKWELL HARDNESS TESTING (HRC)



Standard Alloy Drive Hardness Ranges between 56-59 HRC along the shaft
Japanese Carbide Hardness is 65 HRC

Superior Parts® Aftermarket Replacement drivers are made using Japanese Carbide SKH-9 and Chinese Alloy Steel materials. Japanese Carbide is excellent for hardness and wear resistance with a HRC of 65, whereas alloy steel has a hardness of HRC of 56 - 59. Both drivers are annealed at the threaded end to lower the hardness and make the material more ductile to take the impact shock without fracturing.

All Superior Parts® drivers are crimped at the Aluminum base and can withstand a torque of 80 N-M (59 ft-lb) before the Aluminum shears off. However, drivers that don't have enough Aluminum material at the base are only threaded, glued and torque tested to 30 N-M (22 ft-lb).

METABO / HITACHI

	Part #	Nailer / Stapler Model #
	SP 877-323*	NR83A + A2 + A3 + A2(S) + A3(S) / NV75A
	SP 877-323C*	NR83A + A2 + A3 + A2(S) + A3(S) / NV75A (Japanese Carbide Driver)
	SP 877-323U*	NR83A + A2 + A3 + A2(S) + A3(S) / NV75A (USA S7 Steel Driver)
	885-915	NR83A + NR83A2 + A3 + A2(S) + A3(S) / NV75A (Made in Japan) - Original Metabo HPT Driver
	SP 885-915*	NR83A + A2 + A3 + A2(S) + A3(S) / NV75A (Replaces 877-323)
	SP 878-156	NV45AB + AB2 + AB2(S)
	SP 878-428*	NV83 + A2 + A3 + A14
	SP 878-428C*	NV83 + A2 + A3 + A14 (Japanese Carbide Driver)
	SP 885-918*	NR90AE + AE(S) (Replaces 885-519 & 887-491)
	SP 876-734	VH650 / NV65
	SP 878-309C*	NV65AC (Japanese Carbide Driver)
	SP 878-630	NR83AA (Replaces 878-301)







* Driver with UNI-LOK®

METABO / HITACHI

	Part #	Nailer / Stapler Model #
	SP 882-684*	NV65AH (Replaces 880-650)
	SP 882-340	NT50AE + AE(S) (Replaces 882-283)
	SP 882-402*	NT65A2 & A3 w/o O-Ring
	SP 883-471	NR65AK + AK(S) + AK2
	SP 883-471C	NR65AK + AK(S) + AK2 (Japanese Carbide Driver)
	SP 884-330	NT65MA2 + MA3 + MA4 + MA4(S)
	SP 883-510*	NR83AA2 + NR83AA3 + NR83AA4
	SP 883-716	N5008AC + AC2
	SP 883-980C*	NV75AG / NV85AG (Japanese Carbide Driver)
	SP 885-917*	NR90AD + ADPR (Replaces SP 884-957)
	SP 888-033*	NV90AG
	SP 884-643	NP35A
	SP 885-667	NT65M2
	SP 885-870	NT50A5 + NT50A5M + NT50AE2 + AE2(S)
	SP 888-160*	NV83A4

* Driver with UNI-LOK®

METABO / HITACHI

	Part #	Nailer / Stapler Model #
	SP 888-160C*	NV83A4 (Japanese Carbide Driver)
	SP 888-423	NV75AN
	SP 886-437	N5010A
	SP 888-588	NR38AK
	SP 877-898	NV50A1
	SP 886-448	N5021A
	SP 884-357	N5024A / A2 / A2M



	Part #	Nailer / Stapler Model #
	SP 150744-3	AN611
	SP 347519-1	DFN350 & DFN350Z-Type-2
	SP HY00000018	AF505 / AF505N
	SP 345702-4	BPT350 / BPT350Z / LXTP01 / LXTP01Z / TP03Z / XTP01Z / XTP02Z

* Driver with UNI-LOK®



	Part #	Nailer / Stapler Model #
	SP 163816*	N89C, N89C-1P-Type-0, N89C-HQ-Type-0
	SP 174061C*	MCN150 (Japanese Carbide Blade)
	SP 175560C*	MCN250 & MCN250S (Japanese Carbide Blade)
	SP N100117A*	N100C
	SP N80157A*	N80C & N80CB (Japanese Carbide Blade)
	SP 102630*	N70CBM & N70CBPAL (Replaces 102869)
	SP 107510	N62FN & N62FNK-2 w/o O-Ring
	SP 11204-1010001	N64084-N64099 (Replaces 5140093-40)
	SP 101961*	RN45B & WM45B
	SP 149826*	RN46 & RN46-1
	SP 180451	BT1855 & BTFP 12233 (Type-1)
	SP 120075	BT200
	SP 180205	SX1838 & EHF1838K w/o O-Ring Porter Cable NS150C, Dewalt DWFP12232
	SP G0209200U	N66C /N66C-1 w/o O-Ring Dewalt DW66C-1 - US S7 Material

* Driver with UNI-LOK®



	Part #	Nailer / Stapler Model #
	SP 9R213392	IC60



	Part #	Nailer / Stapler Model #
	SP CN81200C*	CN55 (Japanese Carbide Blade)
	SP CN81204C*	CN70 (Japanese Carbide Blade)
	SP CN81206C*	CN80 & CN80F (Japanese Carbide Blade)
	SP KN70136	SN883CH-28 / CH2-28
	SP KN70164C*	SN883RH2 + RH (Replaces KN70091) (Japanese Carbide Blade) w/o O-Ring
	SP TA81078	NF235A-23-25 (USA S7 Steel)
	SP CN35262U	CN565S (USA S7 Steel)
	SP CN81266	CN565S2



	Part #	Nailer / Stapler Model #
	SP EA0113	SNS45XP
	SP EA0138	Finish Pro 41XP





* Driver with UNI-LOK®



	Part #	Nailer / Stapler Model #
	SP EA0138-2	Finish Pro 41XP w/o O-Ring (with 2 grooves)
	SP EA0156	Finish Pro 32 & 32MG
	SP EA0163*	Frame Pro 652 & 602
	SP EA0164*	Frame Pro 651 & 601
	SP EA0167	Finish Pro 35
	SP EA0177	Finish Pro 10
	SP EA0150	SFN1
	SP EA0180	Finish Pro 15
	SP EA0233	Joist Pro 250XP
	SP EA0181	Finish Pro 18
	SP EC0344	Finish Pro 25XP
	SP EA0351	Finish Pro 21LXP
	SP EA0352	Finish Pro 23LXP
	SP EA0353	Finish Pro 23SXP
	SP EA0285	JoistPro 150XP

* Driver with UNI-LOK®



	Part #	Nailer / Stapler Model #
	SP 501468*	F250S
	SP 502308C*	PF150S-PP (Japanese Carbide Driver)
	SP 501519	F350S - Positive Placement
	SP 403202U	501230-(S200-S16) (US S7 Steel)
	SP 511013U	PF237C (US S7 Material)
	SP 500729	500729 Driver Blade Seal



	Part #	Nailer / Stapler Model #
	SP 501468	DF 250-MC
	SP 502976U	DF225C (US S7 Material)



	Part #	Nailer / Stapler Model #
	SP 202604001DB	P320

* Driver with UNI-LOK®

Superior Parts® Aftermarket Replacement Bumpers are made using virgin polyurethane material from Germany, Taiwan & China. These are injection molded using numerical controlled molding machines

METABO / HITACHI

	Part #	Nailer / Stapler Model #
	SP 878-303	NR83A/NR83A2 (Standard Ivory Color) - PU Material
	SP 878-303G	NR83A/NR83A2/NV83A/NV65AC/NV75A (Premium Green Color) - PU Material
	SP 878-303RED	NR83A, NR83A2, NR83A2(S) - 883-511, 878649, 877376 (German Material Red)
	SP 878-649	NR83AA Short (B) - PU Material
	SP 884-959	NR90AE/AE(S)/AD/ADPR/AF & NV90AG Replaces 888-100 - PU Material
	SP 882-287	NT50AE, NT50AES, N3804AB2 - Rubber Material
	SP 885-669	NT65M2 - Rubber Material
	SP 877-993	NV45AB2/AB2(S)/AB/AA - PU Material
	SP 877-993UN	NV45AB2/AB2(S)/AB/AA - PU Material
	SP 877-711	NV83A, NV83A2, NV83A3, NV65AC, NV50AG, NV85AG & NV90AG
	SP 878-179	NV45AB2/AB2(S)/AE/AB NT50A /VH501/N5008A1 - PU Material
	SP 883-711	N5008AC

METABO / HITACHI

	Part #	Nailer / Stapler Model #
	SP 883-432	NR65AK, NV75AG, NR65AK2, NR65AK(S)
	SP 888-429	NV75AN
	SP 888-594	NR38AK
	SP 882-676	NV65AH
	SP 884-350	N5021A & N5024A Replaces 884-350
	SP 887-170	NT65MA4(S), NT65MA4M
	SP 881-741	NT65AA, NT65MA, NT65MA2, NT65MA3, NT65MA4
	SP 881-761	NT65AA, NT65MA, NV65AH / AH2 / AH2M
	SP 886-434	N5008AC2, N5008AC2M, N5010A, N5010AM, NT65A5, NT65A5M
	SP 881-756	Bumper Sheet for NT65MA2, NT65MA3, NT65AA, NT65MA, NT65MA4(S)
	SP 883-712	Bumper Sheet for N5008AC





BUMPERS



	Part #	Nailer / Stapler Model #
	SP MB55 Paslode 405366 Max CN31890	CN55 Coil Nailer
	SP MB70 (OE # CN31563 & CN31564)	CN70 Coil Nailer - 2 PC Set
	SP CN31890	CN55 (CN55A2-26)
	SP CN34714	CN445R, CB450R



BUMPERS





	Part #	Nailer / Stapler Model #
	SP 191777	RN46, RN64-1, SF150C
	SP 174075	MCN150, N66C, N66BC, N66BC-1 (Type 0), N66C-1 (72400000)
	SP 175562	MCN250, N75C
	SP 174054	Head Valve for MCN150, MCN250, N66, CF15, N75, DeWALT DW66, DWMC150



BUMPERS

	Part #	Nailer / Stapler Model #
	SP N70156 (OE # N70156)	N80SBM, N80SB, N80CBMLPAL, N80CB-1ML, N80CB, SDN11RH, SDN11PTB, N79WW, N79RH, N79PT, N95RHN, N90PT, N70CBPAL, N70CBM, N80S Type 0, N80C Type 0, RN90PLEX (Type 0), N80CB-1 (Type 0), N80CB-HQ (Type 0), N71C (Type 0), N80CB (Type 0), SDN11PTB (Type 0), N80SB (Type 0), N79PT (Type 0), N80CB-1ML (Type 0), N79WW (Type 0), N79RH (Type 0), N80SBM (Type 0), N95RHN (Type 0), N70CBM (Type 0), SDN11RH (Type 0), N90PT (Type 0), N80CBMLPAL (Type 0)
	SP N70157 (OE # N70157)	N80SBM, N80SB, N80CBMLPAL, N80CB-1ML, N80CB, SDN11RH, SDN11PTB, N79WW, N79RH, N79PT, N95RHN, N90PT, N70CBPAL, N70CBM, N80S Type 0, N80C Type 0, RN90PLEX (Type 0), N80CB-1 (Type 0), N80CB-HQ (Type 0), N71C (Type 0), N80CB (Type 0), SDN11PTB (Type 0), N80SB (Type 0), N79PT (Type 0), N80CB-1ML (Type 0), N79WW (Type 0), N79RH (Type 0), N80SBM (Type 0), N95RHN (Type 0), N70CBM (Type 0), SDN11RH (Type 0), N90PT (Type 0), N80CBMLPAL (Type 0)



	Part #	Nailer / Stapler Model #
	SP 500866	PF350S, F350S, F400S, F325C, F250S-PP
	SP 502317	PF150S-PP
	SP 404419	900420 (IMCT), 902200 (CF325), 902600



	Part #	Description	Nailer / Stapler Model #
	SP 250XPB	Bumper	JoistPro250XP

METABO HPT NR83A/A2/A3 STEEL MAGAZINE ASSEMBLIES

SP 884-065 Bare Magazine



Part # Nailer / Stapler Model #

SP 884-065 NR83 + A2 + A2S

SP 884-570 NR83A (2 Hole Bracket)

SP 885-827 NR83A + A2 + A2S
(1 Hole Bracket)



SP 885-827
One (1)
Hole Assembly



SP 884-570
Two (2)
Hole Assembly

Shoots up to 3-1/4" Long Nails

STEEL MAGAZINE ASSEMBLY PARTS LIST



No.	Part #	Description
11	SP 885-827A-11	Roller Pin
36	SP 963-837	Nylon Nut (M6)
37	SP 884-066	Handle Arm (1 Hole)
37	SP 884-571	Handle Arm (2 Hole)
53	SP 949-657	Hex Socket HD. Bolt (M6x12)
75	SP 877-393Z	Nail Feeder
76 / 77	SP 878-421	Ribbon Spring + Pin (set)
78	SP 876-465	Nylon Nut (M4)
79	SP 949-453	Spring Washer (M4)
80	SP 877-371	Nut (M5)
81	SP 949-454	Spring Washer (M5)
82	SP 884-065	Bare Magazine
83	SP 876-550	Sleeve
84	SP 949-824	Hex Head Bolt (M5x45)
85	SP 949-650	Hex Head Bolt (M4x15)
87	SP 877-396Z	Stop Lever
88	SP 877-398	Collar
89	SP 877-397	Stopper Spring
90	SP 885-827AB	Aluminum Magazine Assembly (Black)



METABO HPT NR83A/A2/A3 ALUMINUM MAGAZINE ASSEMBLIES

SP 885-827A



Part #	Nailer / Stapler Model #
SP 885-827A	NR83 + A2 + A2S

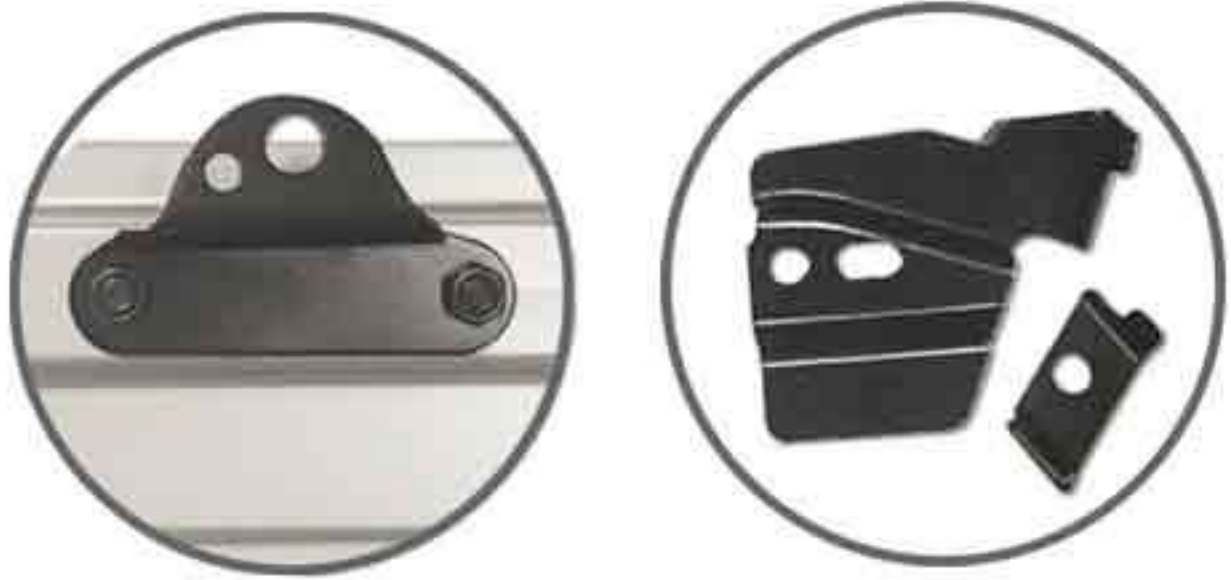

Comes with Ribbon Spring + Nail Feeder Pre-Installed
Shoots up to 3-1/2" Long Nails
Dual ROLE Bracket Handle-Arm for One & Two Hole Nailer Models

ALUMINUM MAGAZINE ASSEMBLY PARTS LIST

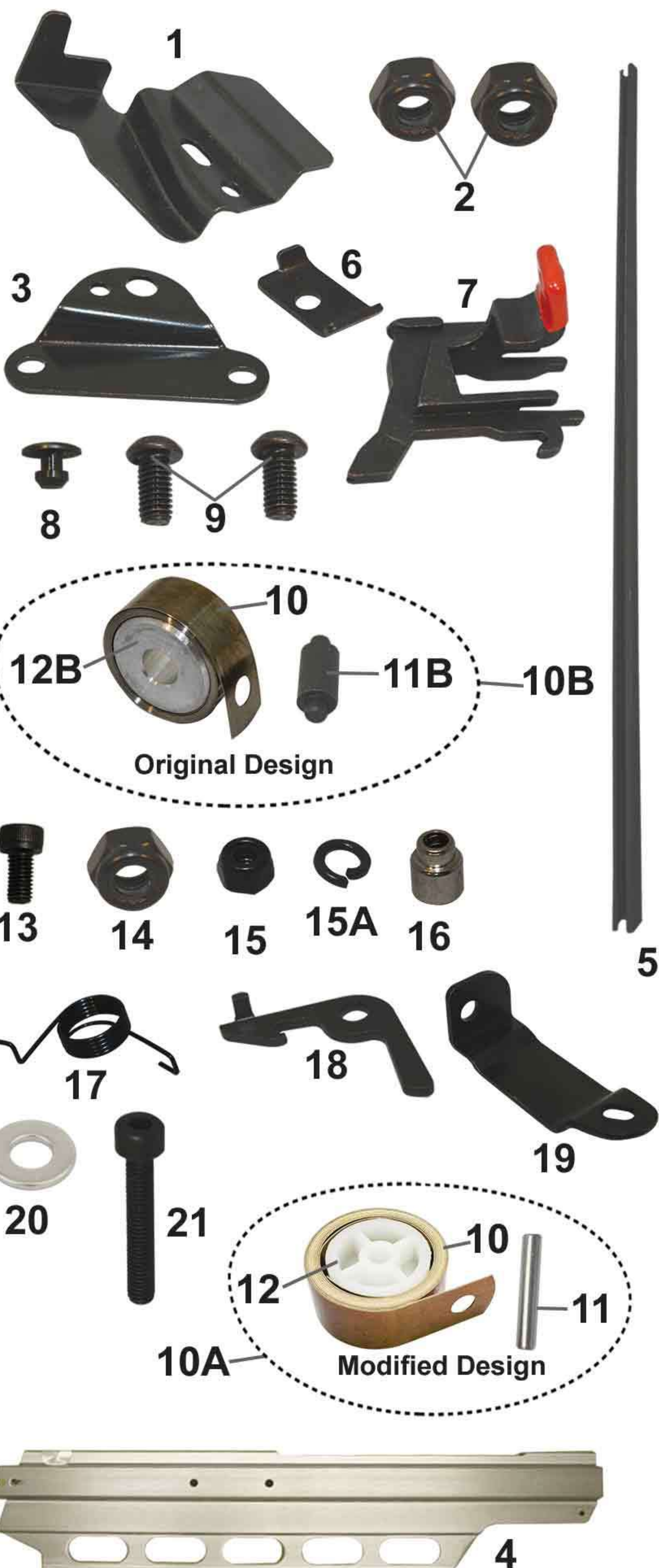

No.	Part #	Description
1	SP 885-827A-1	Nose Guard
2	SP 885-827A-2	Handle Arm Nut
3	SP 885-827A-3	Handle Arm Bracket
4	SP 885-827A-4	Bare Magazine
5	SP 885-827A-5	Steel Rail Insert
6	SP 885-827A-6	Nose Bracket
7	SP 885-827A-7	Nail Feeder
8	SP 885-827A-8	Ribbon Spring Pin
9	SP 885-827A-9	Handle Arm Bolt
10A	SP 885-827A-10A	Ribbon Spring Set (10/11/12)
10B	SP 885-827A-10B	Ribbon Spring Set (10/11B/12B)
13	SP 885-827A-13	Top Lever Bracket Bolt
14	SP 885-827A-14	Screw Nut
15	SP 885-827A-15	Stop Lever Nut
15A	SP 885-827A-15A	Spring Washer
16	SP 885-827A-16	Stop Lever Washer (2) Large
17	SP 885-827A-17	Stop Lever Spring
18	SP 885-827A-18	Stop Lever
19	SP 885-827A-19	Stop Lever Bracket
20	SP 885-827A-20	Stop Lever Washer (1) Small
21	SP 885-827A-21	Stop Lever Bolt
22	SP 885-827AB	Aluminum Magazine Assembly (Black)

10A Modified design available as a Spare Part
10B Original design included in all new Magazine Assemblies



MAGAZINE ASSEMBLIES

AL83-2-MAG ALUMINUM MAGAZINE ASSEMBLY FOR AL83-2 FRAMING NAILERS



Comes with Ribbon Spring + Nail Feeder Pre-Installed
Shoots up to 3-1/2" Long Nails
Dual ROLE Bracket Handle-Arm for One & Two Hole Nailer Models



METABO/HITACHI

METABO HPT O-RINGS & KIT



G877
Metabo HPT NR83

Part #	Nailer / Stapler Model #	Qty/Pk
SP 874-436	NR83A/AA, NV83A, NR65	1/pk
SP 874-820	NV45AB/2, NR83A, NT65A2	1/pk
SP 875-638	NR83A/AA, NV45AB/2, NT65GS, VH650	1/pk
SP 877-312	NR83A/AA, NR83A2(S)	1/pk
SP 877-313	NR83A/2 NR83A2(S)	1/pk
SP 877-314	NR83A/2/A, NV65A	1/pk
SP 877-316	NR83A/2, H90SB, NR83A2(S)	3/pk
SP 877-317	NR83A/2, NR90AD, NR90AE(S)	1/pk
SP 877-327	NR83A/A2, NR83A2(S)	2/pk
SP 877-368	NR83A/AA/AA2, NR65, NV83A	1/pk
SP 878-734	NR83A/AA, NR83A2(S)	1/pk
G877	O-Ring Kit - Includes all (11) of the above O-Rings	14/pk

METABO HPT O-RINGS & KIT



G865
Metabo HPT NR65

Part #	Nailer / Stapler Model #	Qty/Pk
SP 874-436	NR83A, NV83A and NR65AK	2/pk
SP 877-368	NR83A/AA/AA2, NR65/AK and NV83A	1/pk
SP 883-431	NR65AK, NV75AG and NV85AG	1/pk
SP 873-093	NR65AK and NT65	1/pk
SP 877-699	NR65AK, NT65 and NR90	1/pk
SP 878-863	NR65AK, NV83, NV75AG	1/pk
SP 878-885	NR65AK, NT65 and NR90	1/pk
SP 878-887	NR65AK, NT65 and NR90	1/pk
SP 878-888	NR65AK, NR90 and NT65	1/pk
SP 878-925	NR65AK, NT65 and NR90	2/pk
SP 882-874	NR65AK, NV75AG and NV85AG	2/pk
SP 883-992	NR65AK and NT65	1/pk
SP 981-317	NR65AK, NT65, NR90 and NV75AG	1/pk
G865	O-Ring Kit - Includes all (13) of the above O-Rings	16/pk

METABO HPT O-RINGS & KIT



G845
Metabo HPT NV45

Part #	Nailer / Stapler Model #	Qty/Pk
SP 872-645	NV45, NV83, NT65, NV65 and NR83	1/pk
SP 872-821	NV45, NV65, NV75A and NV83A	1/pk
SP 876-161	NV45, NV50 and NT65	3/pk
SP 876-167	NV45, NH451, NT50A and NT65	1/pk
SP 877-123	NV45, NH451, NT50A and NT65	1/pk
SP 877-124	NV45, NR90AA, NH451, NT50A and NT65	1/pk
SP 877-125	NV45, NV50 and NT65	1/pk
SP 877-126	NV45, NV50 and NT65	1/pk
SP 877-763	NV45, NR90 and NT65	1/pk
SP 877-764	NV45	1/pk
SP 884-112	NV45, NV83 and NT65	2/pk
SP 885-793	NV45, NV5010A and NV5021A	3/pk
SP 874-820	NV45, NV65, NR83 and NT50	2/pk
SP 875-638	NV45, NV65, NR83 and NT50	1/pk
SP 876-174	NV45, NV50 and NT65	1/pk
SP 878-734	NV45, NV50, NV65 and NR83	1/pk
G845	O-Ring Kit - Includes all (16) of the above O-Rings	22/pk

ORINGS

METABO / HITACHI

AFTERMARKET O-RING KIT



G877A
Metabo HPT NR83A

Part #	Qty/Kit
SP 872-821	4/pk
SP 874-436	2/pk
SP 874-820	2/pk
SP 875-638	6/pk
SP 875-645R	2/pk
SP 877-312	2/pk
SP 877-313	2/pk
SP 877-314	2/pk
SP 877-315	2/pk
SP 877-316	6/pk
SP 877-317	2/pk
SP 877-327	2/pk
SP 877-368	4/pk
SP 878-734	2/pk

AFTERMARKET O-RING KIT



G877-KC
Metabo HPT NR83A2

Part #	Qty/Kit
SP 872-645	4/pk
SP 874-436	2/pk
SP 874-820	2/pk
SP 875-638	2/pk
SP 875-645R	2/pk
SP 876-316	2/pk
SP 877-312	2/pk
SP 877-313	2/pk
SP 877-314	2/pk
SP 877-315	2/pk
SP 877-316	6/pk
SP 877-317	2/pk
SP 877-327	2/pk
SP 877-368	2/pk
SP 878-723	2/pk
SP 878-734	2/pk
SP 884-112	4/pk

AFTERMARKET TRIGGER O-RING KIT



G877-KT
Metabo HPT NR83A2

Part #	Qty/Kit
SP 872-645	4/pk
SP 874-436	2/pk
SP 874-820	2/pk
SP 875-638	2/pk
SP 875-645R	2/pk
SP 876-316	2/pk
SP 878-723	2/pk
SP 878-734	2/pk
SP 884-112	4/pk

METABO / HITACHI

AFTERMARKET O-RING KIT



G866
Metabo HPT NT65M2

Part #	Nailer / Stapler Model #	Qty/Pk
SP 873-093	NR65AK & NT65	2/pk
SP 877-763	NV45, NR90 & NT65	2/pk
SP 878-888	NR65AK, NR90 & NT65	2/pk
SP 883-992	NR65AK & NT65	2/pk
SP 885-666	NT65M2	2/pk
SP 885-668	NT65M2	2/pk

AFTERMARKET O-RING KIT



OS65V
Metabo HPT NV65AH

Part #	Description	Qty/Pk
SP 872-645	O-Ring	2/pk
SP 874-436	O-Ring	2/pk
SP 877-312	O-Ring	2/pk
SP 877-699	O-Ring	2/pk
SP 877-826	Feeder Shaft O-Ring	5/pk
SP 878-885	O-Ring	2/pk
SP 878-887	O-Ring	2/pk
SP 878-888	O-Ring	2/pk
SP 878-925	O-Ring	2/pk
SP 880-311	O-Ring	2/pk
SP 981-317	O-Ring	2/pk
SP 301-631	Compression Spring	1/pk
SP 880-446	Compression Spring	1/pk
SP 880-494	Stopper Spring	1/pk

AFTERMARKET O-RING KIT

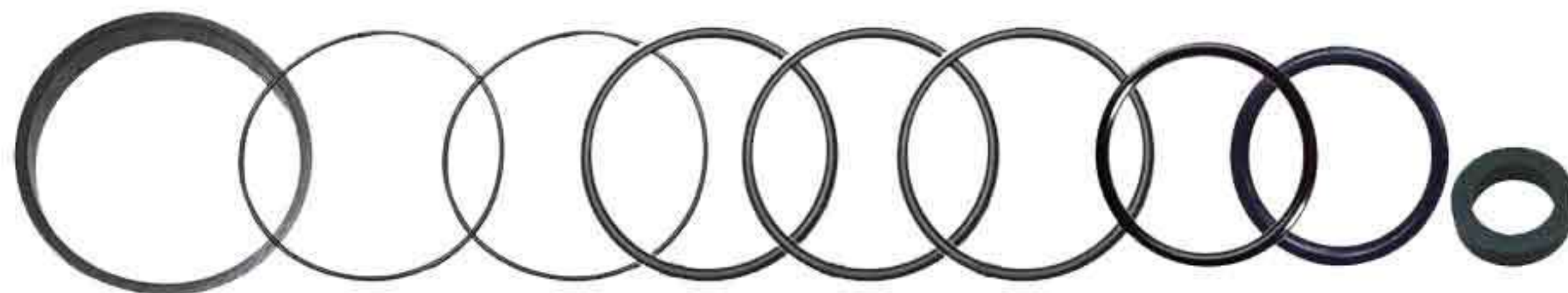

G508
Metabo HPT N5008AC / N5008AC2 / N5008ACP

Part #	Description	Qty/Pk
SP 876-174	Piston O-Ring	2/pk
SP 876-161	O-Ring	2/pk
SP 877-126	Cylinder O-Ring (D)	2/pk
SP 876-167	Cylinder O-Ring	2/pk
SP 877-124	Cylinder O-Ring (B)	2/pk
SP 877-125	Cylinder O-Ring (C)	2/pk
SP 877-123	Cylinder O-Ring (A)	2/pk
SP 875-638	O-Ring	2/pk
SP 878-734	Valve Packing O-Ring	2/pk
SP 874-820	Plunger O-Ring	2/pk

ORINGS

METABO / HITACHI

PISTON DRIVER O-RINGS



Part #	Nailer / Stapler Model #	Qty/Pk
SP 883-431	NR65AK/AK2/AK(S), NV75AG Driver	2/pk
SP 876-174	N5008AC, NT65, NV45 Driver	2/pk
SP 880-311	NV65AH, NT65AA, NV450AE Driver	2/pk
SP 931-835	VH650, NV65A/AB Driver	2/pk
SP 882-685	NT65MA2/MA3/MA4 Driver	2/pk
SP 884-958	NR90AE/AD/AF/AG Driver	2/pk
SP 882-282	NT50AE/AE(S), NT32AE/AE(S) Driver	2/pk
SP 877-368	NR83A/A2, NV75A/AG, NV65A/AG Driver	2/pk
SP 877-368Q	NR83A/A2, NV75A/AG, NV65A/AG Driver (Premium Quality)	1/pk
SP 877-368-OS-Q	Oversized NR83A/AA/AA2 (Premium Quality)	1/pk
SP 881-740	NT65AA / NT65MA	2/pk
SP 884-642	NP35A	2/pk
SP 885-668	NT65M2	2/pk

AFTERMARKET O-RINGS



Part #	Nailer / Stapler Model #	Qty/Pk
SP 872-645	NV45, NV83 and NT65	2/pk
SP 872-821	NV45, NV65 and NV83	2/pk
SP 873-093	NR65AK and NT65	2/pk
SP 874-436	NR83A/AA and NV83A	2/pk
SP 874-820	NV45AB/2 and NR83A	2/pk
SP 875-638	NR83A/AA and NV45AB/2	2/pk
SP 876-161	NV45, NV50 and NT65	2/pk
SP 876-167	NV45, NH451, NT50A and NT65	2/pk
SP 876-174	N5008AC, NV45, NV50 and NT65	2/pk
SP 876-316	NR83A2/A2(S) and NT65A3	2/pk
SP 877-123	NV45, NH451, NT50A and NT65	2/pk
SP 877-124	NV45, NR90AA, NT50A and NT65	2/pk
SP 877-125	NV45, NV50 and NT65	2/pk
SP 877-126	NV45, NV50 and NT65	2/pk
SP 877-312	NR83A/AA/A2(S)	2/pk
SP 877-313	NR83A/2	2/pk
SP 877-314	NR83A/2/AA, and NV65AA	2/pk
SP 877-315	NR83A, NV65 and NR90	1/pk
SP 877-316	NR83A/A2/A2(S) and H90S	3/pk
SP 877-317	NR83A/A2, NR90AE/AE(S) and NR90AD	1/pk
SP 877-327	NR83A/A2/A2(S)	2/pk
SP 877-368	NR83A/AA/AA2, NV65A/AG, NV75A/AG	2/pk
SP 877-368Q	NR83A/AA/AA2 (Premium Quality)	1/pk
SP 877-368-OS-Q	Oversized NR83A/AA/AA2 (Premium Quality)	1/pk
SP 877-699	NR65AK, NR90 and NT65	2/pk
SP 877-763	NV45, NR90, NT50 and NT65	2/pk
SP 877-764	NV45	2/pk

METABO / HITACHI

Part #	Nailer / Stapler Model #	Qty/Pk
SP 878-734	NR83A/AA	2/pk
SP 878-863	NR65AK and NV83	2/pk
SP 878-885	NR65AK and NT65	2/pk
SP 878-887	NR65AK and NT65	2/pk
SP 878-888	NR65AK, NR90 and NT65	2/pk
SP 878-925	NR65AK and NT65	2/pk
SP 878-723	NR83A2/A2(S) NT65A3	2/pk
SP 880-311	NV65AH Driver	2/pk
SP 882-282	NT50AE Driver	2/pk
SP 882-685	NT65MA2 / MA3 Driver	2/pk
SP 882-874	NR65AK	2/pk
SP 883-431	NR65AK Driver	2/pk
SP 883-992	NR65AK and NT65	2/pk
SP 884-112	NV45, NV83 and NT65	2/pk
SP 884-958	NR90AE Driver	2/pk
SP 885-793	NV45	2/pk
SP 931-835	VH650 Driver	2/pk
SP 981-317	NR65AK, NT65 and NR90	2/pk
SP 878-376	NV83	2/pk
SP 884-642	NP35A	2/pk
SP 884-989	NR90AE, NR90AD & NR90ADPR	2/pk
SP 881-740	NT65AA / MA, NV65AH	2/pk
SP 883-885	NV45AB2	2/pk
SP 885-668	NT65M2	1/pk
SP 887-840	NR83A5, NV83A3	2/pk
SP 889-112	NR83A5	1/pk
SP 888-422	NV75AN	2/pk
SP 888-587	NR38AK	2/pk
SP 883-405	NR83A5	5/pk
SP 885-666	NT65M2	2/pk
SP 888-419	NV65AN / NV75AN	2/pk
SP 888-420	NV75AN	2/pk
SP 888-425	NV75AN	2/pk
SP 888-426	NV75AN	2/pk
SP 888-459	NV75AN	2/pk

MAX

Part #	Nailer / Stapler Model #	Qty/Pk
SP HH11101	CN55	1/pk
SP HH11113	CN55, CN70, CN80 & CN100	1/pk
SP HH11119	CN55, CN70, CN80 & CN100	1/pk
SP HH11132	CN55, CN70, CN80 & CN100	1/pk
SP HH11138	CN55, CN70, CN80 & CN100	1/pk
SP HH11143	CN55, CN70 & CN80	1/pk
SP HH11151	CN55, CN70 & CN80	1/pk
SP HH11156	CN55, CN450R, HN75 & HN90	1/pk
SP HH11157	CN55, CN70 & CN80	1/pk
SP HH11159	CN55, CN70 & CN80	1/pk
SP HH11209	CN55, CN70 & CN80	1/pk
SP HH11901	CN55, CN70 & CN80	1/pk
SP HH11909	CN55	1/pk
SP HH19125	CN55, CN70 & CN80	1/pk
SP HH19139	CN70 & CN80	1/pk
SP HH19142	CN70 & CN80	1/pk
SP HH19195	CN70 & CN80	1/pk
SP HH19196	CN70 & CN80	1/pk
SP HH19197	CN55	1/pk
SP HH19198	CN55 & CN565	1/pk
SP HH12106	CN55, CN450R, CN445R	1/pk
SP HH12118	CN55, HN120, CN445R	1/pk
SP HH19218	CN890, SN883RH, SN883CH	2/pk
SP KN12613	CN890, SN883RH, SN883CH	2/pk
SP TA18161	NF235A-23-35	2/pk



Part #	Nailer / Stapler Model #	Qty/Pk
SP A00104Q	NS150A (Premium Quality)	1/pk



Part #	Nailer / Stapler Model #	Qty/Pk
SP RG162514-1	863S4, N64C, SDCN14B	2/pk
SP 174060	174061/175560	2/pk
SP 174053	MCN150	1/pk
SP 850607	RN45 Driver	2/pk
SP 850607-OS	RN45 Driver	2/pk
SP 851539Q	N100S/C, N130C, HR-65C-100/110/130	1/pk
SP 851439	N79 and N80	2/pk
SP 88998	RN46	2/pk
SP 149825	RN46	2/pk
SP 149829	RN46	2/pk
SP 149842	RN46	2/pk
SP 149883	RN46	2/pk
SP 850766	RN46	2/pk
SP 851606-S	RN46	2/pk
SP 174055	MCN150 & MCN250 (Piston Head Valve)	2/pk
SP 174056	OE P/N 174056 & S06S006700	2/pk
SP 174058	OE P/N 174058 & S06S004600	2/pk
SP 174073	OE P/N 174073, 1FA0103 & S06A010300	2/pk
SP 850242	MCN150 & MCN250 (Cap End)	2/pk
SP S06S003600	N66C, N66BC, N66BC-1 (Type 0), N66C-1 (72400000)	2/pk



Part #	Nailer / Stapler Model #	Qty/Pk
SP EA0233-OR	JoistPro 250XP	2/pk



Part #	Nailer / Stapler Model #	Qty/Pk
SP 502042	PF350S, PS150S-PP	2/pk
SP 502310	PF150S-PP	2/pk
SP 092971	F250S, F350S	2/pk
SP 403992	404600, 900420	2/pk
SP 900934	900420, 902200, 902600	2/pk



AFTERMARKET O-RING KIT

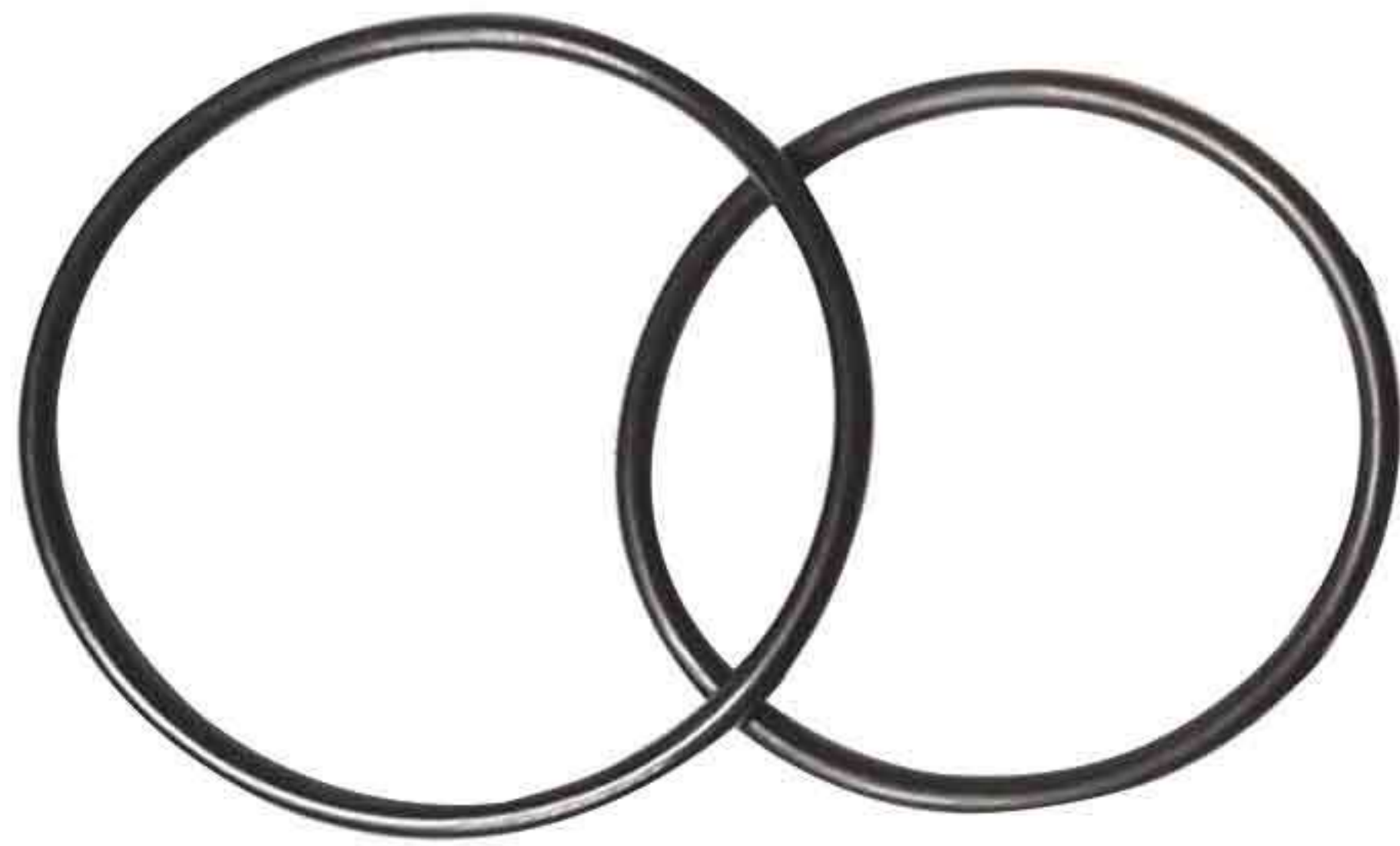

SP 9004200 RK1

Part #	Qty/Kit
SP 403992	1 Pc
SP 900934	1 Pc



AFTERMARKET O-RING KIT



SP BOS-RN46OR

Part #	Qty/Kit
SP 149828	1 Pc
SP 149842	1 Pc
SP 850766	1 Pc
SP 850607	2 Pcs
SP 850607-OS	1 Pc
SP 149829	1 Pc
SP 149883	1 Pc
SP 88998	1 Pc
SP N12112	2 Pcs

METABO / HITACHI

GASKETS & SET



No.	Part #	Nailer / Stapler Model #	Type
1	SP 877-325	NR83A/2, NR83AA, NV83A, NV75A, NV65AC	B
2	SP 877-326*	NR83A/NR83AA/A2, NV83A, NV75A, NV65AC	C
3	SP 877-329	NR83A/A2/A3, NV83A, NV75A	F
4	SP 877-331	NR83A/A2, NR83AA/2/3, NV83A, NV75A, NV65AC	D
5	SP 877-334	NR83A/A2, NV83A2, NV75A	A
	GS1	Gasket Set (includes all 5 of the above)	

* Interchangeable with 877-854

GASKETS & SET (PREMIUM QUALITY)







No.	Part #	Nailer / Stapler Model #	Type
1	SP 877-325Q	NR83A/2, NR83AA, NV83A, NV75A, NV65AC	B
2	SP 877-326Q*	NR83A/NR83AA/A2, NV83A, NV75A, NV65AC	C
3	SP 877-329Q	NR83A/A2/A3, NV83A, NV75A	F
4	SP 877-331Q	NR83A/A2, NR83AA/2/3, NV83A, NV75A, NV65AC	D
5	SP 877-334Q	NR83A/A2, NV83A2, NV75A	A
	GS1Q	Gasket Set (includes all 5 of the above)	

- ▶ Stainless Steel Construction
- ▶ Rubber Coated
- ▶ Rigid Structure

* Interchangeable with 877-854

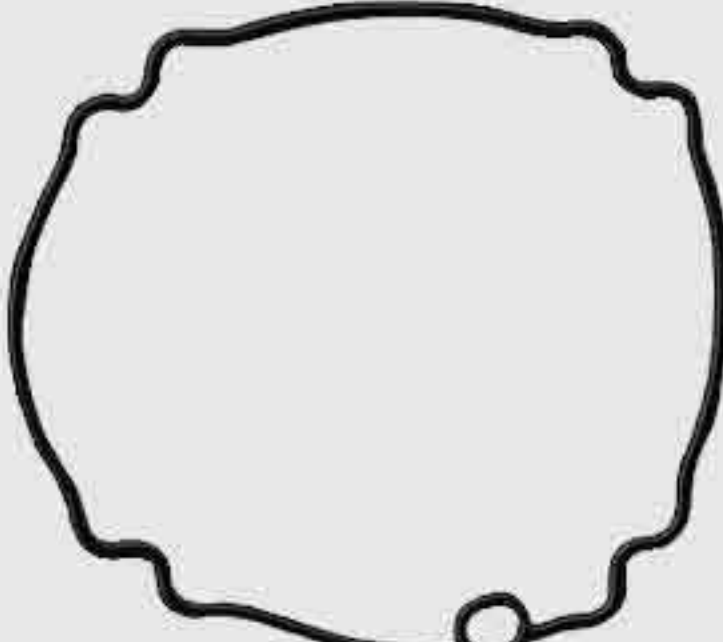
Part #	Nailer / Stapler Model #
 SP 883-881	Gasket(A) NV45AB2/AB2(S), NV45AE
 SP 876-737	Gasket(A) NV65A / VH650
 SP 876-713Q Premium Quality	Gasket(G) NV45AB2, NV45AB, NV45AB2(S), NV45AE

METABO / HITACHI

	Part #	Nailer / Stapler Model #
	SP 877-131Q Premium Quality	Gasket(D) NV45AB2, NV45AB, NV45AE, NT65A3
	SP 883-892Q Premium Quality	Gasket(F) NV45AB2, NV45AB, NV45AB2(S)
	SP 883-452Q Premium Quality	Gasket(B) NR65AK, NV75AG, NV85AG, NR65AK2, NR65AK2(S)
	SP 884-953	Gasket(A) NR90AE, NR90AE(S), NR90AD, NR90AF, NR90ADPR, NV90AG
	SP 877-767Q	Gasket(E) 890-159 Watte, NV45AB2, NV45AB2(S), NV45AE, NV45AA, NV45AB
	SP 883-678Q Premium Quality	Gasket(B) NR90AC3, NR90AE, NV75AG, NR90AC2, NR90AD, NR90ADPR
	SP 889-080	Gasket(H) NR83A5
	SP 876-178	Gasket(C) NT65A3 / N5010A / N5008AC
	SP 888-421	Gasket NV75AN

GASKETS



SP KN70142
Premium Quality
Cylinder Cap Seal
SN883 & SN890





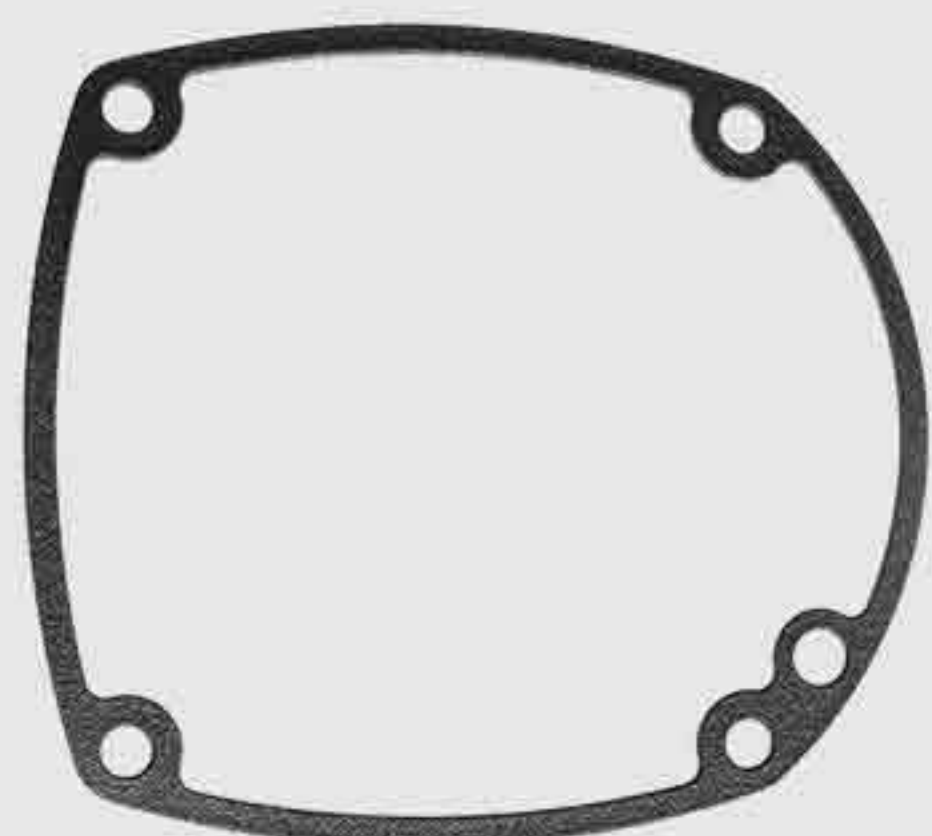



SP 501001
F350S





SP 174050Q
Premium Quality
Gasket - Frame / Deflect
N66C-1, N66BC-1, N75C-1,
CF15, MCN150, MCN250,
MCN250S

METABO / HITACHI

NUTS / WASHERS

	Part #	Nailer / Stapler Model #	Type	Qty/Pk
	SP 876-465	Nylon Nut NV45AB / AB2 / AB2(S), NR83A / A2 / A3	M4	5/Pk
	SP 877-371	Nut NR83A / A2 / A2(S), NR90AE, NT65MA, NV83A, NV75A	M5	5/Pk
	SP 880-081	Plain Washer NR83A2 / NR90AC / NV65AH / NV50AE		2/Pk
	SP 949-424	Plain Washer NR83A / A2 / A2(S), NV45AB, NV45AE, NT45A, NR65AK2	M5	5/Pk
	SP 949-454 SP 949-455	Spring Washer NR83A2 / NT65A2 / NR65AK2 Spring Washer NR83A2 / NV83A / VH650	M5 M6	3/Pk 3/Pk
	SP 963-837	Nylon Nut NR83AA/2/3	M6	5/Pk
	SP 949-555	Nut NR83A, NV83A, NV83A2, NV45AB2, NT65A, NT65A2	M5	2/Pk

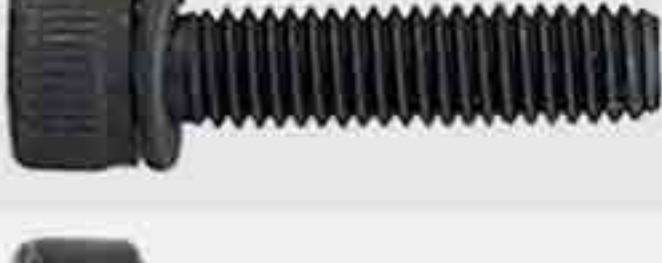
BOLTS

	Part #	Nailer / Stapler Model #	Type	Qty/Pk
	SP 878-426	Hex Bolt - Magazine to Nose NR83A/A2	M6x18	5/Pk
	SP 883-492	Hex Bolt - Nose to Body NR83A2/A3 / NV83A2	M8x20	4/Pk
	SP 883-507	Hex Bolt - NR83A2 / A2(S)	M6x25	4/Pk
	SP 949-650	Hex Socket HD Bolt NR83A2/A3	M4x15	5/Pk
	SP 949-652	Hex Bolt - Head Cap to body NR83A/AA / NV65AC / VH650 / NV83A	M6x25	4/Pk
	SP 949-655	Hex Bolt - Magazine (1 hole) Handle Arm to Body NR83A	M8x16	5/Pk
	SP 949-657	Hex Socket HD Bolt NR83A / NT65MA4 / NV65AH / NR90AC	M6x12	5/Pk
	SP 949-658	Hex Bolt - Air Inlet Cap to Handle NR83A/A3 / NV83A / NT65A / VH650	M5x18	3/Pk
	SP 949-662	Hex Bolt - Magazine (2 hole) Handle Arm to Body NR83A / NV45AB / NT50A / VH650	M5x25	5/Pk
	SP 949-757	Hex Bolt - Air Inlet Cap to Body NR83A / NT50AE / NT32AE / NT65MA4 / NV45AB2	M5x20	5/Pk
	SP 949-760	Hex Bolt - Nose to Body NR83A / NV75A	M8x25	4/Pk
	SP 949-824	Hex Socket HD Bolt NR83A/A2/A3/AA	M5x45	5/Pk
	SP 949-832	Hex Bolt - Top Cover to Head NR65AK / NV65AH	M6x45	3/Pk
	SP 875-650	Hex Bolt NR83A, NV83A2, NT65A, NV45AB2	M5x16	5/Pk
	SP 958-805	Bolt NV45AE, NV45AB, NV45AB2, NV45AB2(S)		10/Pk
	SP 878-647	Hex Socket HD Bolt NR65AK, NR83AA, NR90AA	M6x12	5/Pk

METABO / HITACHI

	Part #	Description	Nailer / Stapler Model #
	SP 877-307	Head Cap - Gasket Set	NR83A/2, NR83AA/2/3, NV83A/2
	SP 877-307K	Head Cap / Gasket / Exhaust Valve (w/Hole) Kit	NR83AA3, NR83A2(S) NR83A/2
	SP 877-307KN	Head Cap / Gasket / Exhaust Valve (w/o Hole) Kit	NR83AA3, NR83A2(S) NR83A/2, NV83A3, NV83A5
	SP 877-129	Head Cap	N5021A, N5024A, NT50A, NV50AA
	SP 877-852	Head Cap - Gasket Set	NR83A/2, NR83AA/2/3, NV83A/A2, NV65
	SP 876-711	Head Cap	NV45AB/AB2/AB2(S)/AE
	SP 876-711K	Head Cap Assembly Kit	NV45AB, NV5AB2, NV45AB2(S), NV45AE
	SP 878-026	Head Cap	N5010A, N5008AC, NT65A2
	SP 877-393Z	Nail Feeder	NR83A/NR83A2/NR83A3
	SP 877-393Z-BL	Nail Feeder (Black Long)	NR83A/A2/A2(S)/A3

PARTS

METABO / HITACHI

	Part #	Description	Nailer / Stapler Model #
	SP 877-330	Top Cover	NR83A/A2/A3, NV83A/A2/A3, NV65AA, NV75A
	SP 877-391Z	Pushing Lever	NR83A
	SP 877-391Z-F	Pushing Lever with Flush Nailer	NR83A
	SP 884-062	Pushing Lever (A)	NR83A
	SP 889-357	Pushing Lever (889-125)	NR83A5
	SP 889-357F	Pushing Lever with Flush Nailer (889-125)	NR83A5
	SP 889-336	Pushing Lever	NR83A5
	SP 884-063	Pushing Lever (B)	NR83A2/A2(S)
	SP 884-074	Pushing Lever	NR83A2S
	SP 887-902	Pushing Lever (B)	NR83A3/A3(S)

PARTS

METABO / HITACHI

	Part #	Description	Nailer / Stapler Model #
	SP 887-906	Pushing Lever (C)	NR83A3
	SP 887-906F	Pushing Lever (C) with Flush Nailer	NR83A3
	SP 878-418	Roller Pin	NR83A/A2/A2(S)
	SP 878-421 Replaces SP 878-422	Ribbon Spring Set	NR83A
	SP 883-440	Ribbon Spring	NR65AK, NR65A2(S), NR65AK2
	SP 888-637	Ribbon Spring	NR83AK
	SP 889-503	Ribbon Spring	N5010A, N5008AC/AC2/ACP, N5021A, N5024A2
	SP 884-060	Nose / Driver Guide For models having depth adjustment & raised spring holder	NR83A2/A2(S) Aluminum Magazine only fits this Nose
	SP 884-076	Nose Driver Guide For models that don't have raised spring holder	NR83A/A2/A2(S) without depth adjustment
	SP 887-773 Replaces (883-506)	Tool Body	NR83A/A2/A2(S)

METABO / HITACHI

	Part #	Description	Nailer / Stapler Model #
	SP 877-328	Exhaust Piece	NR83A / A2 / A2(S) / A5
	SP 878-419	Guard (A)	NR83A / NV45AA
	SP 884-061	Magazine Guard (A)	NR83A2 / A2(S), NR83A3
	SP 884-075	Guard Cover	NR83A2 / A2(S) / A3 / A3(S) / A5 / A5(S)
	SP 884-119	Safety Guard (B)	NR83A/2
	SP 884-064	Adjuster	NR83A2/A2(S)/A3, NV83A3
	SP 884-064Kit	Adjuster Kit	NR83A5 / A2
	SP 326-799	Adjuster	NR83A5/A2
	SP 882-907	Sleeve	NR65AK, NT65MA2
	SP 882-927	Head Valve (A)	NR65AK, NT65MA2
	SP 880-410	Head Valve (A)	NT32A, NT50A5, NT50AE2 NT50AE2(S), NV50AG, N3804A5, N3804AB3, N3804AB3(S)

PARTS

METABO / HITACHI

	Part #	Description	Nailer / Stapler Model #
	SP 888-418	Collar	NV65AN / NV75AN
	SP 881-760	Head Valve	NT65AA, NT65MA, NT65AH / AH2 / AH2M
	SP 884-068 (Replaces 877-810)	Cylinder	NR83A/A2/A2(S), NV83A/A2/A2(S), NV65AA, NV75A
	SP 889-086	Cylinder	NR83A5 / A5(S) / AA5, NV83A5
	SP 883-989	Cylinder	NR65AK, NR65AK(S), NV75AG, NR65AK2
	SP 887-774 SP 884-110	Exhaust Valve (w/o Hole) Exhaust Valve (w/Hole)	NR83A2/A3, NR83A2(S), NV83A3
	SP 878-539	Exhaust Valve	N5010A, NT65A/A2, N5008AC / AC2 / ACP
	SP 881-761	Exhaust Valve Rubber (A)	NT65AA, NT65MA, NV65AH, NV65AH2, NV65A2M
	SP 883-503	Ribbon Spring Set	NR90AE/AE(S)/AD/ADPR/AF
	SP 889-087	Cylinder Guide	NR83A5, NV83A5
	SP 877-310	Lower Cylinder Guide	NR83A/A2/A2S, NV83A/A2, NV65AA, NV75A

PARTS

METABO / HITACHI

	Part #	Description	Nailer / Stapler Model #
	SP 877-713	Feed Piston Cover	NV65AA / NV83A / A2 / A3 / A4 / A5
	SP 877-318	Support Collar (Upper)	NR83A2/A5, NV83A/A2
	SP 875-645R	Rubber Ball	NR83A/A2, NV83A/A2, NV45AB/AB2/AB2(S), NV75A
	SP 959-148	Steel Ball For Depth Adjuster	NR83A2/A2(S)
	SP 877-321	Cylinder Spring for Sealing Ring	NR83A/A2/A2S, NV83A/A2, NV65AA, NV75A
	SP 877-322	Sealing Ring for Compression Spring/ Base Washer	NR83A/A2/A2(S), NV83A/A2/A3, NV65AA, NV75A
	SP 877-398	Collar (10/pk)	NR83A/A2/A2(S)/A3
	SP 884-025	Roll Pin D3x45 (1/pk)	NR83A2/A2(S), NV83A2
	SP 949-866	Roll Pin D3x30 (10/pk)	NR83A/A2, NV83A2, NV45AB/AB2AB2(S)
	SP 949-535	Roll Pin D3x12 (10/pk)	NR65AK / AK(S) / AK2, N5008A1 / AA
	SP 876-203	Trigger Lever	NR83A/A2, NT65A/A2, NV83A/A2, NV45AB/AB2/AB2(S), NV50AA, NV65AC
	SP 899-089	Trigger Spring	NR83A5
	SP 949-776	Roll Pin (10/pk)	NV45AB/AB2/AB2(S), NV83A/A2, NR65AK
	SP 877-825	Feeder Shaft	NV45AB/AB2/AB2(S), NV83A/A2/A3

PARTS

METABO / HITACHI

	Part #	Description	Nailer / Stapler Model #
	SP 876-681	Main Stopper Spring	NV45AB/AB2/AB2(S)/AE, NV83A/A2/A3
	SP 877-761 SP 877-851	Feeder Spring Feeder Spring	NV45AB/AB2/AB2(S)/AE NV83A/A2, NV65AB/AC/AA
	SP 877-372	Spring	NV45AB/AB2/AB(S), NV83A/A2/A3
	SP 883-884	Nail Guide Shaft	NV45AB2/AB2(S)/AE
	SP 877-820	Lock Shaft	NV45AB/B2, NV83A/A2
	SP 875-642	Safety Plunger (B)	NV83A2, NV65AC
	SP 875-644 Replaces (887-777)	Trigger Valve Plate	NR83A/A2, NV83A/A2, NV45AB/AB2/AB2(S)
	SP 877-335	Trigger Valve Bushing	NR83A/A2, NV83A/A2, NV45AB/AB2/AB2(S)
	SP 878-121	Trigger Plunger	NR83A/A2/A2(S), NV83A/A2, NV45AB/AB2/AB2(S)/AE
	SP 884-114	Plunger (B)	NR83A2/A2(S)/A3
	SP 884-111	Plunger Valve Bushing	NR83A2/A2(S)/A3
	SP 884-113	Trigger Plunger (A)	NR83A2/A2(S)/A3
	SP 884-115	Plunger Spring (Bottom)	NR83A2/A2(S)/A3
	SP 875-643	Plunger Spring (Top)	NR83A/A2/A2(S), NV83A/A2, NV45AB/AB2/AB2(S)

PARTS

METABO / HITACHI

	Part #	Description	Nailer / Stapler Model #
	SP 889-103	Plunger (B) Spring	NR83A5
	SP 878-311	Air Inlet Cap	NR83A/A2, NV83A/A2/A3, NV65AC, VH650
	SP 889-079	Cap (B)	NR83A5
	GS845	Feeder Assmebly	NV45AB / AB2 / AB2(S)
	SP 301-631	Compression Spring	NV65AH, C18DMR, G12SE2
	SP 876-676	Compression Spring	VH650, NV65AB, NV45AA, NV50AA
	SP 877-337	Trigger Valve Bushing	NR83A, NV75A
	SP 877-338	Trigger Plunger (A)	NR83A, NV75A
	SP 877-365	Compression Spring	NR83A, NV83A2, NV65AA, NV75A
	SP 877-468	Compression Spring	NV45AB/AB2/AB2(S), NV65AB, NV83A2/A2/A3
	SP 877-826	Feeder Shaft Ring	NV45AB/AB2/AB2(S), NV83A/A2/A3

PARTS

METABO / HITACHI









	Part #	Description	Nailer / Stapler Model #
	SP 880-675	M6 x 20 Nylock High Tension Bolt with Thread Glue (4/pk)	NR65AK, NR65AK(S), NR65AK2, NV75AG
	SP 878-170	Valve Rubber Cover	NV45AB/AB2/AB2(S)/AE
	SP 881-751	Nose Cap (A)	NT65MA2 / A3, NT65A2 / A3
	SP 878-178	Compression Spring	NV45AB/AB2/AB2(S)/AE
	SP 880-175	Compression Spring	NR83A2/A2(S)/A3, NV65AH, NV50AE
	SP 880-446	Compression Spring	NV65AH, NV50AE, NV45AC, NV75AG
	SP 880-494	Stopper Spring	NV65AH, C10FCB
	SP 877-397	Stopper Spring (5/Pk)	NR83A/A2/A2S
	SP 889-081	Lock Pin	NR83A5
	SP 883-470	Compression Spring	NR65AK / NR65AK2 NR65AK(S)
	SP 884-067	Compression Spring	NR83A2 / NR83A2(S), NV83A3
	SP 884-077	Compression Spring	NR83A2 / A2(S) / A3
	SP 884-117	Compression Spring	NR83AA3 / NR83AA4

METABO / HITACHI

	Part #	Description	Nailer / Stapler Model #
	SP 889-094	Compression Spring	NR83A5
	SP 887-841	Compression Spring	NR83A2/A3/A3(S)
	SP 882-883	Feed Spring	NV75AG, NV85AG
	SP 887-852	Roll Pin D3 x 45 (1 pack)	NR83A/A2/A2(S)/A3
	SP 888-132	Cylinder Guide Ring	NR83A3/A3(S)
	SP 888-133	Cylinder	NR83A3/A3(S)
	SP 949-518	Roll Pin D3 x 18	NR83A2/A2(S)/A3, NT50AE2, NR90AD, NV45AC
	SP 877-339	Plunger (B)	NR83A / NR83AA2 NR83AA, NV75A
	SP 876-179	Top Cover	NT65A3, NV45AB/AB2/AB2(S)
	SP 876-168	Cylinder Plate	NT65A3, NV45AB/AB2/AB2(S)

PARTS

METABO / HITACHI

	Part #	Description	Nailer / Stapler Model #
	SP 877-486	Cylinder	NV45AB/AB2/AB2(S)/AE
	SP 876-172	Cylinder Spring	NV45AB/AB2/AB2(S)/AE, NT65A, NT50A
	SP 877-122	Cylinder Guide	NV45AB/AB2/AB2(S) NT65A, NT50A, NT65A3
	SP 878-151	Guard	NV45AB/AB2/AB2(S)
	NV45NOSE-K Replaces Metabo HPT 883-880	Nose Kit	NV45AB2/AB2(S)
	SP 883-880M Modified Nose		
	SP 883-887M Modified Nail Guide		
	SP 883-901M Modified Feeder		

* Three separate pieces make up the kit, and only interchange with each other. Cannot mix-n-match these parts with OEM Nose, Nail Guide or Feeder.

This kit gives the option and affordability, to keep your coil nailer up and running, in great working order and, when the kit is used on an NV45AB2, other OEM parts can then be installed.

METABO / HITACHI

	Part #	Description	Nailer / Stapler Model #
	SP 878-173	Nose Guard	NV45AB/AB2/AB2(S)/AE
	SP 883-888	Pushing Lever	NV45AB/AB2/AB2(S)/AE
	SP 878-171	Plunger (B)	NV45AB/AB2/AB2(S)/AE
	SP 878-152	Feed Piston	NV45AB/AB2/AB2(S)/AE
	SP 877-766	Feed Piston Cover	NV45AB/AB2/AB2(S)/AE
	SP 877-479	Magazine Bushing	NV45AB / NV45AB2 NV45AB2(S), NV65AB, NV45AE
	SP 883-885	Shaft Ring	NV45AB2/AB2(S)/AE
	SP 883-882	Adjuster	NV45AB/AB2/AB2(S)/AE
	SP 883-883	Adjuster Spring	NV45AE / NV45AB2 NV45AB2(S)
	SP 877-821	Guide Lock	NV45AB2 / NV45AB2(S) NV45AB, NV83A / NV83A2
	SP 877-856	Nail Feeder Set	NV83A / A2, N65AC

PARTS

METABO / HITACHI

	Part #	Description	Nailer / Stapler Model #
	SP 878-185	Main Nail Stopper	NV45AB / NV45AB2 NV45AB2(S)
	SP 878-186	Nail Stopper	NV45AB / NV45AB2 NV45AB2(S)
	SP 877-469	Nail Guide Cover	NV45AB / NV45AB2 NV45AB2(S), NV65AC NV65AB
	SP 883-899	Magazine Cover	NV45AB2 / NV45AB2(S)
	SP 883-900	Holder Cap	NV45AB2 / NV45AB2(S) NV45AE
	SP 949-230	Machine Screw M4X50	NV45AB2 / NV45AB2(S) NV45AE, NV83A
	SP 883-897	Holder Shaft	NV45AB2 / NV45AB2(S) NV45AE
	SP 880-398	Ratchet Spring	NV45AB2 / NV45AB2(S) NV45AE
	SP 883-896	Nail Holder	NV45AB2 / NV45AB2(S) NV45AE
	SP 883-895	Magazine	NV45AB2 / NV45AB2(S) NV45AE

PARTS

METABO / HITACHI

	Part #	Description	Nailer / Stapler Model #
	SP 883-898	Magazine Guard	NV45AB2 / NV45AB2(S)
	SP 878-213	Plate Nut	NV45AB / NV45AB2 NV45AB2(S) / NV45AE, NV65AB
	SP 878-175	Shingle Guide	NV45AB / NV45AB2 NV45AB2(S), NV45AE
	SP 888-153	Nose	NV83A4
	SP 878-614	Nylock Hex. Socket Hd. Bolt M4 X 8	NT50AD, NV83A4
	SP 887-724	Plunger Spring	NV83A3 / NV83A2, NV83AS
	SP 877-144	Feed Spring	NV83A2 / A3, NV65AB, NV65AC, NV50AA
	SP 887-727	Trigger Spring	NR83A2 / NR83A3 NR83A3S / NR83AA4, NV83A3
	SP 669-7846	Return Grommet	CG22EABSLP, CG22EADSLP, CG22EASSLP, CG24EASP, CG24EASPSL, CG27EASP, CG27EASPSL, CH22EAP2, CS40EA, CS40EA18, RB24EAP

PARTS

METABO / HITACHI

TRIGGER VALVE ASSEMBLY PART # SP-P1 (6 PARTS)

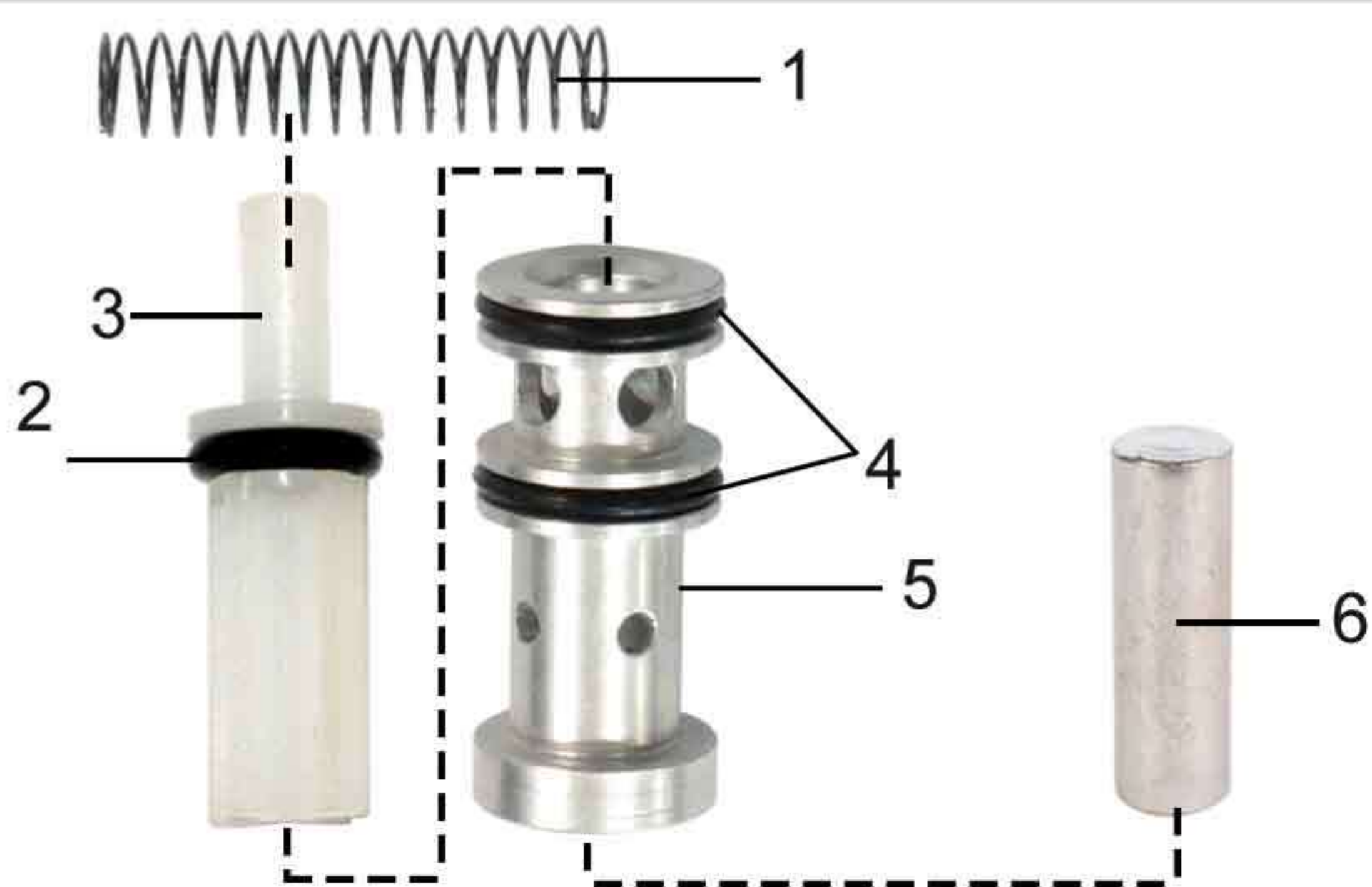

SP-P1

No.	Part #	Description
1	SP 875-643	Compression Spring
2	SP 874-436	Plunger O-Ring x2
3	SP 884-113	Trigger Plunger (SP 877-338)
4	SP 875-638	O-Ring x2
5	SP 877-337	Trigger Valve Stem
6	SP 877-339	Plunger (B)

TRIGGER VALVE ASSEMBLY PART # SP-P2 (7 PARTS)

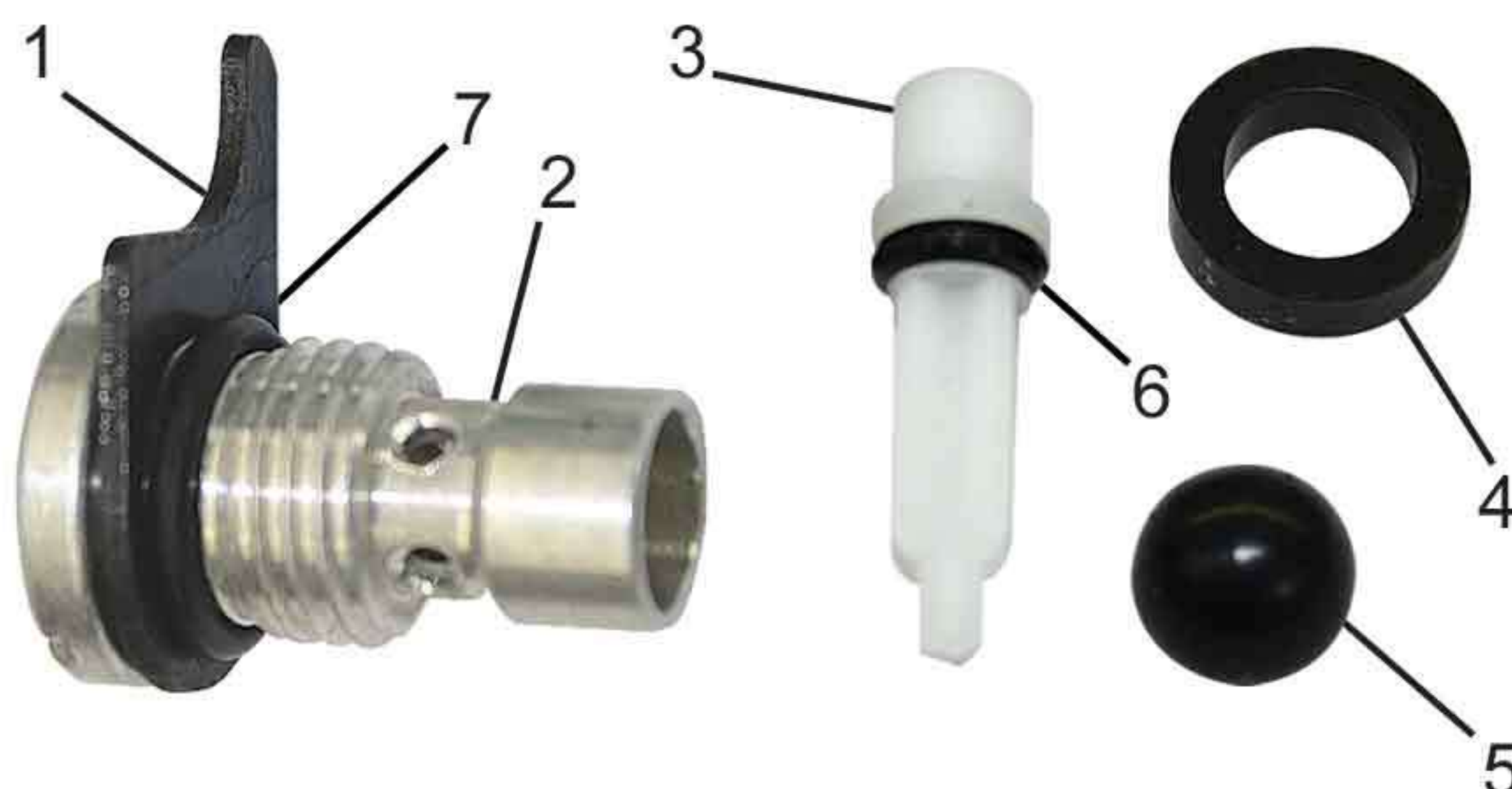

SP-P2

No.	Part #	Description
1	SP 875-644	Trigger Valve Plate
2	SP 877-335	Trigger Valve Bushing
3	SP 878-121	Trigger Plunger
4	SP 878-734	Valve Packing
5	SP 875-645R	Rubber Ball
5	SP 875-645	PU Ball
6	SP 874-820	Plunger O-Ring
7	SP 875-638	O-Ring

PLUNGER VALVE ASSEMBLY PART # SP-P3 (12 PARTS)

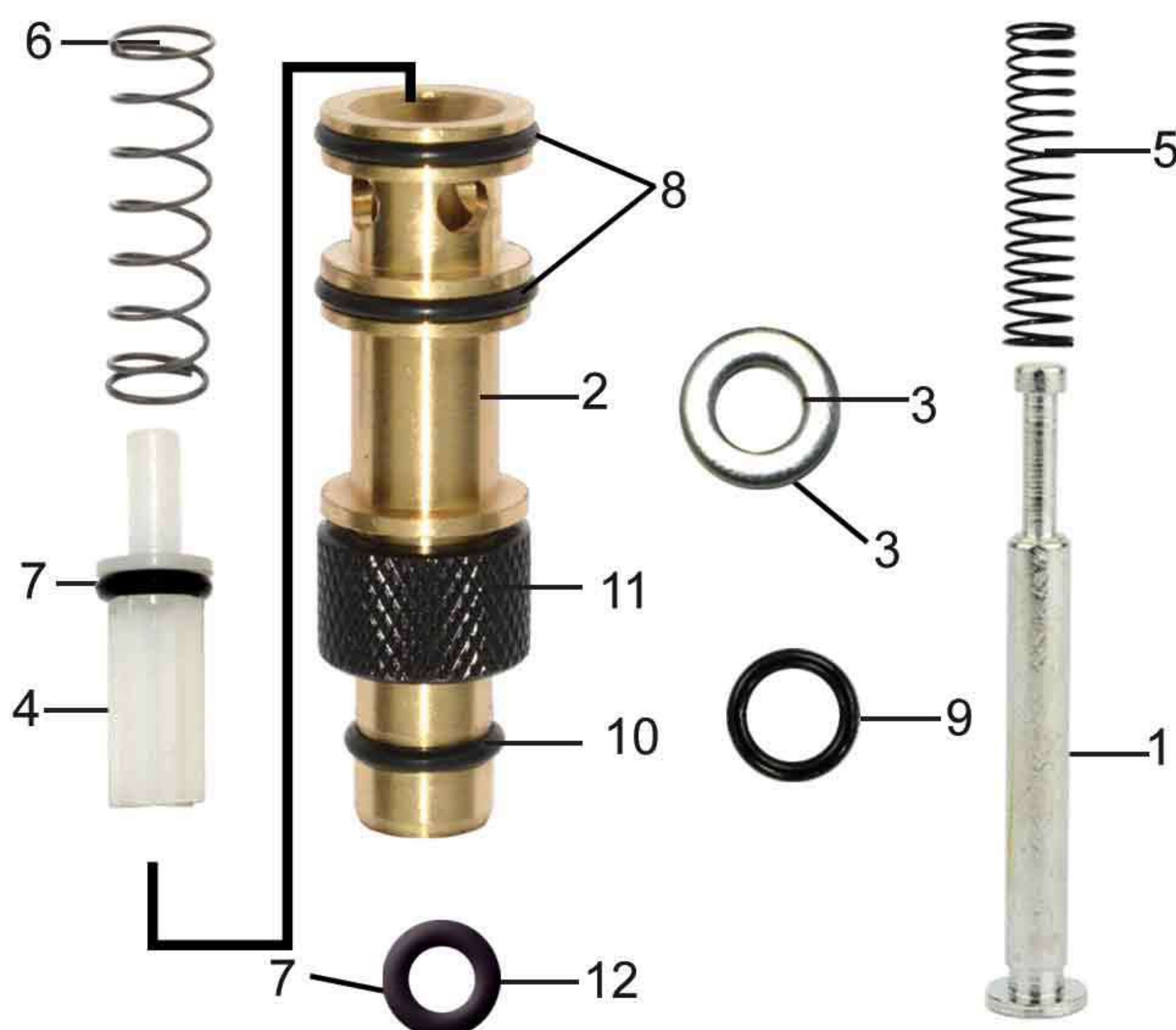

SP-P3

No.	Part #	Description
1	SP884-114	Plunger
2	SP884-111	Valve Bushing
3	SP949-424	Metal Washer
4	SP884-113	Trigger Plunger
5	SP884-115	Plunger Spring
6	SP875-643	Plunger Spring
7	SP874-436	Plunger O-Ring
8	SP884-112	O-Ring x 2
9	SP872-645	O-Ring x 2
10	SP876-316	O-Ring
11	SP884-116	Valve Sleeve
12	SP878-723	O-Ring





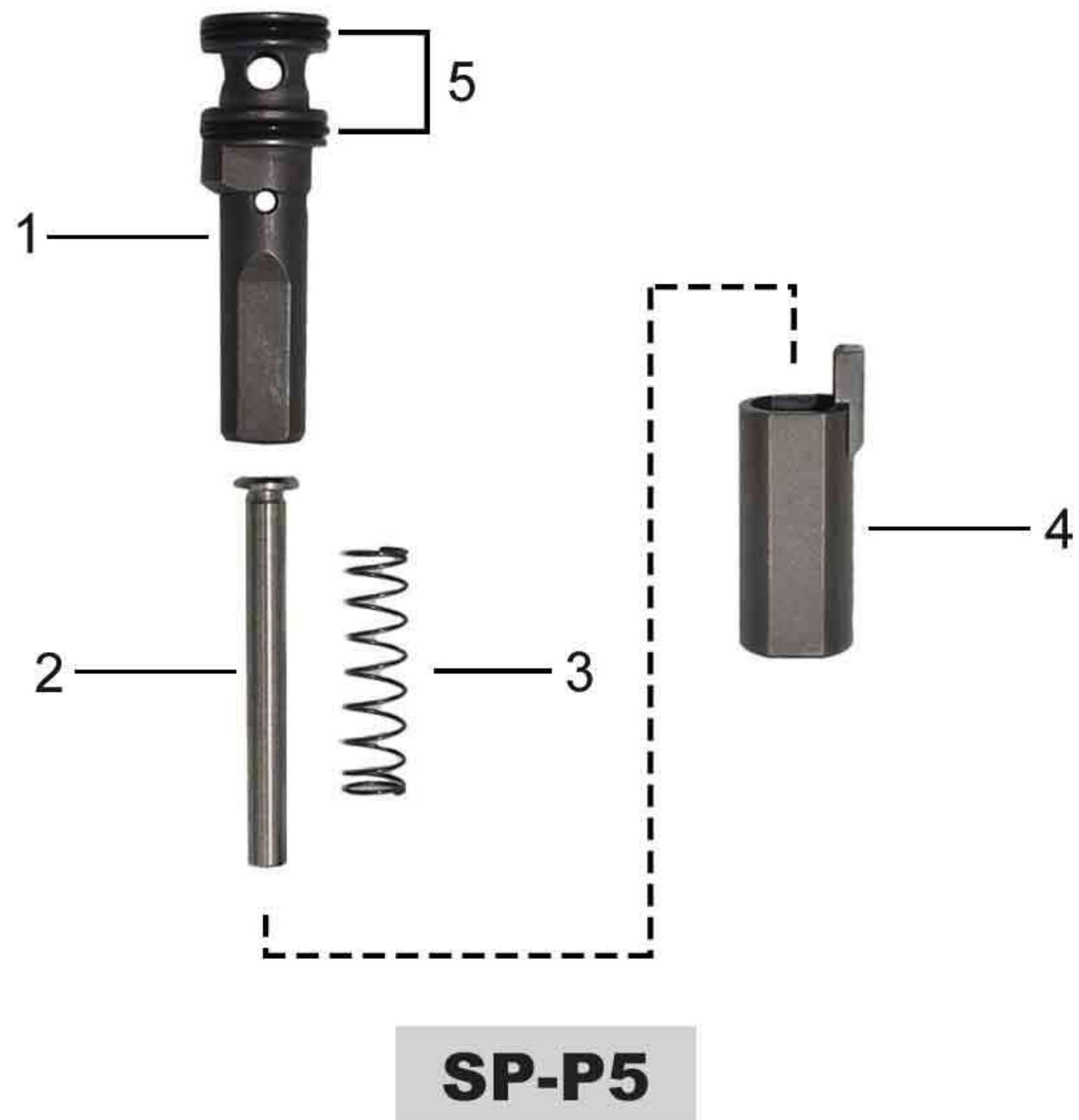

METABO / HITACHI

TRIGGER VALVE ASSEMBLY PART # SP-P5 (5 PARTS)



No.	Part #	Description
1	889-088	Valve Bushing
2	889-102	Plunger
3	889-103	Plunger Spring
4	889-099	Pushing Lever
5	884-112	O-Ring

METABO / HITACHI PISTON DRIVERS

	Part #	Nailer / Stapler Model #
	SP 877-323*	NR83A/A2/A3/A2(S)/A3(S)
	SP 877-323C*	NR83A/A2/A3/A2(S)/A3(S) (Japanese Carbide Driver)
	SP 877-323U*	NR83A/A2/A3/A2(S)/A3(S) (USA S7 Steel Driver)
	885-915	NR83A/A2/A3/A2(S)/A3(S) (Made in Japan) - Original Metabo HPT Driver
	SP 885-915*	NR83A/A2/A3/A2(S)/A3(S) (Replaces 877-323)
	SP 878-630	NR83AA (Replaces 878-301)
	SP 883-510*	NR83AA2/AA3

* Driver with UNI-LOK®

METABO / HITACHI PISTON BUMPERS

	Part #	Nailer / Stapler Model #
	SP 878-303	NR83A/A2 (Standard Ivory Color) - PU Material
	SP 878-303RED	NR83A, NR83A2, NR83A2(S) - 883-511, 878649, 877376 (German Material Red)
	SP 878-303G	NR83A/A2 (Premium Green Color) - PU Material
	SP 878-649	NR83AA Short (B) - PU Material

NR83 PARTS

METABO/HITACHI O-RINGS & KITS



SP 874-436	SP 877-327	SP 877-368Q
SP 874-820	SP 877-368	SP 877-368-OS
SP 875-638	SP 874-436	SP 877-368-OS-Q
SP 877-312	SP 877-368	SP 878-723
SP 877-313	SP 872-645	
SP 877-314	SP 874-820	
SP 877-316	SP 875-638	
SP 877-317	SP 878-734	

METABO HPT O-RINGS & KIT



G877
Metabo HPT NR83

Part #	Nailer / Stapler Model #	Qty/Pk
SP 874-436	NR83A/AA	1/pk
SP 874-820	NR83A	1/pk
SP 875-638	NR83A/AA	1/pk
SP 877-312	NR83A/AA/A2(S)	1/pk
SP 877-313	NR83A/2/A2(S)	1/pk
SP 877-314	NR83A/2/A	1/pk
SP 877-316	NR83A/2/A2(S)	3/pk
SP 877-317	NR83A/2	1/pk
SP 877-327	NR83A/A2/A2(S)	2/pk
SP 877-368	NR83A/AA/AA2	1/pk
SP 878-734	NR83A/AA/A2(S)	1/pk
G877	O-Ring Kit - Includes all (11) of the above O-Rings	14/pk

NR83 PARTS

METABO / HITACHI

AFTERMARKET O-RING KIT



G877A
Metabo HPT NR83A

Part #	Qty/Kit
SP 872-821	4/pk
SP 874-436	2/pk
SP 874-820	2/pk
SP 875-638	6/pk
SP 875-645R	2/pk
SP 877-312	2/pk
SP 877-313	2/pk
SP 877-314	2/pk
SP 877-315	2/pk
SP 877-316	6/pk
SP 877-317	2/pk
SP 877-327	2/pk
SP 877-368	4/pk
SP 878-734	2/pk

AFTERMARKET O-RING KIT



G877-KC
Metabo HPT NR83A2

Part #	Qty/Kit
SP 872-645	4/pk
SP 874-436	2/pk
SP 874-820	2/pk
SP 875-638	2/pk
SP 875-645R	2/pk
SP 876-316	2/pk
SP 877-312	2/pk
SP 877-313	2/pk
SP 877-314	2/pk
SP 877-315	2/pk
SP 877-316	6/pk
SP 877-317	2/pk
SP 877-327	2/pk
SP 877-368	2/pk
SP 878-723	2/pk
SP 878-734	2/pk
SP 884-112	4/pk

AFTERMARKET TRIGGER O-RING KIT



G877-KT
Metabo HPT NR83A2

Part #	Qty/Kit
SP 872-645	4/pk
SP 874-436	2/pk
SP 874-820	2/pk
SP 875-638	2/pk
SP 875-645R	2/pk
SP 876-316	2/pk
SP 878-723	2/pk
SP 878-734	2/pk
SP 884-112	4/pk

METABO/HITACHI GASKETS & SETS

GASKETS & SET

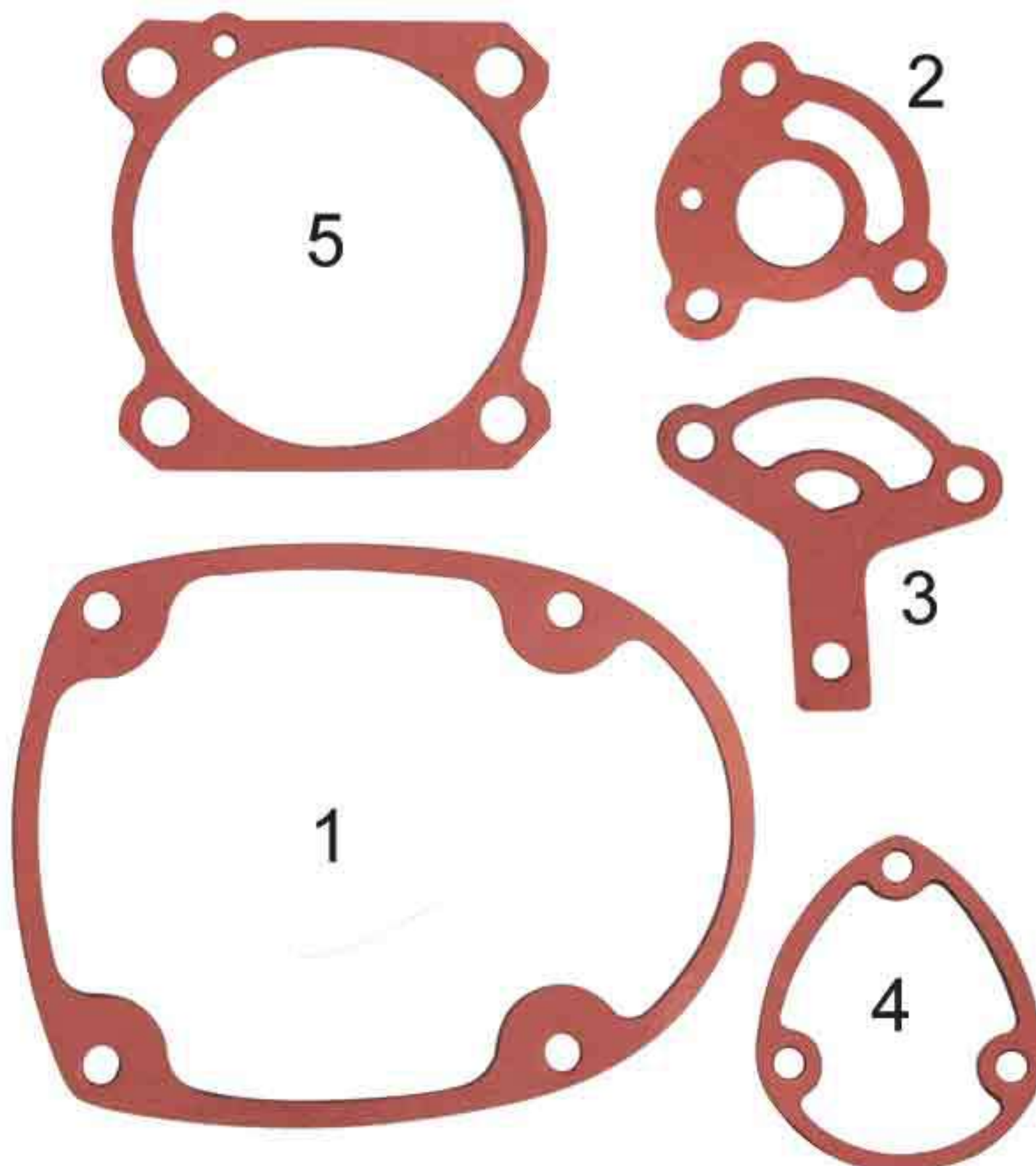

No.	Part #	Nailer / Stapler Model #	Type
1	SP 877-325	NR83A / 2, NR83AA	B
2	SP 877-326*	NR83A, NR83AA/A2	C
3	SP 877-329	NR83A / A2 / A3	F
4	SP 877-331	NR83A / A2, NR83AA / 2 / 3	D
5	SP 877-334	NR83A / A2	A
	GS1	Gasket Set (includes all 5 of the above)	

* Interchangeable with 877-854

GASKETS & SET (PREMIUM QUALITY)

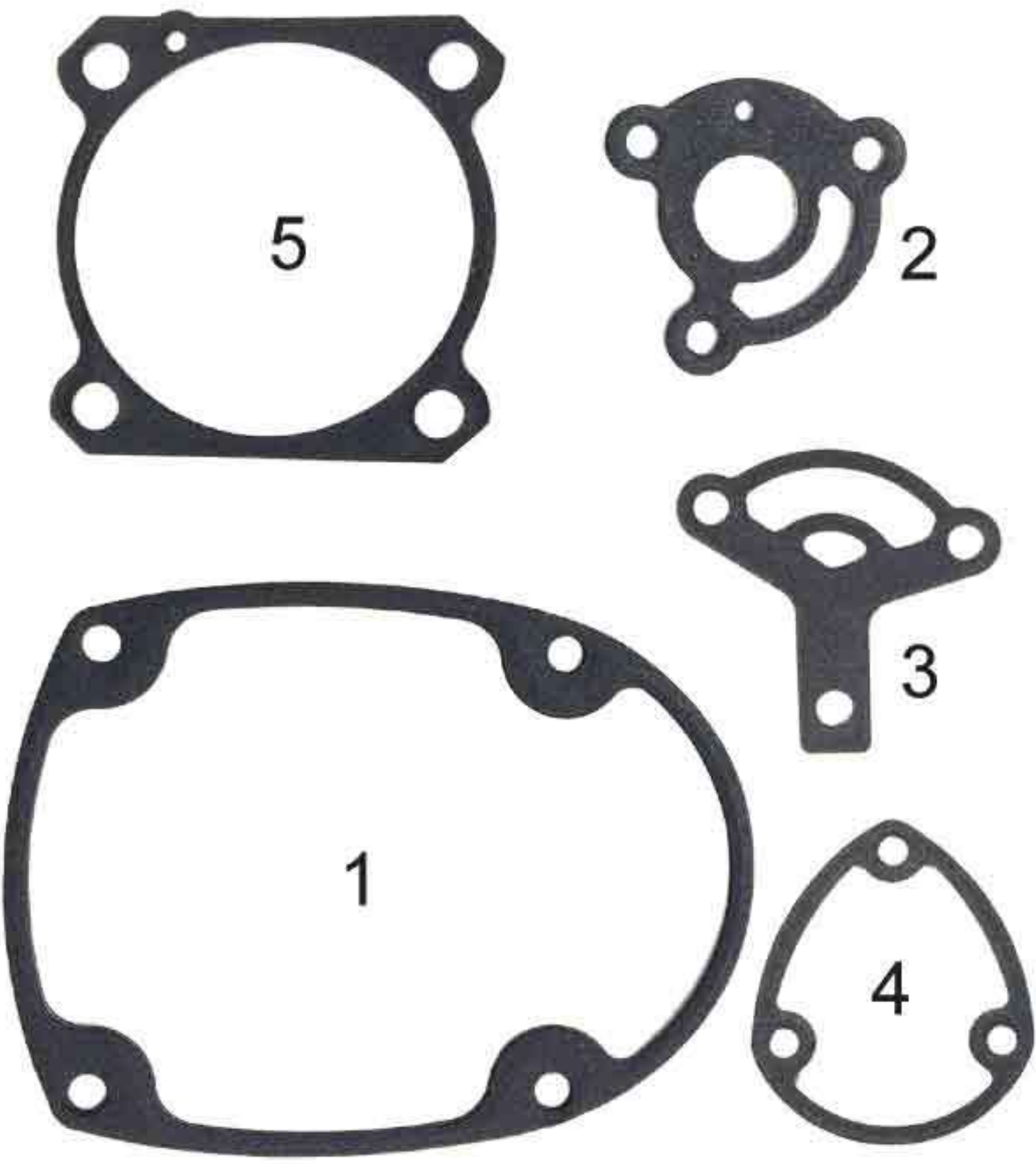

No.	Part #	Nailer / Stapler Model #	Type
1	SP 877-325Q	NR83A / 2, NR83AA	B
2	SP 877-326Q*	NR83A, NR83AA / A2	C
3	SP 877-329Q	NR83A / A2 / A3	F
4	SP 877-331Q	NR83A / A2, NR83AA / 2 / 3	D
5	SP 877-334Q	NR83A / A2	A
	GS1Q	Gasket Set (includes all 5 of the above)	

- ▶ Stainless Steel Construction
- ▶ Rubber Coated
- ▶ Rigid Structure

* Interchangeable with 877-854

GASKET











SP 889-080 Gasket(H) NR83A5

NR83 PARTS

METABO / HITACHI





NUTS / WASHERS





	Part #	Nailer / Stapler Model #	Type	Qty/Pk
	SP 876-465	Nylon Nut NR83A / A2 / A3	M4	5/Pk
	SP 877-371	Nut NR83A / A2 / A2(S)	M5	5/Pk
	SP 880-081	Plain Washer NR83A2		2/Pk
	SP 949-424	Plain Washer NR83A / A2 / A2(S)	M5	5/Pk
	SP 949-453 SP 949-454 SP 949-455	Spring Washer NR83A2 Spring Washer NR83A2 Spring Washer NR83A2	M3 M5 M6	5/Pk 3/Pk 3/Pk
	SP 963-837	Nylon Nut NR83AA/2/3	M6	5/Pk
	SP 949-555	Nut NR83A	M5	2/Pk

BOLTS

	Part #	Nailer / Stapler Model #	Type	Qty/Pk
	SP 878-426	Hex Bolt - Magazine to Nose NR83A/A2	M6x18	5/Pk
	SP 883-492	Hex Bolt - Nose to Body NR83A2/A3	M8x20	4/Pk
	SP 883-507	Hex Bolt - NR83A2 / A2(S)	M6x25	4/Pk
	SP 949-650	Hex Socket HD Bolt NR83A2/A3	M4x15	5/Pk
	SP 949-652	Hex Bolt - Head Cap to body NR83A/AA	M6x25	4/Pk
	SP 949-655	Hex Bolt - Magazine (1 hole) Handle Arm to Body NR83A	M8x16	5/Pk
	SP 949-657	Hex Socket HD Bolt NR83A	M6x12	5/Pk
	SP 949-658	Hex Bolt - Air Inlet Cap to Handle NR83A/A3	M5x18	3/Pk
	SP 949-662	Hex Bolt - Magazine (2 hole) Handle Arm to Body NR83A	M5x25	5/Pk
	SP 949-757	Hex Bolt - Air Inlet Cap to Body NR83A	M5x20	5/Pk
	SP 949-760	Hex Bolt - Nose to Body NR83A	M8x25	4/Pk
	SP 949-824	Hex Socket HD Bolt NR83A/A2/A3/AA	M5x45	5/Pk
	SP 875-650	Hex Bolt NR83A	M5x16	1/Pk

METABO/HITACHI PINS / SHAFTS / SPRINGS







	Part #	Description	Nailer / Stapler Model #
	SP 884-025	Roll Pin D3X45 1/pk	NR83A2/A2(S)
	SP 949-866	Roll Pin D3X30 10/pk	NR83A/A2
	SP 887-852	Roll Pin D3 x 45 1/pk	NR83A/A2/A2(S)/A3
	SP 949-518	Roll Pin D3 x 18	NR83A2/A2(S)/A3

	Part #	Description	Nailer / Stapler Model #
	SP 878-121	Trigger Plunger	NR83A/A2/A2(S)
	SP 884-114	Plunger (B)	NR83A2/A2(S)/A3
	SP 884-113	Trigger Plunger (A)	NR83A2/A2(S)/A3
	SP 877-338	Trigger Plunger (A)	NR83A
	SP 877-339	Trigger Plunger (B)	NR83A/AA/AA2

	Part #	Description	Nailer / Stapler Model #
	SP 884-115	Plunger Spring (Bottom)	NR83A2/A2(S)/A3
	SP 875-643	Plunger Spring (Top)	NR83A/A2/A2(S)
	SP 889-103	Plunger (B) Spring	NR83A5
	SP 877-365	Compression Spring	NR83A
	SP 880-175	Compression Spring	NR83A2/A2(S)/A3
	SP 884-067	Compression Spring	NR83A2/A2(S)

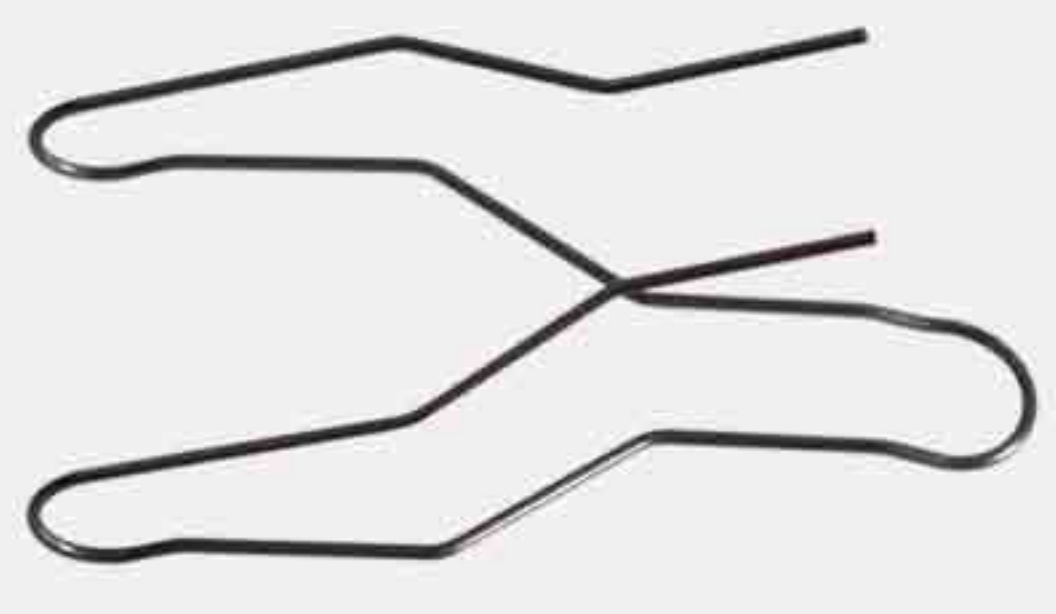
NR83 PARTS

METABO / HITACHI PINS / SHAFTS / SPRINGS

	Part #	Description	Nailer / Stapler Model #
	SP 884-077	Compression Spring	NR83A2/A2(S)/A3
	SP 884-117	Compression Spring	NR83AA3/AA4
	SP 887-841	Compression Spring	NR83A2/A3/A3(S)
	SP 877-321	Cylinder Spring for Sealing Ring	NR83A/A2/A2S
	SP 877-727	Trigger Spring	NR83A2/A3/A3S/AA4
	SP 877-397	Stopper Spring (5/Pk)	NR83A/A2/A2S
	SP 889-081	Lock Pin	NR83A5
	SP 889-094	Compression Spring	NR83A5

NR83 PARTS

METABO / HITACHI

	Part #	Description	Nailer / Stapler Model #
	SP 877-307	Head Cap - Gasket Set	NR83A/2, NR83AA/2/3
	SP 877-852	Head Cap - Gasket Set	NR83A/2, NR83AA/2/3
	SP 877-307K	Head Cap / Gasket / Exhaust Valve (w/Hole) Kit	NR83AA3, NR83A2(S) NR83A/2
	SP 877-307KN	Head Cap / Gasket / Exhaust Valve (w/o Hole) Kit	NR83AA3, NR83A2(S) NR83A/2, NV83A3, NV83A5
	SP 877-393Z	Nail Feeder	NR83A/NR83A2/NR83A3
	SP 877-393Z-B	Nail Feeder (Black)	NR83A/A2/A2(S)/A3
	SP 877-393Z-BL	Nail Feeder (Black Long)	NR83A/A2/A2(S)/A3
	SP 877-330	Top Cover	NR83A/A2/A3

NR83 PARTS

METABO / HITACHI

	Part #	Description	Nailer / Stapler Model #
	SP 877-931Z	Pushing Lever	NR83A
	SP 889-357	Pushing Lever (889-125)	NR83A5
	SP 889-357F	Pushing Lever with Flush Nailer (889-125)	NR83A5
	SP 889-336	Pushing Lever	NR83A5
	SP 884-062	Pushing Lever (A)	NR83A
	SP 884-063	Pushing Lever (B)	NR83A2/A2(S)
	SP 884-074	Pushing Lever	NR83A2S
	SP 884-074M	Pushing Lever	NR83A/A2/A2(S)
	SP 887-902	Pushing Lever (B)	NR83A3/A3(S)
	SP 878-421 Replaces SP 878-422	Ribbon Spring Set	NR83A
	SP 878-421A	Ribbon Spring Set with Aluminum Wheel	NR83A

NR83 PARTS

METABO / HITACHI

	Part #	Description	Nailer / Stapler Model #
	SP 887-906	Pushing Lever (C)	NR83A3
	SP 887-906F	Pushing Lever (C) with Flush Nailer	NR83A3
	SP 878-418	Roller Pin	NR83A/A2/A2(S)
	SP 888-637	Ribbon Spring	NR83AK
	SP 884-060	Nose / Driver Guide For models having depth adjustment & raised spring holder	NR83A2/A2(S) Aluminum Magazine only fits this Nose
	SP 884-076	Nose Driver Guide For models that don't have raised spring holder	NR83A/A2/A2(S) without depth adjustment
	SP 887-773 Replaces (883-506)	Nose Driver Guide For models that don't have raised spring holder	NR83A/A2/A2(S)
	SP 877-328	Exhaust Piece	NR83A / A2 / A2(S) / A5











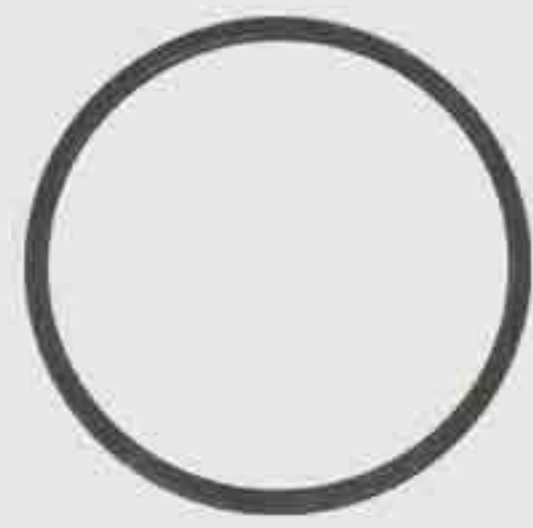

NR83 PARTS

METABO / HITACHI

	Part #	Description	Nailer / Stapler Model #
	SP 878-419	Guard (A)	NR83A
	SP 884-061	Magazine Guard (A)	NR83A2 / A2(S), NR83A3
	SP 884-119	Safety Guard (B)	NR83A/2
	SP 884-064	Adjuster	NR83A2/A2(S)/A3
	SP 884-064Kit	Adjuster Kit	NR83A5 / A2
	SP 326-799	Adjuster	NR83A5/A2
	SP 884-068 Replaces (877-810)	Cylinder	NR83A/A2/A2(S)
	SP 889-086	Cylinder	NR83A5 / A5(S) / AA5
	SP 887-774	Exhaust Valve (w/o HOLE)	NR83A2/A3
	SP 889-087	Cylinder Guide	NR83A5
	SP 877-310	Lower Cylinder Guide	NR83A/A2/A2S

NR83 PARTS

METABO / HITACHI

	Part #	Description	Nailer / Stapler Model #
	SP 877-318	Support Collar (Upper)	NR83A2/A5
	SP 875-645R	Rubber Ball	NR83A/A2
	SP 959-148	Steel Ball For Depth Adjuster	NR83A2/A2(S)
	SP 877-321	Cylinder Spring for Sealing Ring	NR83A/A2/A2S
	SP 877-322	Sealing Ring for Compression Spring/ Base Washer	NR83A/A2/A2(S)
	SP 877-398	Collar (10/pk)	NR83A/A2/A2(S)/A3
	SP 884-025	Roll Pin D3x45 (1/pk)	NR83A2/A2(S)
	SP 949-866	Roll Pin D3x30 (10/pk)	NR83A/A2
	SP 876-203	Trigger Lever	NR83A/A2
	SP 899-089	Trigger Spring	NR83A5
	SP 875-644 Replaces (887-777)	Trigger Valve Plate	NR83A/A2
	SP 877-335	Trigger Valve Bushing	NR83A/A2

NR83 PARTS

METABO / HITACHI



	Part #	Description	Nailer / Stapler Model #
	SP 878-121	Trigger Plunger	NR83A/A2/A2(S)
	SP 884-114	Plunger (B)	NR83A2/A2(S)/A3
	SP 884-111	Plunger Valve Bushing	NR83A2/A2(S)/A3
	SP 884-113	Trigger Plunger (A)	NR83A2/A2(S)/A3
	SP 884-115	Plunger Spring (Bottom)	NR83A2/A2(S)/A3
	SP 875-643	Plunger Spring (Top)	NR83A/A2/A2(S)
	SP 889-103	Plunger (B) Spring	NR83A5
	SP 878-311	Air Inlet Cap	NR83A/A2
	SP 889-079	Cap (B)	NR83A5
	SP 877-337	Trigger Valve Bushing	NR83A
	SP 877-338	Trigger Plunger (A)	NR83A
	SP 877-365	Compression Spring	NR83A

METABO / HITACHI

	Part #	Description	Nailer / Stapler Model #
	SP 880-175	Compression Spring	NR83A2/A2(S)/A3
	SP 877-397	Stopper Spring (5/Pk)	NR83A/A2/A2S
	SP 889-081	Lock Pin	NR83A5
	SP 884-067	Compression Spring	NR83A2 / NR83A2(S)
	SP 884-077	Compression Spring	NR83A2 / A2(S) / A3
	SP 884-117	Compression Spring	NR83AA3 / NR83AA4
	SP 889-094	Compression Spring	NR83A5
	SP 887-841	Compression Spring	NR83A2/A3/A3(S)
	SP 887-852	Roll Pin D3 x 45 (1 pack)	NR83A/A2/A2(S)/A3
	SP 888-132	Cylinder Guide Ring	NR83A3/A3(S)
	SP 888-133	Cylinder	NR83A3/A3(S)

NR83 PARTS

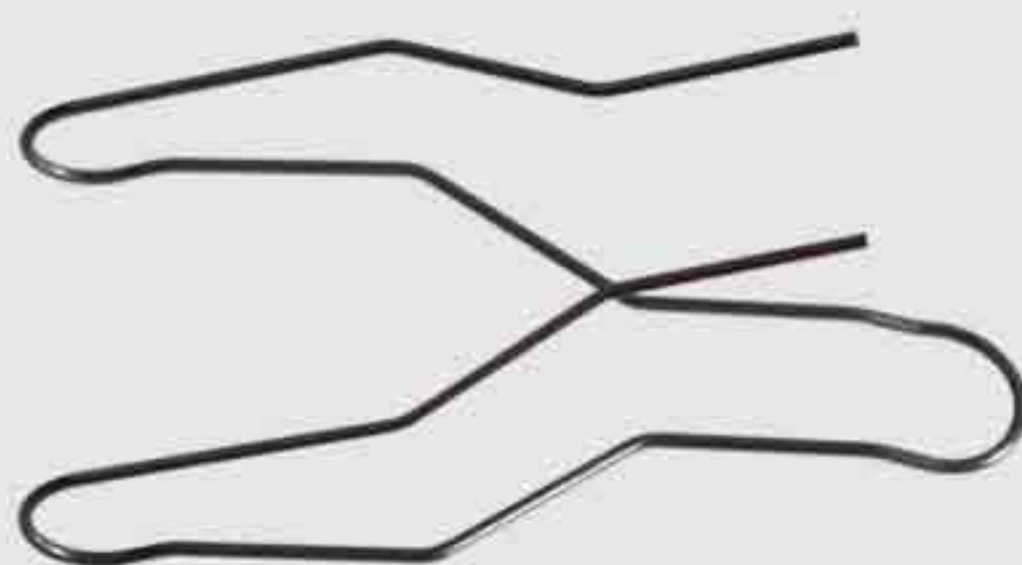
METABO / HITACHI

	Part #	Description	Nailer / Stapler Model #
	SP 949-518	Roll Pin D3 x 18	NR83A2/A2(S)/A3
	SP 877-339	Plunger (B)	NR83A / NR83AA2, NR83AA
	SP 887-727	Trigger Spring	NR83A2 / NR83A3 NR83A3S / NR83AA4
	SP 884-066	Handle Arm (B) (1 Hole)	NR83A
	SP 884-075	Guard Cover	NR83A2 / A2(S) / A3 / A3(S) / A5 / A5(S)
	SP 884-571	Handle Arm (B) (2 Hole)	NR83A
	SP 876-550	Sleeve	NR83A/A2/A2(S)

METABO / HITACHI

METABO HPT NR83A/A2/A3 STEEL MAGAZINE ASSEMBLIES

SP 884-065 Bare Magazine



SP 885-827
One (1)
Hole Assembly



SP 884-570
Two (2)
Hole Assembly

Part # Nailer / Stapler Model #

SP 884-065 NR83 + A2 + A2S

SP 884-570 NR83A (2 Hole Bracket)

SP 885-827 NR83A + A2 + A2S
(1 Hole Bracket)

Shoots up to 3-1/4" Long Nails

METABO/HITACHI SERVICE KITS

**DB83-01
METABO HPT NR83 SERVICE KIT**



S.No.	Part #	Description
1	SP 878-303	Aftermarket Piston Bumper
2	SP 877-323	Aftermarket Piston Driver

**DB83-01C
METABO HPT NR83 SERVICE KIT**



S.No.	Part #	Description
1	SP 878-303	Aftermarket Piston Bumper
2	SP 877-323C	Aftermarket Piston Driver (Japanese Carbide)

**DB83-02
METABO HPT NR83 SERVICE KIT**



S.No.	Part #	Description
1	SP 878-303G	Aftermarket Piston Bumper
2	SP 877-323	Aftermarket Piston Driver

**DB83-02C
METABO HPT NR83 SERVICE KIT**



S.No.	Part #	Description
1	SP 878-303G	Aftermarket Piston Bumper
2	SP 877-323C	Aftermarket Piston Driver (Japanese Carbide)



**ALL SERVICE KITS COMES IN A
RETAIL READY BLISTER PACK**

NR83 PARTS

METABO/HITACHI SERVICE KITS

**DBM83-01
METABO HPT NR83 SERVICE KIT**

S.No.	Part #	Description
1	SP 878-303	Aftermarket Piston Bumper
2	SP 877-323	Aftermarket Piston Driver
3	SP 885-827A	Aftermarket Aluminum Magazine

**DBM83-01C
METABO HPT NR83 SERVICE KIT**

S.No.	Part #	Description
1	SP 878-303	Aftermarket Piston Bumper
2	SP 877-323C	Aftermarket Piston Driver (Japanese Carbide)
3	SP 885-827A	Aftermarket Aluminum Magazine

**DBM83-02
METABO HPT NR83 SERVICE KIT**

S.No.	Part #	Description
1	SP 878-303	Aftermarket Piston Bumper
2	SP 877-323	Aftermarket Piston Driver
3	SP 885-827	Aftermarket Steel Magazine (1-Hole)

**DBM83-02C
METABO HPT NR83 SERVICE KIT**

S.No.	Part #	Description
1	SP 878-303	Aftermarket Piston Bumper
2	SP 877-323C	Aftermarket Piston Driver (Japanese Carbide)
3	SP 885-827	Aftermarket Steel Magazine (1-Hole)

NR83 PARTS

METABO/HITACHI SERVICE KITS

**DBM83-03
METABO HPT NR83 SERVICE KIT**

S.No.	Part #	Description
1	SP 878-303	Aftermarket Piston Bumper
2	SP 877-323	Aftermarket Piston Driver
3	SP 884-570	Aftermarket Steel Magazine (2-Holes)

**DBM83-03C
METABO HPT NR83 SERVICE KIT**

S.No.	Part #	Description
1	SP 878-303	Aftermarket Piston Bumper
2	SP 877-323C	Aftermarket Piston Driver (Japanese Carbide)
3	SP 884-570	Aftermarket Steel Magazine (2-Holes)

DBM83-04 - METABO HPT NR83 SERVICE KIT

S.No.	Part #	Description
1	SP 877-317	Aftermarket Cylinder Ring
2	SP 877-334	Aftermarket Gasket (A)
3	SP 877-325	Aftermarket Gasket (B)
4	SP 878-421	Aftermarket Ribbon Spring Set
5	SP 878-303	Aftermarket Piston Bumper
6	SP 877-323	Aftermarket Piston Driver

NR83 PARTS

METABO/HITACHI SERVICE KITS

DBM83-04C - METABO HPT NR83 SERVICE KIT



S.No.	Part #	Description
1	SP 877-317	Aftermarket Cylinder Ring
2	SP 877-334	Aftermarket Gasket (A)
3	SP 877-325	Aftermarket Gasket (B)
4	SP 878-421	Aftermarket Ribbon Spring Set
5	SP 878-303	Aftermarket Piston Bumper
6	SP 877-323C	Aftermarket Piston Driver (Japanese Carbide)

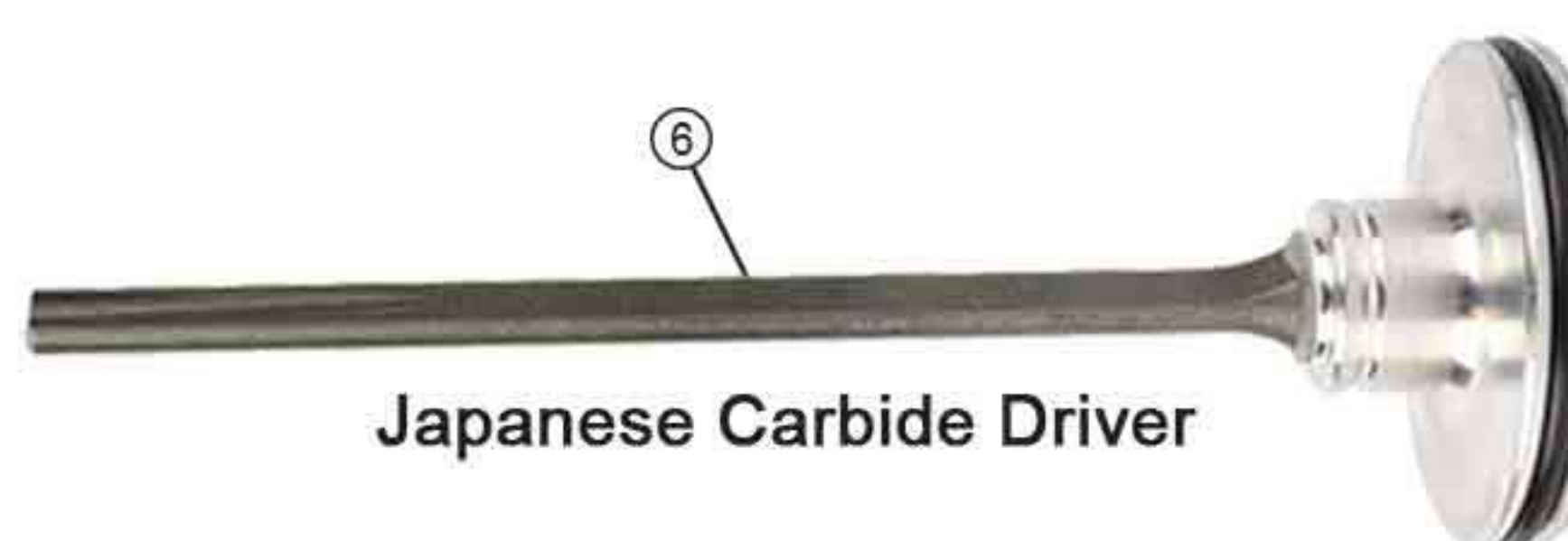

DBM83-04Q - METABO HPT NR83 SERVICE KIT



S.No.	Part #	Description
1	SP 877-317	Aftermarket Cylinder Ring
2	SP 877-334Q	Aftermarket Gasket (A) (Premium Gasket Material)
3	SP 877-325Q	Aftermarket Gasket (B) (Premium Gasket Material)
4	SP 878-421	Aftermarket Ribbon Spring Set
5	SP 878-303	Aftermarket Piston Bumper
6	SP 877-323	Aftermarket Piston Driver

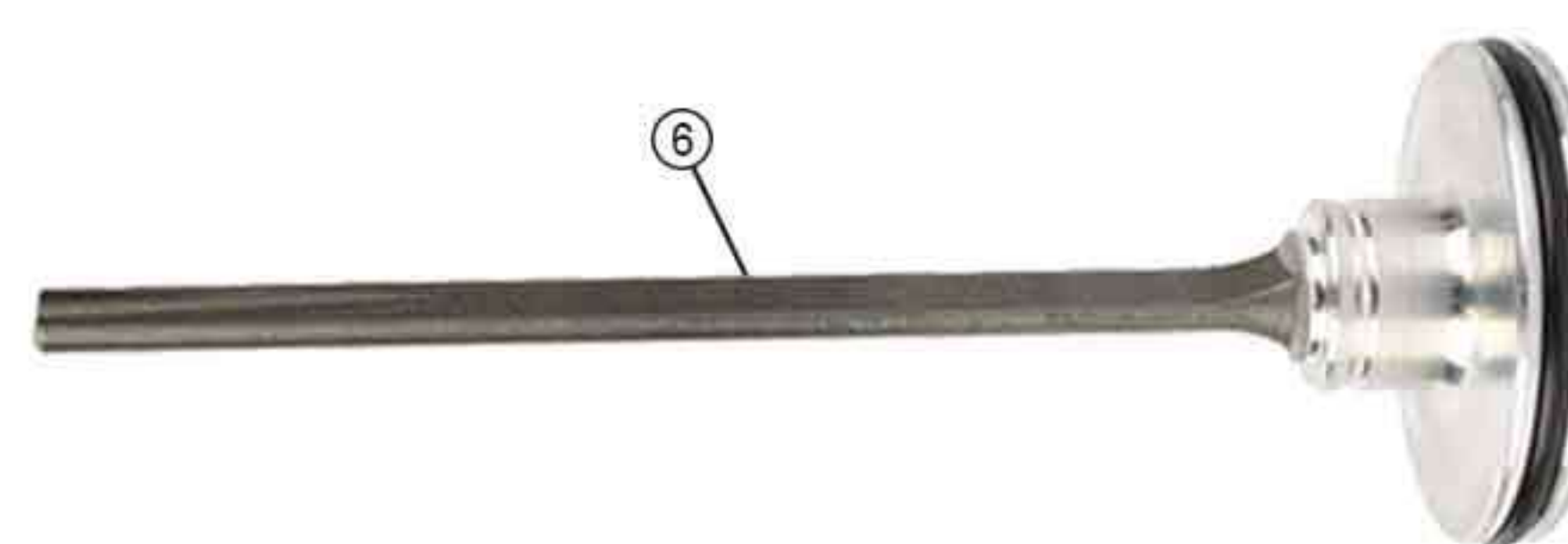

ALL SERVICE KITS COMES IN A RETAIL READY BLISTER PACK

METABO/HITACHI SERVICE KITS

DBM83-04CQ - METABO HPT NR83 SERVICE KIT



S.No.	Part #	Description
1	SP 877-317	Aftermarket Cylinder Ring
2	SP 877-334Q	Aftermarket Gasket (A) (Premium Gasket Material)
3	SP 877-325Q	Aftermarket Gasket (B) (Premium Gasket Material)
4	SP 878-421	Aftermarket Ribbon Spring Set
5	SP 878-303	Aftermarket Piston Bumper
6	SP 877-323C	Aftermarket Piston Driver Japanese Carbide

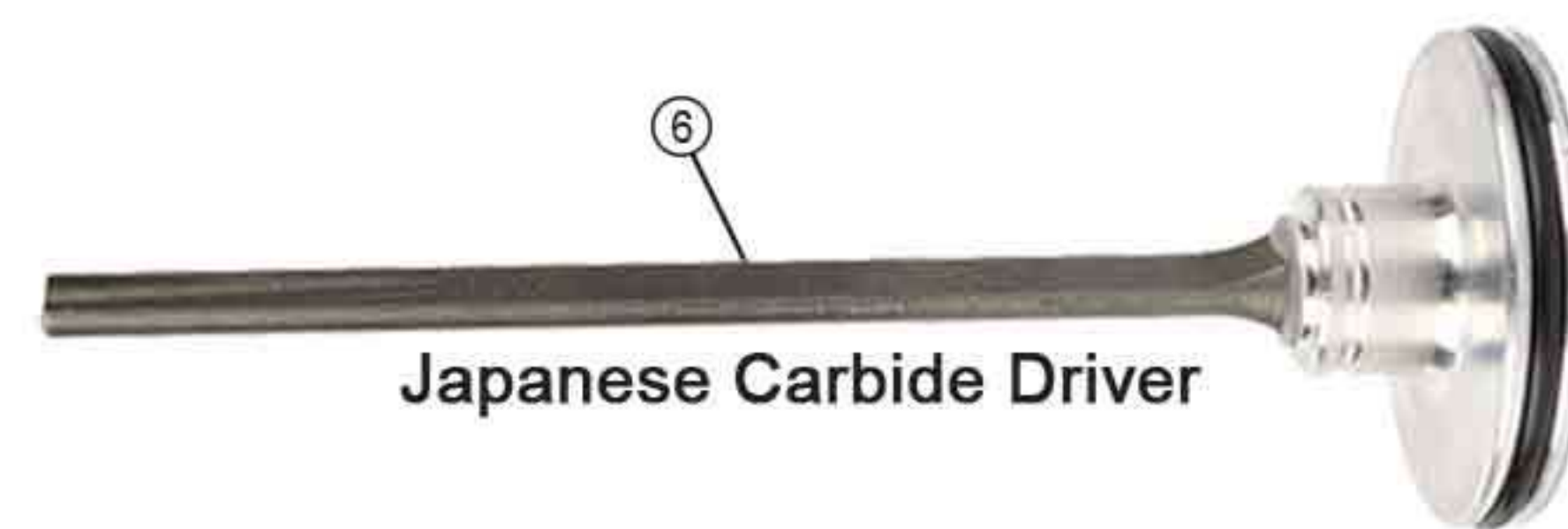

DBO65-01 - METABO HPT NT65M2 SERVICE KIT



S.No.	Part #	Description
1	SP 885-667	Aftermarket Piston Driver Assembly
2	SP 885-669	Aftermarket Piston Bumper
3	SP 873-093	Aftermarket O-Ring
4	SP 877-763	Aftermarket O-Ring
5	SP 878-888	Aftermarket O-Ring
6	SP 883-992	Aftermarket O-Ring
7	SP 885-666	Aftermarket Cylinder O-Ring
8	SP 885-668	Aftermarket Driver Piston O-Ring

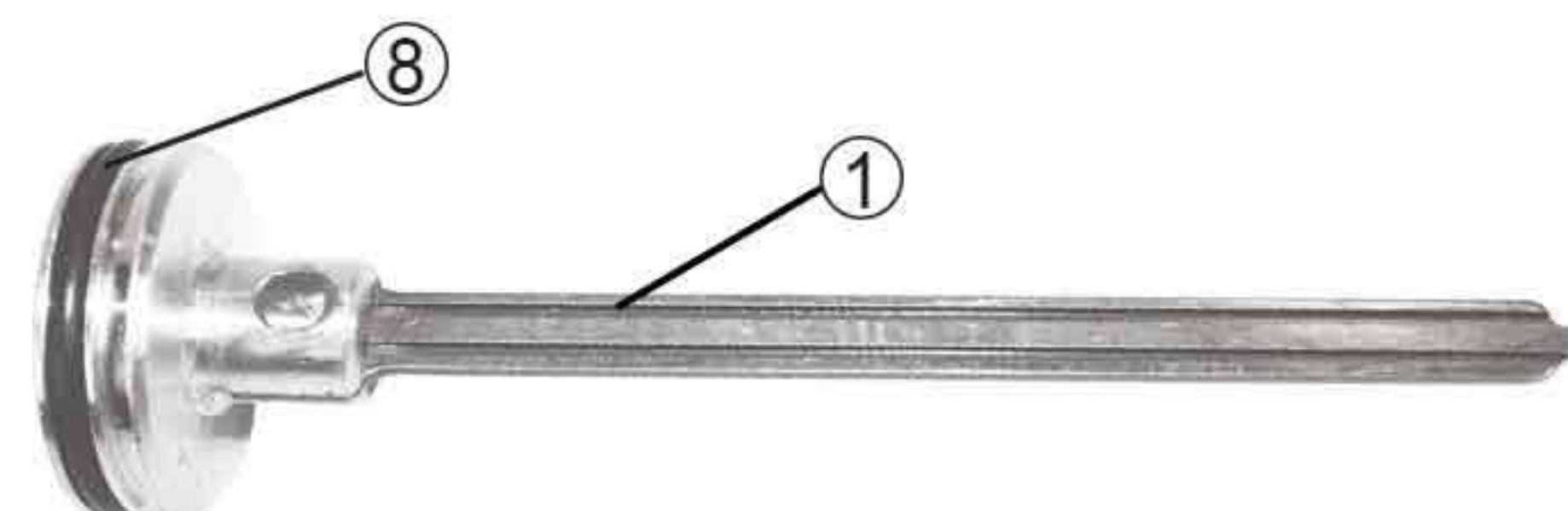

DB65V-01 - METABO HPT NV65AH SERVICE KIT

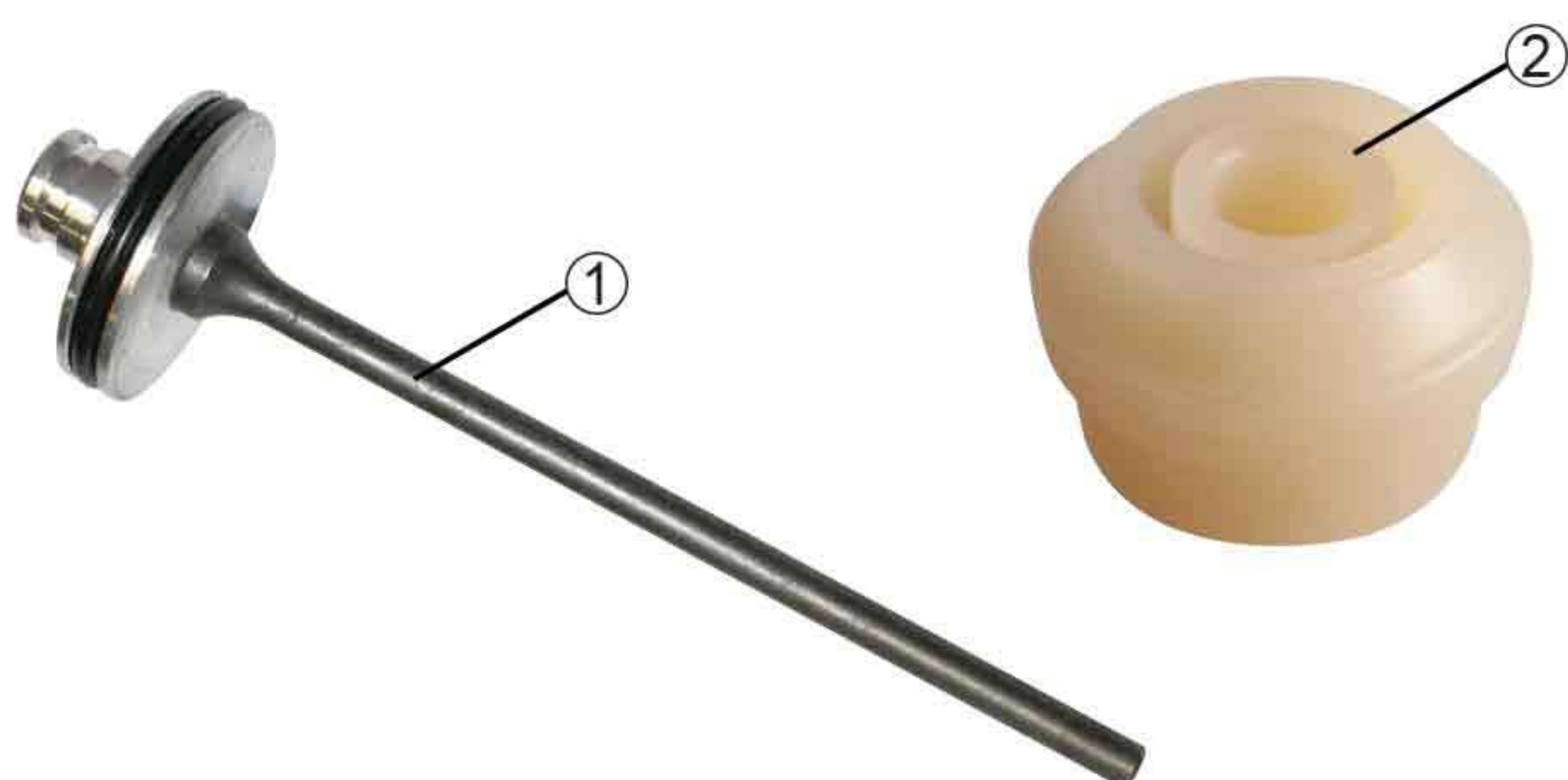





S.No.	Part #	Description
1	SP 882-684	Piston Driver Assembly
2	SP 882-676	Piston Bumper







ALL SERVICE KITS COMES IN A RETAIL READY BLISTER PACK

NR83 PARTS

METABO/HITACHI PISTON DRIVERS * Driver with UNI-LOK®

	Part #	Nailer / Stapler Model #
	SP 878-428*	NV83 + A2 + A3 + A14
	SP 878-428C*	NV83 + A2 + A3 + A14 (Japanese Carbide Driver)
	SP 888-160*	NV83A4
	SP 888-160C*	NV83A4 (Japanese Carbide Driver)

METABO/HITACHI PISTON BUMPERS

	Part #	Nailer / Stapler Model #
	SP 878-303	NV83A (Standard Ivory Color) - PU Material
	SP 878-303G	NV83A (Premium Green Color) - PU Material
	SP 878-303RED	NR83A, NR83A2, NR83A2(S) - 883-511, 878649, 877376 (German Material Red)
	SP 878-649	NV83A Short (B) - PU Material
	SP 877-711	NV83A/A2/A3

METABO/HITACHI O-RINGS



SP 874-436	SP 878-734	SP 877-368-OS
SP 874-820	SP 877-315	SP 877-368-OS-Q
SP 875-638	SP 878-863	SP 877-826
SP 877-312	SP 872-645	SP 878-376
SP 877-313	SP 872-821	
SP 877-314	SP 884-112	
SP 877-316	SP 877-368	
SP 877-327	SP 877-368Q	

METABO/HITACHI GASKETS & SETS

GASKETS & SET

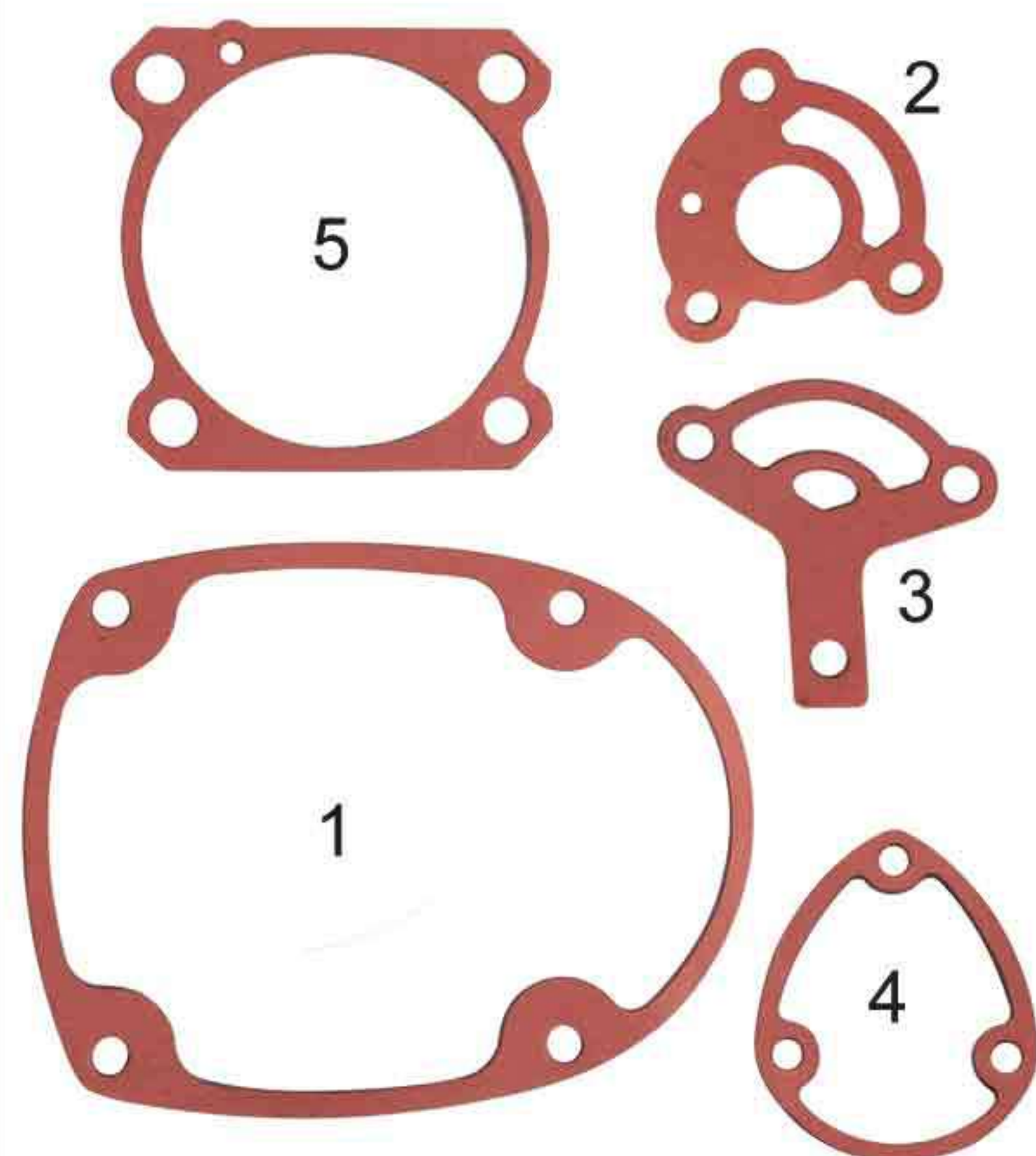

No.	Part #	Nailer / Stapler Model #	Type
1	SP 877-325	NV83A	B
2	SP 877-326*	NV83A	C
3	SP 877-329	NV83A	F
4	SP 877-331	NV83A	D
5	SP 877-334	NV83A2	A
	GS1	Gasket Set (includes all 5 of the above)	

* Interchangeable with 877-854

GASKETS & SET (PREMIUM QUALITY)

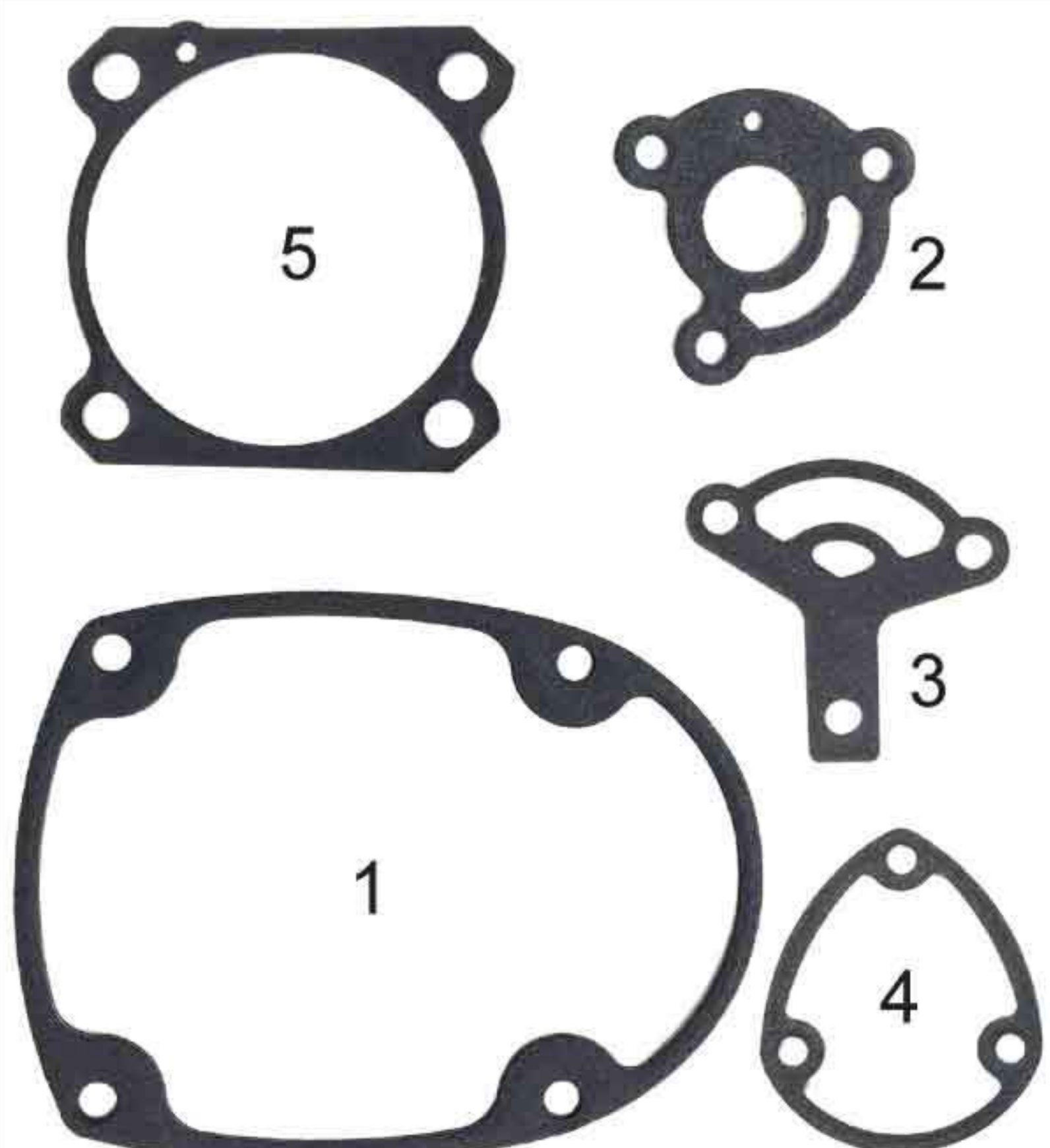

No.	Part #	Nailer / Stapler Model #	Type
1	SP 877-325Q	NV83A	B
2	SP 877-326Q*	NV83A	C
3	SP 877-329Q	NV83A	F
4	SP 877-331Q	NV83A	D
5	SP 877-334Q	NV83A2	A
	GS1Q	Gasket Set (includes all 5 of the above)	

- ▶ Stainless Steel Construction
- ▶ Rubber Coated
- ▶ Rigid Structure







* Interchangeable with 877-854











METABO/HITACHI NUTS / BOLTS / WASHERS

	Part #	Nailer / Stapler Model #	Type	Qty/Pk
	SP 877-322	Base Washer NV83A	-	1/Pk
	SP 880-081	Plain Washer NV83A	-	2/Pk
	SP 949-455	Spring Washer NV83A	M6	3/Pk
	SP 949-555	Nut NV83A/A2	M5	2/Pk
	SP 876-465	Nylon Nut NV83A	M4	5/Pk
	SP 877-371	Nut NV83A	M5	5/Pk











	Part #	Nailer / Stapler Model #	Type	Qty/Pk
	SP 883-492	Hex Bolt - Nose to Body NV83A2/A3	M8x20	4/Pk
	SP 949-650	Hex Socket HD Bolt NV83A	M4x15	5/Pk
	SP 949-652	Hex Bolt - Head Cap to body NV83A	M6x25	4/Pk
	SP 949-655	Hex Bolt - Magazine (1 hole) Handle Arm to Body NV83A	M8x16	5/Pk
	SP 949-657	Hex Socket HD Bolt NV83A	M6x12	5/Pk
	SP 949-658	Hex Bolt - Air Inlet Cap to Handle NV83A	M5x18	3/Pk
	SP 949-757	Hex Bolt - Air Inlet Cap to Body NV83A	M5x20	5/Pk
	SP 949-832	Hex Bolt - Top Cover to Head NV83A	M6x45	3/Pk
	SP 878-614	Nylock Hex Socket HD Bolt NV83A	M4x8	1/Pk
	SP 949-230	Machine Screw NV83A	M4x50	10/Pk

METABO/HITACHI SPRINGS / PINS / SHAFTS

	Part #	Description	Nailer / Stapler Model #
	SP 884-025	Roll Pin D3X45 1/pk	NV83A
	SP 949-866	Roll Pin D3X30 10/pk	NV83A
	SP 887-852	Roll Pin D3 x 45 1/pk	NV83A
	SP 949-776	Roll Pin D3 x 10 10/pk	NV83A
	SP 877-820	Lock Shaft	NV83A/A2
	SP 877-825	Feeder Shaft	NV83A/A2/A3

	Part #	Description	Nailer / Stapler Model #
	SP 875-643	Plunger Spring (Top)	NV83A/A2
	SP 877-321	Cylinder Spring for Sealing Ring	NV83A/A2
	SP 887-724	Plunger Spring	NV83A2/A3/A(S)
	SP 884-067	Compression Spring	NV83A3
	SP 877-365	Compression Spring	NV83A2
	SP 877-468	Compression Spring	NV83A2/A2/A3
	SP 876-681	Main Stopper Spring	NV83A/A2/A3
	SP 877-372	Spring	NV83A/A2/A3
	SP 877-851	Feeder Spring	NV83A/A2
	SP 880-175	Spring	NV83A3/A53

METABO / HITACHI AFTERMARKET PARTS

	Part #	Description	Nailer / Stapler Model #
	SP 889-087	Cylinder Guide	NV83A5
	SP 877-310	Lower Cylinder Guide	NV83A/A2
	SP 877-318	Support Collar (Upper)	NV83A/A2
	SP 875-645R	Rubber Ball	NV83A/A2
	SP 959-148	Steel Ball For Depth Adjuster	NV83A
	SP 877-852	Head Cap - Gasket Set	NV83A/A2
	SP 877-330	Top Cover	NV83A/A2/A3
	SP 878-121	Trigger Plunger	NV83A/A2
	SP 875-642	Safety Plunger (B)	NV83A2
	SP 875-644 Replaces (887-777)	Trigger Valve Plate	NR83A/A2, NV83A/A2
	SP 877-335	Trigger Valve Bushing	NR83A/A2, NV83A/A2

METABO / HITACHI AFTERMARKET PARTS

	Part #	Description	Nailer / Stapler Model #
	SP 887-773 Replaces (883-506)	Tool Body	NV83A4
	SP 878-311	Air Inlet Cap	NV83A/A2/A3
	SP 887-774	Exhaust Valve	NV83A3
	SP 888-132	Cylinder Guide Ring	NV83A3
	SP 888-133	Cylinder	NV83A3
	SP 884-068 Replaces (877-810)	Cylinder	NV83A/A2/A2(S)
	SP 884-038	Holder Cap	NV83A2/A3/A4/A5
	SP 884-037	Ratchet Spring	NV83A2/A3/A4/A5M

METABO / HITACHI AFTERMARKET PARTS

	Part #	Description	Nailer / Stapler Model #
	SP 877-713	Feed Piston Cover	NV83A/A2/A3/A4/A5
	SP 877-856	Nail Feeder Set	NV83A/A2
	SP 877-317	Cylinder Ring	NV83A/A2/A23/A3
	SP 877-469	Nail Guide Cover	NV83A/A2/A83/A3
	SP 877-821	Guide Lock	NV83A/A2
	SP 888-153	Nose	NV83A4

METABO/HITACHI SERVICE KITS

DBM83V-04 - METABO HPT NR83A/A2 SERVICE KIT



S.No.	Part #	Description
1	SP 877-825	Aftermarket Feeder Shaft
2	SP 877-826	Aftermarket Shaft O-Ring
3	SP 877-334	Aftermarket Gasket (A)
4	SP 877-325	Aftermarket Gasket (B)
5	SP 877-851	Aftermarket Feeder Spring
6	SP 878-303/ SP 883-511	Aftermarket Piston Bumper
7	SP 878-428	Aftermarket Piston Driver

DBM83V-04C - METABO HPT NR83A/A2 SERVICE KIT



S.No.	Part #	Description
1	SP 877-825	Aftermarket Feeder Shaft
2	SP 877-826	Aftermarket Shaft O-Ring
3	SP 877-334	Aftermarket Gasket (A)
4	SP 877-325	Aftermarket Gasket (B)
5	SP 877-851	Aftermarket Feeder Spring
6	SP 878-303/ SP 883-511	Aftermarket Piston Bumper
7	SP 878-428C	Aftermarket Piston Driver (Japanese Carbide)

METABO/HITACHI SERVICE KITS

DBM83V-04CQ - METABO HPT NR83A/A2 SERVICE KIT



S.No.	Part #	Description
1	SP 877-825	Aftermarket Feeder Shaft
2	SP 877-826	Aftermarket Shaft O-Ring
3	SP 877-334Q	Aftermarket Gasket (A) (Premium Gasket Material)
4	SP 877-325Q	Aftermarket Gasket (B) (Premium Gasket Material)
5	SP 877-851	Aftermarket Feeder Spring
6	SP 878-303/ SP 883-511	Aftermarket Piston Bumper
7	SP 878-428C	Aftermarket Piston Driver (Japanese Carbide)





ALL SERVICE KITS COMES IN A RETAIL READY BLISTER PACK

METABO / HITACHI PISTON DRIVER

	Part #	Nailer / Stapler Model #
	SP 878-156	NV45AB/AB2/AB2(S)

METABO / HITACHI PISTON BUMPERS

	Part #	Nailer / Stapler Model #
	SP 877-993	NV45AB2/AB2(S)/AB/AA - PU Material
	SP 878-179	NV45AB2/AB2(S)/AE/AB - PU Material

METABO / HITACHI O-RINGS

	SP 884-112	SP 877-123	SP 877-826
	SP 872-645	SP 877-124	
	SP 872-821	SP 877-125	
	SP 874-820	SP 877-126	
	SP 875-638	SP 877-763	
	SP 876-161	SP 877-764	
	SP 876-167	SP 878-734	
	SP 876-174	SP 885-793	

METABO/HITACHI O-RING KIT



METABO HPT O-RINGS & KIT		
Part #	Nailer / Stapler Model #	Qty/Pk
SP 872-645	NV45	1/pk
SP 872-821	NV45	1/pk
SP 876-161	NV45	3/pk
SP 876-167	NV45	1/pk
SP 877-123	NV45	1/pk
SP 877-124	NV45	1/pk
SP 877-125	NV45	1/pk
SP 877-126	NV45	1/pk
SP 877-763	NV45	1/pk
SP 877-764	NV45	1/pk
SP 884-112	NV45	2/pk
SP 885-793	NV45	3/pk
SP 874-820	NV45	2/pk
SP 875-638	NV45	1/pk
SP 876-174	NV45	1/pk
SP 878-734	NV45	1/pk
G845	O-Ring Kit - Includes all (16) of the above O-Rings	22/pk



G845
Metabo HPT NV45

NV45 PARTS

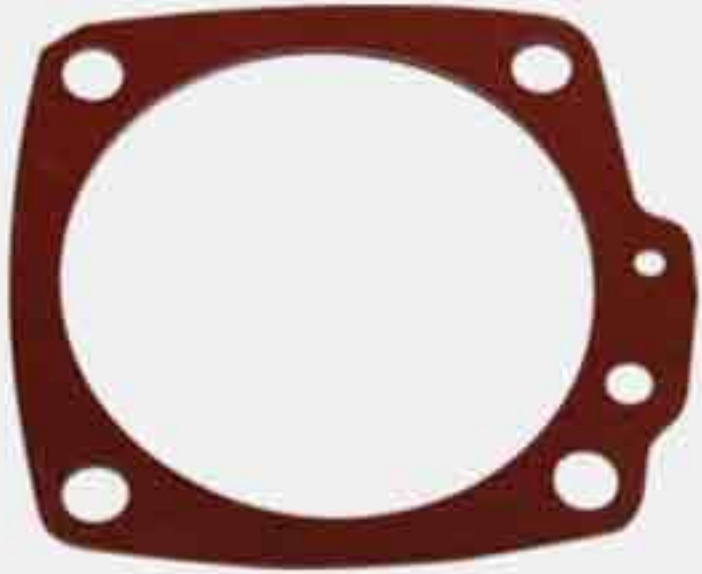
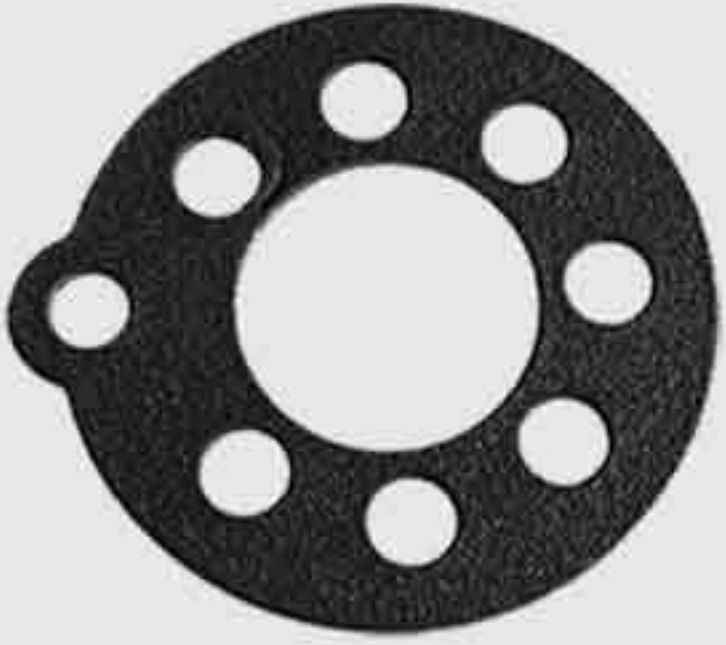
METABO/HITACHI GASKETS

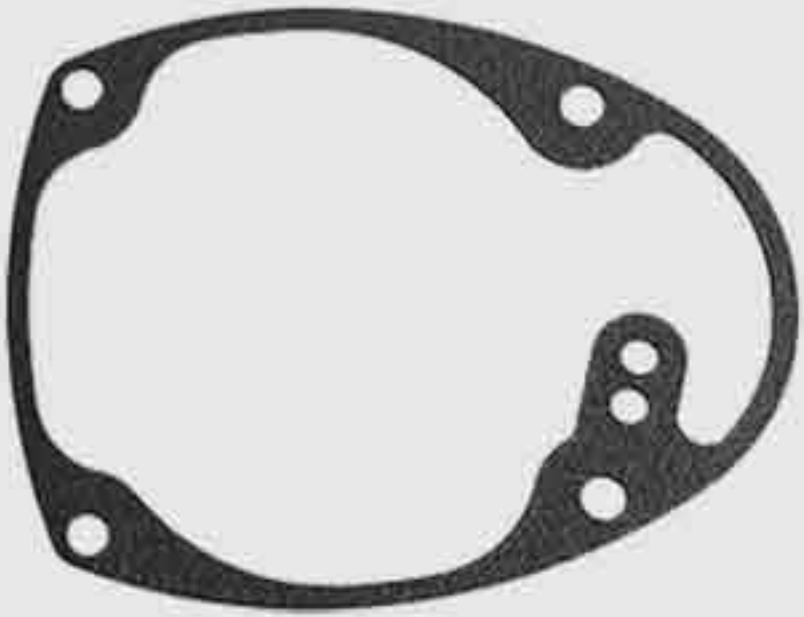
	Part #	Nailer / Stapler Model #
	SP 883-881	Gasket(A) NV45AB2/AB2(S)/AE
	SP 876-713Q Premium Quality	Gasket(G) NV45AB/AB2/AB2(S)/AE
	SP 877-131Q Premium Quality	Gasket(D) NV45AB/AB2/AE
	SP 883-892Q Premium Quality	Gasket(F) NV45AB/AB2/AB2(S)

METABO/HITACHI NUTS / BOLTS



	Part #	Nailer / Stapler Model #	Type	Qty/Pk
	SP 876-465	Nylon Nut NV45AB/AB2/AB2(S)	M4	5/Pk
	SP 949-555	Nut NV45AB2	M5	2/Pk
	SP 949-662	Hex Bolt - Magazine (2 hole) Handle Arm to Body NV45AB	M5x25	5/Pk
	SP 949-757	Hex Bolt - Air Inlet Cap to Body NV45AB2	M5x20	5/Pk
	SP 875-650	Hex Bolt NV45AB2	M5x16	1/Pk
	SP 958-805	Bolt NV45AB/B2/B2(S)	xx	10/Pk
	SP 878-181	Hex Socket HD Bolt NV45AB2	M5x16	1/Pk
	SP 949-230	Machine Screw NV45A	M4x50	10/Pk
	SP949-424	Plain Washer NV45AB, NV45AE	M5	10/Pk

METABO/HITACHI SPRINGS / PINS / SHAFTS

	Part #	Description	Nailer / Stapler Model #
	SP 877-825	Feeder Shaft	NV45AB/AB2/AB2(S)
	SP 877-820	Lock Shaft	NV45AB/B2
	SP 878-171	Plunger (B)	NV45AB/AB2/AB2(S)/AE
	SP 883-884	Nail Guide Shaft	NV45AB2/AB2(S)/AE
	SP 949-866	Roll Pin D3X30 (10/pk)	NV45AB/AB2AB2(S)
	SP 949-776	Roll Pin (10/pk)	NV45AB/AB2/AB2(S)
	SP 878-121	Trigger Plunger	NV45AB/AB2/AB2(S)/AE
	SP 878-170	Valve Rubber Cover	NV45AB/AB2/AB2(S)/AE
	SP 883-885	Shaft Ring	NV45AB2/AB2(S)/AE
	SP 883-891	Protector (3/pk)	NV45AB

NV45 PARTS

METABO / HITACHI SPRINGS / PINS / SHAFTS







	Part #	Description	Nailer / Stapler Model #
	SP 876-681	Main Stopper Spring	NV45AB/AB2/AB2(S)/AE
	SP 877-761	Feeder Spring	NV45AB/AB2/AB2(S)/AE
	SP 876-172	Cylinder Spring	NV45AB/AB2/AB2(S)/AE
	SP 880-398	Ratchet Spring	NV45AB2/AB2(S)/AE
	SP 877-468	Compression Spring	NV45AB/AB2/AB2(S)
	SP 875-643	Plunger Spring (Top)	NV45AB/AB2/AB2(S)
	SP 877-372	Spring	NV45AB/AB2/AB(S)
	SP 883-883	Adjuster Spring	NV45AE/AB2/AB2(S)
	SP 878-178	Compression Spring	NV45AB/AB2/AB2(S)/AE
	SP 883-111	Pin	NV45AB/AB2/AB2(S)/AE
	GS845	Feeder Assmebly	NV45AB/AB2/AB2(S)

NV45 PARTS

METABO / HITACHI SPRINGS / PINS / SHAFTS

	Part #	Description	Nailer / Stapler Model #
	SP 876-174-KIT	SP 876-174 Piston O-Ring -10/Pk SP 877-761 Feeder Spring - 10/Pk	NV45AB2/AB2(S)

METABO / HITACHI AFTERMARKET PARTS

	Part #	Description	Nailer / Stapler Model #
	NV45NOSE-K Replaces Metabo HPT 883-880	Nose Kit	NV45AB2/AB2(S)
	SP 883-880M Modified Nose		
	SP 883-887M Modified Nail Guide		
	SP 883-901M Modified Feeder		
	SP 878-173	Nose Guard	NV45AB/AB2/AB2(S)/AE
	SP 883-888	Pushing Lever	NV45AB/AB2/AB2(S)/AE
	SP 878-152	Feed Piston	NV45AB/AB2/AB2(S)/AE

* Three separate pieces make up the kit, and only interchange with each other. Cannot mix-n-match these parts with OEM Nose, Nail Guide or Feeder.

This kit gives the option and affordability, to keep your coil nailer up and running, in great working order and, when the kit is used on an NV45AB2, other OEM parts can then be installed.

METABO/HITACHI AFTERMARKET PARTS

	Part #	Description	Nailer / Stapler Model #
	SP 877-821	Guide Lock	NV45AB/AB2/AB2(S)
	SP 878-185	Main Nail Stopper	NV45AB/ AB2/AB2(S)
	SP 883-895	Magazine	NV45AB2/AB2(S)/AE
	SP 883-896	Nail Holder	NV45AB2/AB2(S)/AE
	SP 883-899	Magazine Cover	NV45AB2/AB2(S)
	SP 877-469	Nail Guide Cover	NV45AB/AB2/AB2(S)
	SP 883-897	Holder Shaft	NV45AB2/AB2(S)/AE
	SP 878-186	Nail Stopper	NV45AB/AB2/AB2(S)
	SP 878-175	Shingle Guide	NV45AB/AB2/AB2(S)/AE

NV45 PARTS

METABO/HITACHI AFTERMARKET PARTS

NV45 PARTS

	Part #	Description	Nailer / Stapler Model #
	SP 883-898	Magazine Guard	NV45AB2/AB2(S)
	SP 883-900	Holder Cap	NV45AB2/AB2(S)/AE
	SP 878-213	Plate Nut	NV45AB/AB2/AB2(S)/AE
	SP 877-479	Magazine Bushing	NV45AB/AB2/AB2(S)/AE
	SP 878-151	Guard	NV45AB/AB2/AB2(S)
	SP 877-122	Cylinder Guide	NV45AB/AB2/AB2(S)
	SP 877-486	Cylinder	NV45AB/AB2/AB2(S)/AE
	SP 876-168	Cylinder Plate	NV45AB/AB2/AB2(S)

METABO / HITACHI AFTERMARKET PARTS

	Part #	Description	Nailer / Stapler Model #
	SP 883-882	Adjuster	NV45AB/AB2/AB2(S)/AE
	SP 876-179	Top Cover	NV45AB/AB2/AB2(S)
	SP 876-711	Head Cap	NV45AB/AB2/AB2(S)/AE
	SP 875-644 Replaces (887-777)	Trigger Valve Plate	NV45AB/AB2/AB2(S)
	SP 875-645R	Rubber Ball	NV45AB/AB2/AB2(S)
	SP 877-335	Trigger Valve Bushing	NV45AB/AB2/AB2(S)
	SP 876-203	Trigger Lever	NV45AB/AB2/AB2(S)

NV45 PARTS

METABO/HITACHI SERVICE KITS

DB45V-01 - METABO HPT NV45AB SERVICE KIT



S.No.	Part #	Description
1	SP 878-156	Aftermarket Piston Driver
2	SP 878-179	Aftermarket Piston Bumper

DB45V-02 - METABO HPT NV45AB SERVICE KIT



S.No.	Part #	Description
1	SP 878-156	Aftermarket Piston Driver
2	SP 878-179	Aftermarket Piston Bumper
3	SP 877-993	Aftermarket PU Guide Sheet

DB45V-03 - METABO HPT NV45AB SERVICE KIT



S.No.	Part #	Description
1	SP 878-156	Aftermarket Piston Driver
2	SP 878-179	Aftermarket Piston Bumper
3	SP 877-993	Aftermarket PU Guide Sheet
4	SP 883-892Q	Aftermarket Gasket (Premium Gasket Material)
5	SP 877-761	Aftermarket Feeder Spring
6	SP 877-826	Aftermarket Feeder Shaft Rings (5Pcs/Pack)
7	SP 878-178	Aftermarket Pushing Lever Spring





ALL SERVICE KITS COMES IN A RETAIL READY BLISTER PACK

METABO / HITACHI PISTON DRIVER

	Part #	Nailer / Stapler Model #
	SP 883-716	N5008AC/AC2/ACP

METABO / HITACHI PISTON BUMPERS

	Part #	Nailer / Stapler Model #
	SP 883-711	N5008AC
	SP 886-434	N5008AC2, N5008AC2M

METABO / HITACHI O-RINGS

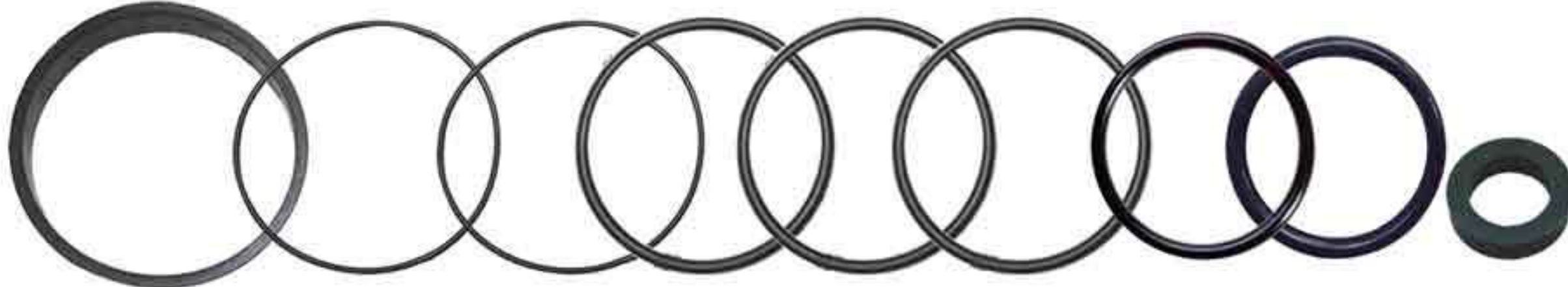
	SP 876-174	SP 877-125
	SP 876-161	SP 877-123
	SP 877-126	SP 875-638
	SP 876-167	SP 878-734
	SP 877-124	SP 874-820

METABO HPT O-RINGS & KIT

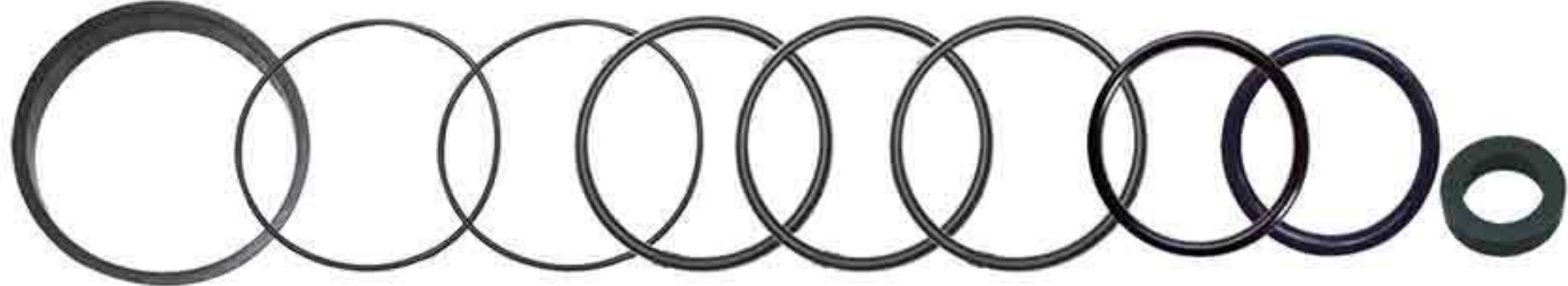



	Part #	Nailer / Stapler Model #	Qty/Pk
	SP 876-174	N5008AC/AC2/ACP	2/pk
	SP 876-161	N5008AC/AC2/ACP	2/pk
	SP 877-126	N5008AC/AC2/ACP	2/pk
	SP 876-167	N5008AC/AC2/ACP	2/pk
	SP 877-124	N5008AC/AC2/ACP	2/pk
	SP 877-125	N5008AC/AC2/ACP	2/pk
	SP 877-123	N5008AC/AC2/ACP	2/pk
	SP 875-638	N5008AC/AC2/ACP	2/pk
	SP 878-734	N5008AC/AC2/ACP	2/pk
	SP 874-820	N5008AC/AC2/ACP	2/pk
	G508	O-Ring kit includes all above O-Rings	20/pk

N5008AC PARTS





METABO / HITACHI GASKETS

	Part #	Nailer / Stapler Model #
	SP 876-178	Gasket(C) N5008AC / AC2 / ACP
	SP 877-131Q Premium Quality	Gasket(B) N5008AC / AC2 / ACP

METABO / HITACHI NUTS / BOLTS









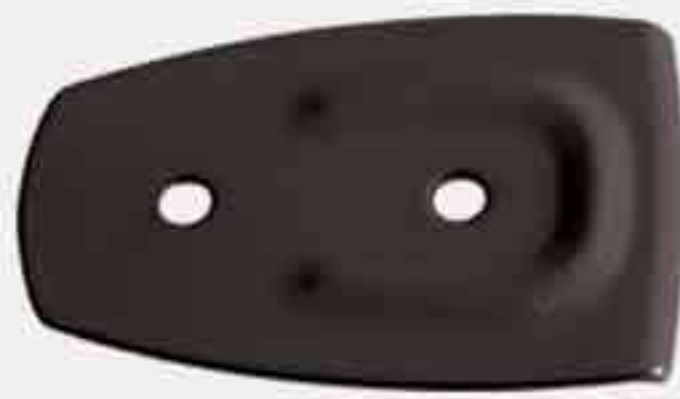

	Part #	Nailer / Stapler Model #	Type	Qty/Pk
	SP 877-371	Nylon Nut N5008AC / AC2 / ACP	M4	5/Pk
	SP 949-555	Nut N5008AC / AC2 / ACP	M5	10/Pk
	SP 949-757	Hex Socket HD Bolt N5008AC / AC2 / ACP	M5x20	5/Pk
	SP 875-650	Hex Bolt N5008AC / AC2 / ACP	M5x16	5/Pk

METABO / HITACHI SPRINGS / PINS / SHAFTS

	Part #	Description	Nailer / Stapler Model #
	SP 876-174-KIT	SP 876-174 Piston O-Ring -10/Pk SP 877-761 Feeder Spring - 10/Pk	N5008AC / AC2 / ACP
	SP 876-172	Cylinder Spring	N5008AC / AC2 / ACP
	SP 875-643	Plunger Spring (Top)	N5008AC / AC2 / ACP
	SP 949-866	Roll Pin (10/pk)	N5008AC / AC2 / ACP

N5008AC PARTS

METABO / HITACHI AFTERMARKET PARTS

	Part #	Description	Nailer / Stapler Model #
	SP 883-712	Bumper Sheet	N5008AC
	SP 889-503	Ribbon Spring	N5008AC / AC2 / ACP
	SP 876-179	Top Cover	N5008AC / AC2 / ACP
	SP 877-122	Cylinder Guide	N5008AC / AC2 / ACP
	SP 876-168	Cylinder Plate	N5008AC / AC2 / ACP
	SP 878-121	Trigger Plunger	N5008AC / AC2 / ACP
	SP 876-203	Trigger Lever	N5008AC / AC2 / ACP
	SP 878-539	Exhaust Valve	N5008AC / AC2 / ACP
	SP 875-645R	Rubber Ball	N5008AC / AC2 / ACP
	SP 875-644 Replaces (887-777)	Trigger Valve Plate	N5008AC / AC2 / ACP
	SP 877-335	Trigger Valve Bushing	N5008AC / AC2 / ACP

N5008AC PARTS

METABO/HITACHI PISTON DRIVER

	Part #	Nailer / Stapler Model #
	SP 886-437	N5010A

METABO/HITACHI PISTON BUMPERS

	Part #	Nailer / Stapler Model #
	SP 886-434	N5010A

METABO/HITACHI GASKETS







	Part #	Nailer / Stapler Model #
	SP 876-178	Gasket(C) N5010A
	SP 877-131Q Premium Quality	Gasket(B) N5010A
	SP 883-892Q Premium Quality	Gasket(F) N5010A

METABO/HITACHI O-RINGS





	SP 876-174	SP 876-167	SP 875-638
	SP 885-793	SP 877-124	SP 878-734
	SP 876-161	SP 877-125	SP 888-151
	SP 877-126	SP 877-123	SP 874-820

N5010A PARTS

METABO/HITACHI NUTS / BOLTS







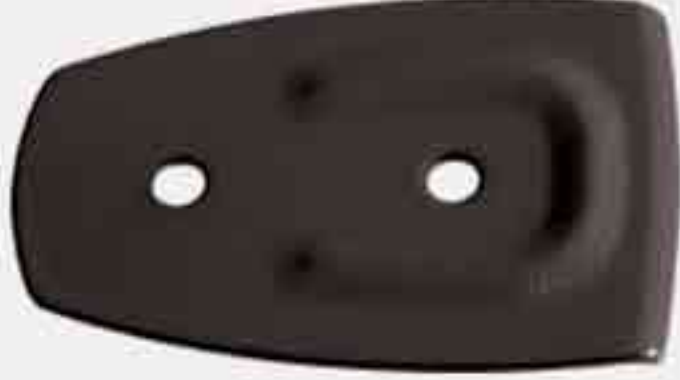

	Part #	Nailer / Stapler Model #	Type	Qty/Pk
	SP 877-371	Nylon Nut N5010A	M4	5/Pk
	SP 949-555	Nut N5010A	M5	10/Pk
	SP 949-757	Hex Socket HD Bolt N5010A	M5x20	5/Pk
	SP 875-650	Hex Bolt N5010A	M5x16	5/Pk
	SP 949-658	Hex Socket HD Bolt N5010A	M5x18	3/Pk
	SP 878-181	Hex Socket HD Bolt N5010A	M5x16	1/Pk

METABO/HITACHI SPRINGS / PINS / SHAFTS

	Part #	Description	Nailer / Stapler Model #
	SP 876-174-KIT	SP 876-174 Piston O-Ring -10/Pk SP 877-761 Feeder Spring - 10/Pk	N5010A
	SP 876-172	Cylinder Spring	N5010A
	SP 875-643	Plunger Spring (Top)	N5010A
	SP 949-866	Roll Pin (10/pk)	N5010A
	SP 884-025	Spring Pin D3x45	N5010A



N5010A PARTS

METABO/HITACHI AFTERMARKET PARTS

	Part #	Description	Nailer / Stapler Model #
	SP 889-503	Ribbon Spring	N5008AC / AC2 / ACP
	SP 876-179	Top Cover	N5008AC / AC2 / ACP
	SP 877-122	Cylinder Guide	N5008AC / AC2 / ACP
	SP 876-168	Cylinder Plate	N5008AC / AC2 / ACP
	SP 878-121	Trigger Plunger	N5008AC / AC2 / ACP
	SP 876-203	Trigger Lever	N5008AC / AC2 / ACP
	SP 878-539	Exhaust Valve	N5008AC / AC2 / ACP
	SP 875-645R	Rubber Ball	N5008AC / AC2 / ACP
	SP 875-644 Replaces (887-777)	Trigger Valve Plate	N5008AC / AC2 / ACP
	SP 877-335	Trigger Valve Bushing	N5008AC / AC2 / ACP

N5010A PARTS

METABO / HITACHI PISTON DRIVER

	Part #	Nailer / Stapler Model #
	SP 883-471	NR65AK / AK(S) / AK2
	SP 883-471C	NR65AK / AK(S) / AK2 (Japanese Carbide Driver)

METABO / HITACHI PISTON BUMPER

	Part #	Nailer / Stapler Model #
	SP 883-432	NR65AK / AK(S) / AK2







METABO / HITACHI GASKETS

	Part #	Nailer / Stapler Model #
	SP 883-452Q Premium Quality	Gasket(B) NR65AK2 / AK2(S)



METABO / HITACHI O-RINGS

	SP 883-992	SP 878-925
	SP 878-863	SP 878-887
	SP 877-368	SP 981-317
	SP 877-368Q	SP 878-888
	SP 883-431	SP 873-093
	SP 874-436	
	SP 877-699	
	SP 878-885	

METABO / HITACHI NUTS / BOLTS / WASHERS

	Part #	Nailer / Stapler Model #	Type	Qty/Pk
	SP 877-371	Nylon Nut NR65AK2	M4	5/Pk
	SP 963-837	Nylon Nut NR65AK2	M6	5/Pk
	SP 949-424	Plunger Metal Washer NR65AK2	M5	5/Pk
	SP 949-454	Spring Washer NR65AK2	M6	3/Pk
	SP 949-657	Hex Socket HD Bolt NR65AK2	M6x10	5/Pk
	SP 878-647	Hex Socket HD Bolt NR65AK	M6x12	5/Pk
	SP 880-675	High Tension Bolt NR65AK2	M6x20	4/Pk

METABO / HITACHI SPRINGS / PINS / SHAFTS

	Part #	Description	Nailer / Stapler Model #
	SP 883-470	Compression Spring	NR65AK / AK(S) / AK2
	SP 949-535	Roll Pin D3x12 (10/pk)	NR65AK / AK(S) / AK2

METABO / HITACHI AFTERMARKET PARTS

	Part #	Description	Nailer / Stapler Model #
	SP 883-440	Ribbon Spring	NR65AK / AK(S) / AK2
	SP 883-989	Cylinder	NR65AK / AK(S) / AK2
	SP 882-927	Head Valve (A)	NR65AK / AK(S) / AK2

NR65AK2 PARTS

METABO / HITACHI PISTON DRIVER

	Part #	Nailer / Stapler Model #
	SP 885-918*	NR90AE + AE(S) (Replaces 885-519 & 887-491)

METABO / HITACHI PISTON BUMPERS

	Part #	Nailer / Stapler Model #
	SP 884-959	NR90AE

METABO / HITACHI AFTERMARKET PARTS

	Part #	Description	Nailer / Stapler Model #
	SP MAG90-2	Nailer Feeder (B) Plastic Slide	NR90AE
	SP MAG90-3	Roll Pin with O-Ring	NR90AE
	SP MAG90-4	Feeder Spring	NR90AE
	SP 884-958	Piston O-Ring	NR90AE
	SP 877-317	Cylinder Ring	NR90AE
	SP 883-503 SP 943-364	Trigger Lever	NR90AE

METABO / HITACHI PISTON DRIVER

	Part #	Nailer / Stapler Model #
	SP 885-870	NT50A5 + NT50A5M + NT50AE2 + AE2(S)
	SP 882-340	NT50AE + AE(S) (Replaces 882-283)

METABO / HITACHI PISTON BUMPER

	Part #	Nailer / Stapler Model #
	SP 882-287	NT50AE, NT50AES - Rubber Material







METABO / HITACHI GASKETS

	Part #	Nailer / Stapler Model #
	SP 877-131Q Premium Quality	Gasket(D) NT50A
	SP 876-178	Gasket(C) NT50A





METABO / HITACHI O-RINGS

	SP 872-821	SP 876-126	SP 877-124
	SP 874-820	SP 876-161	SP 877-125
	SP 875-638	SP 876-167	SP 882-282
	SP 876-174	SP 877-123	

METABO / HITACHI NUTS / BOLTS / WASHERS

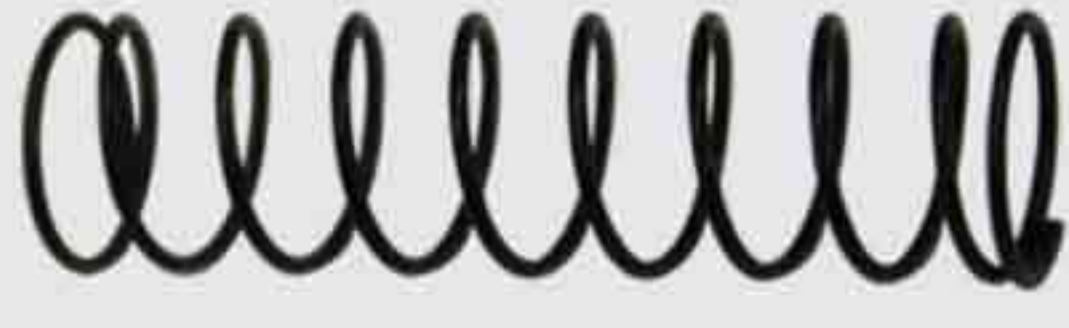
	Part #	Nailer / Stapler Model #	Type	Qty/Pk
	SP 877-371	Nylon Nut NT50A	M4	5/Pk
	SP 876-465	Nylon Nut NT50AE	M4	5/Pk
	SP 949-555	Nut NT50AE	M5	2/Pk
	SP 949-454	Spring Washer NT50A	M6	3/Pk
	SP 949-662	Hex Bolt - Magazine (2 hole) Handle Arm to Body - NT50A	M5x25	5/Pk
	SP 949-757	Hex Bolt - Air Inlet Cap to Body NT50AE	M5x20	5/Pk
	SP 875-650	Hex Bolt	M5x16	1/Pk



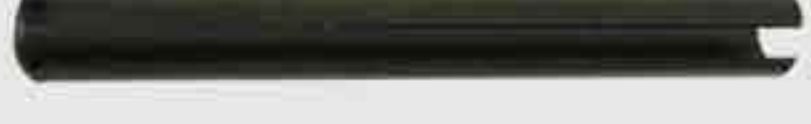



METABO / HITACHI SPRINGS / PINS / SHAFTS

	Part #	Description	Nailer / Stapler Model #
	SP 875-643	Compression Spring	NT50A
	SP 876-172	Cylinder Spring	NT50A
	SP 949-518	Roll Pin D3x18 (10/pk)	NT50AE2
	SP 949-776	Roll Pin D3x10 (10/pk)	NT50A
	SP 949-866	Roll Pin D3x30 (10/pk)	NT50A

METABO / HITACHI AFTERMARKET PARTS

	Part #	Description	Nailer / Stapler Model #
	SP 876-203	Trigger	NT50A

METABO / HITACHI AFTERMARKET PARTS

	Part #	Description	Nailer / Stapler Model #
	SP 876-179	Top Cover	NT50A
	SP 877-122	Cylinder Guide	NT50A
	SP 876-168	Cylinder Plate	NT50A
	SP 878-121	Trigger Plunger	NT50A
	SP 875-642	Safety Plunger (B)	NT50A
	SP 877-129	Head Cap Assembly	NT50A
	SP 875-645 SP 875-645R	Rubber Ball	NT50A
	SP 875-644 Replaces (887-777)	Trigger Valve Plate	NT50A
	SP 887-774	Exhaust Valve (without HOLE)	NT50A
	SP 876-174-KIT	SP 876-174 Piston O-Ring -10/Pk SP 877-761 Feeder Spring - 10/Pk	NT50A

METABO / HITACHI PISTON DRIVER

	Part #	Nailer / Stapler Model #
	SP 885-667	NT65M2





METABO / HITACHI PISTON BUMPER

	Part #	Nailer / Stapler Model #
	SP 885-669	NT65M2 - Rubber Material

METABO / HITACHI O-RINGS

AFTERMARKET O-RING KIT			
	Part #	Nailer / Stapler Model #	Qty/Pk
 <p>G866 Metabo HPT NT65M2</p>	SP 873-093	NR65AK & NT65	2/pk
	SP 877-763	NV45, NR90 & NT65	2/pk
	SP 878-888	NR65AK, NR90 & NT65	2/pk
	SP 883-992	NR65AK & NT65	2/pk
	SP 885-666	NT65M2	2/pk
	SP 885-668	NT65M2	2/pk

METABO / HITACHI NUTS / BOLTS

	Part #	Nailer / Stapler Model #	Type	Qty/Pk
	SP 877-371	Nylon Nut NT65M2	M4	5/Pk
	SP 876-465	Nylon Nut NT65M2	M4	5/Pk
	SP 949-657	Hex Socket HD Bolt NT65M2	M6x12	5/Pk
	SP 949-757	Hex Bolt - Air Inlet Cap to Body NT65M2	M5x20	5/Pk

NT65M2 PARTS

METABO/HITACHI AFTERMARKET PARTS

	Part #	Description	Nailer / Stapler Model #
	SP 882-927	Head Valve (A)	NT65M2
	SP 882-914	Head Bumper	NT65M2
	SP 885-637	Ribbon Spring	NT65M2
	SP 881-751	Nose Cap	NT65M2
	SP 884-323	Release Lock Lever	NT65M2
	SP 882-913	Head Valve Spring	NT65M2
	SP 949-866	Roll Pin D3 X 45 (10/Pk)	NT65M2

DBO65-01 - METABO HPT NT65M2 SERVICE KIT

S.No.	Part #	Description
1	SP 885-667	Aftermarket Piston Driver Assembly
2	SP 885-669	Aftermarket Piston Bumper
3	SP 873-093	Aftermarket O-Ring
4	SP 877-763	Aftermarket O-Ring
5	SP 878-888	Aftermarket O-Ring
6	SP 883-992	Aftermarket O-Ring
7	SP 885-666	Aftermarket Cylinder O-Ring
8	SP 885-668	Aftermarket Driver Piston O-Ring



METABO / HITACHI PISTON DRIVER

	Part #	Nailer / Stapler Model #
	SP 884-330	NT65MA2

METABO / HITACHI PISTON BUMPERS

	Part #	Nailer / Stapler Model #
	SP 881-741	NT65MA2

METABO / HITACHI GASKET

	Part #	Nailer / Stapler Model #
	SP 880-358	NT65MA2

METABO / HITACHI O-RINGS



	SP 877-312	SP 878-888
	SP 882-685	SP 878-925
	SP 873-093	SP 981-317
	SP 877-699	SP 876-796
	SP 878-885	
	SP 878-887	

NT65MA2 PARTS

METABO / HITACHI NUTS / BOLTS

	Part #	Nailer / Stapler Model #	Type	Qty/Pk
	SP 877-371	Nylon Nut NT65MA2	M4	5/Pk
	SP 949-657	Hex Socket HD Bolt NT65MA2	M6x12	5/Pk
	SP 949-757	Hex Bolt - Air Inlet Cap to Body NT65MA2	M5x20	5/Pk

METABO / HITACHI AFTERMARKET PARTS

	Part #	Description	Nailer / Stapler Model #
	SP 882-927	Head Valve (A)	NT65MA2
	SP 881-756	Bumper Sheet	NT65MA2
	SP 884-323	Release Lock Lever	NT65MA2
	SP 881-751	Nose Cap (A)	NT65MA2

NT65MA2 PARTS

METABO / HITACHI GASKET

	Part #	Nailer / Stapler Model #
	SP 877-137	Gasket (E) NV50AA
	SP 876-178	Gasket(C) NV50AA
	SP 877-131Q Premium Quality	Gasket(B) NV50AA

METABO / HITACHI O-RINGS

	SP 872-821	SP 877-826
	SP 876-174	SP 878-734
	SP 876-161	SP 888-151
	SP 877-126	SP 877-124
	SP 876-126	SP 874-820
	SP 876-167	SP 875-638
	SP 876-123	

NV50AA PARTS









METABO / HITACHI WASHER / NUTS

	Part #	Nailer / Stapler Model #	Type	Qty/Pk
	SP 949-454	Spring Washer NV50AA	M5	3/Pk
	SP 949-453	Spring Washer NV50AA	M4	5/Pk
	SP 949-555	Nut NV50AA	M5	10/Pk
	SP 876-465	Nylon Nut NV50AA	M4	5/Pk

METABO/HITACHI BOLTS







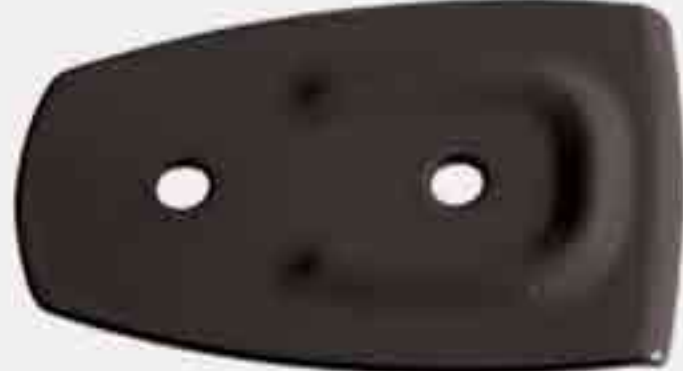

	Part #	Nailer / Stapler Model #	Type	Qty/Pk
	SP 875-650	Hex Bolt NV50AA	M5x16	5/Pk
	SP 949-757	Hex Bolt - Air Inlet Cap to Body NV50AA	M5x20	5/Pk
	SP 949-662	Hex Bolt - Magazine (2 hole) Handle Arm to Body NV50AA	M5x25	5/Pk
	SP 878-181	Hex Socket HD Bolt NV50AA	M5x16	1/Pk

METABO/HITACHI SPRING & PINS

	Part #	Nailer / Stapler Model #
	SP 876-174-KIT	SP 876-174 Piston O-Ring -10/Pk SP 877-761 Feeder Spring - 10/Pk NV50AA
	SP 876-172	Cylinder Spring NV50AA
	SP 876-676	Compression Spring
	SP 876-681	Main Stopper Spring NV50AA
	SP 877-372	Spring NV50AA
	SP 877-144	Feed Spring NV50AA
	SP 875-643	Plunger Spring (Top) NV50AA
	SP 949-866	Roll Pin D3 x 30 (10/pk) NV50AA
	SP 949-776	Roll Pin D3 x 10 (10/pk) NV50AA

NV50AA PARTS

METABO/HITACHI AFTERMARKET PARTS

	Part #	Description	Nailer / Stapler Model #
	SP 877-129	Head Cap Assembly	NV50AA
	SP 876-179	Top Cover	NV50AA
	SP 877-122	Cylinder Guide	NV50AA
	SP 878-121	Trigger Plunger	NV50AA
	SP 876-203	Trigger Lever	NV50AA
	SP 887-774	Exhaust Valve (w/o Hole)	NV50AA
	SP 875-645R	Rubber Ball	NV50AA
	SP 875-644 Replaces (887-777)	Trigger Valve Plate	NV50AA
	SP 877-335	Trigger Valve Bushing	NV50AA



NV50AA PARTS

METABO / HITACHI PISTON DRIVER

	Part #	Nailer / Stapler Model #
	SP 882-684*	NV65AH (Replaces 880-650)

* Driver with UNI-LOK®

METABO / HITACHI PISTON BUMPER

	Part #	Nailer / Stapler Model #
	SP 882-676	NV65AH
	SP 881-761	Exhaust Valve Rubber (A) NV65AH

METABO / HITACHI GASKET

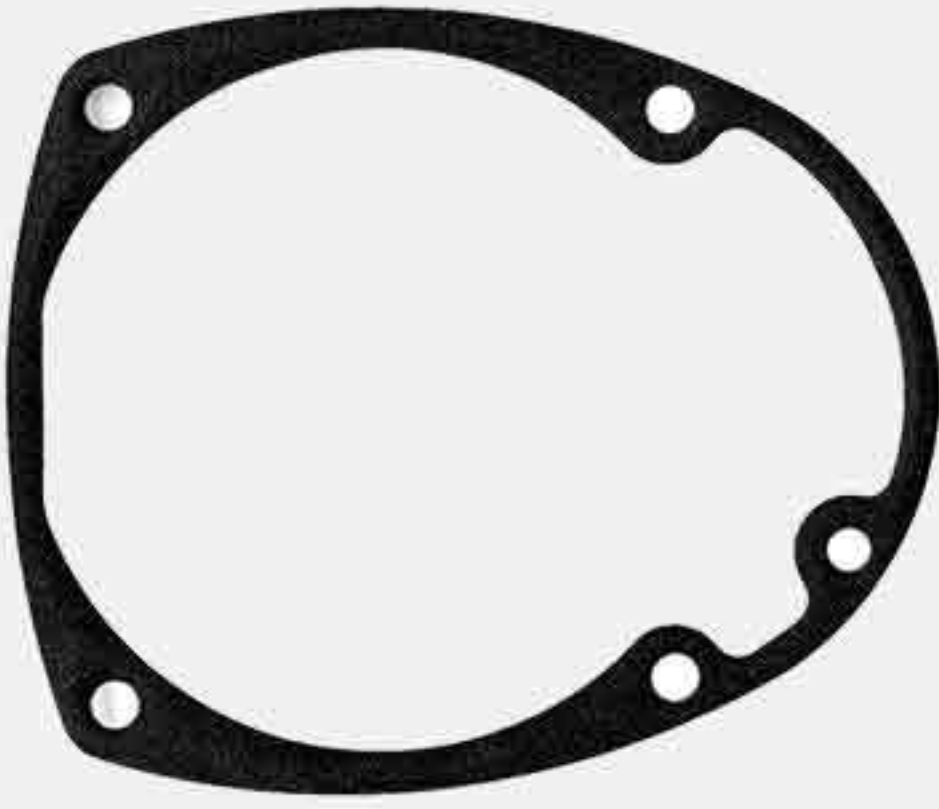
	Part #	Nailer / Stapler Model #
	SP 880-358	NV65AH

METABO / HITACHI O-RINGS

	SP 872-645	SP 878-885	SP 882-685
	SP 874-436	SP 878-887	SP 878-925
	SP 877-312	SP 878-888	SP 880-311
	SP 877-699	SP 880-358	SP 981-317
	SP 877-826		

NV65AH PARTS

METABO/HITACHI SERVICE KITS

AFTERMARKET O-RING KIT



OS65V
Metabo HPT NV65AH

Part #	Description	Qty/Pk
SP 872-645	O-Ring	2/pk
SP 874-436	O-Ring	2/pk
SP 877-312	O-Ring	2/pk
SP 877-699	O-Ring	2/pk
SP 877-826	Feeder Shaft O-Ring	5/pk
SP 878-885	O-Ring	2/pk
SP 878-887	O-Ring	2/pk
SP 878-888	O-Ring	2/pk
SP 878-925	O-Ring	2/pk
SP 880-311	O-Ring	2/pk
SP 981-317	O-Ring	2/pk
SP 301-631	Compression Spring	1/pk
SP 880-446	Compression Spring	1/pk
SP 880-494	Stopper Spring	1/pk

DB65V-01 - METABO HPT NV65AH SERVICE KIT

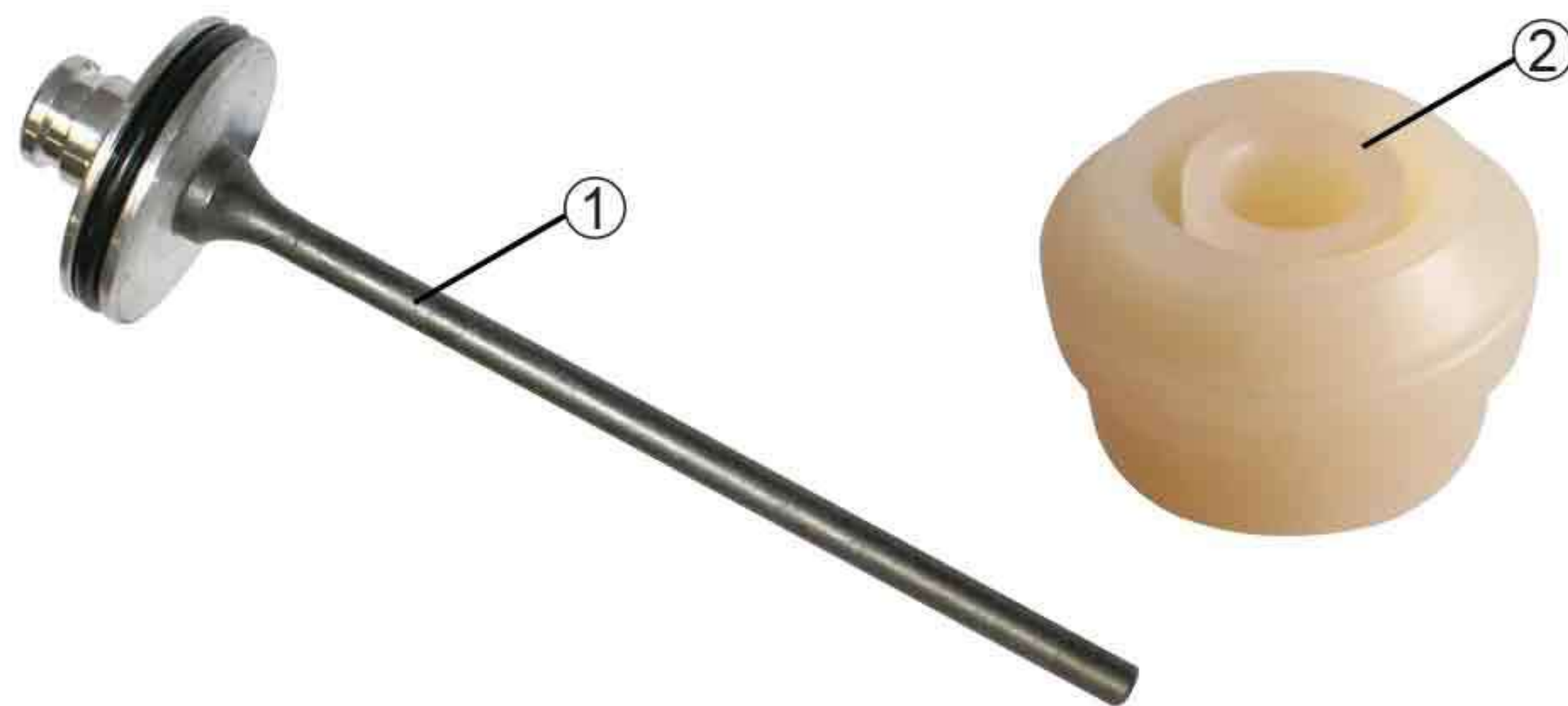





S.No.	Part #	Description
1	SP 882-684	Piston Driver Assembly
2	SP 882-676	Piston Bumper









ALL SERVICE KITS COMES IN A RETAIL READY BLISTER PACK

METABO/HITACHI SPRING

	Part #	Nailer / Stapler Model #
	SP 301-631	Compression Spring NV65AH
	SP 880-175	Compression Spring (2/Pk) NV65AH
	SP 880-398	Ratchet Spring NV65AH
	SP 880-446	Compression Spring NV65AH
	SP 880-494	Stopper Spring NV65AH

METABO / HITACHI WASHER / NUTS / BOLTS / BALL

	Part #	Nailer / Stapler Model #	Type	Qty/Pk
	SP 959-148	Steel Ball NV65AH	-	2/Pk
	SP 880-081	Washer NV65AH	-	2/Pk
	SP 877-371	Nylon Nut NV65AH	M4	5/Pk
	SP 876-465	Nylon Nut NV50AA	M4	5/Pk
	SP 949-657	Hex Socket HD Bolt NV65AH	M6x10	5/Pk
	SP 949-230	Machine Bolt NV65AH	M4x50	10/Pk

NV65AH PARTS



METABO / HITACHI PISTON DRIVER

	Part #	Nailer / Stapler Model #
	SP 888-423	NV75AN

METABO / HITACHI PISTON BUMPER

	Part #	Nailer / Stapler Model #
	SP 888-429	NV75AN

METABO / HITACHI GASKET

	Part #	Nailer / Stapler Model #
	SP 888-421	NV75AN
	SP 888-418	Collar NV75AN

METABO / HITACHI O-RINGS

	SP 888-419	SP 888-425
	SP 888-420	SP 888-426
	SP 888-422	SP 888-459



METABO / HITACHI

OEM METABO/HITACHI PARTS

	Part #	Description	Nailer / Stapler Model #
	883-511	Piston Bumper (B)	NR83A, NR83A2, NR83A2(S)
	877-393Z	Nail Feeder	NR83A, NR83A2, NR83A2(S)
	884-065	Magazine Base	NR83A, NR83A2
	885-827	Magazine Assembly 1-Hole	NR83A, NR83A2, NR83A2(S), NR83A3, NR83A3S
	18000	O-Ring Kit	NR83A, NR83A2, NR83A2(S)
	884-063	Magazine Assembly 1-Hole	NR83A, NR83A2, NR83A2(S), NR83A3, NR83A3S
	878-422	Ribbon Spring	NR83A, NR90AA, NR83AA, NR83A2, NR83A5
	877-307	Head Cap / Gasket Set	NR83A, NR83A2, NR83A2(S)
	888-256	Push Lever (A)	NR83A2(S), NR83A3, NR83A3(S)
	875-645 890-301	Urethane Ball (C)	NR83A / A2 / A2S



METABO / HITACHI

	Part #	Description	Nailer / Stapler Model #
	887-902	Pushing Lever (B)	NR83A3, NR83A3(S)
	887-906	Pushing Lever (C)	NR83A2(Y), NR83A3, NR83A3(S)
	889-357 Replaces 889-125	Pushing Lever	NR83A5
	889-089	Trigger Spring	NR83A5
	889-099	Pushing Lever (C)	NR83A5
	889-094	Trigger Arm Spring	NR83A5
	889-098	Trigger Plunger	NR83A5
	883-901	Feeder (A)	NV45AB/AB2
	883-432	Piston Bumper	NR65AK/AK2/AK(S), NV75AG
	883-440	Ribbon Spring	NR65AK/AK2/AK2(S)
	883-450	Cylinder	NR65AK/AK(S)/AK2, NV75AG, NV85AG

OEM METABO/HITACHI PARTS



METABO / HITACHI

OEM METABO/HITACHI PARTS

	Part #	Description	Nailer / Stapler Model #
	883-436	Nail Feeder	NR65AK
	883-452	Gasket (B)	NR65AK/AK2/AK2(S) NV75AG, NV85AG,
	883-457	Magazine	NR65AK/AK2/AK2(S)
	882-914	Head Bumper	NR65AK, NV75AG
	881-949	Cap	NR65AK, NR90AC, NR90AC2
	883-442	Sleeve	NR65AK
	883-447	Guard	NR65AK/AK(S)/AK2
	883-455	Pushing Lever Guide	NR65AK/AK(S)/AK2
	883-459	Guide Plate	NR65AK/AK(S)/AK2
	883-458	Nail Rail	NR65AK/AK(S)/AK2
	884-332	Top Cover	NT65MA2, NT65M, NV75AG
	882-927	Head Valve (A)	NR65AK, NT65MA2



METABO / HITACHI

	Part #	Description	Nailer / Stapler Model #
	882-913	Head Valve Spring	NR65AK
	883-461	Magazine Cover	NR65AK
	883-462	Nail Gate	NR65AK
	883-471	Piston Driver Assembly	NR65AK
	883-891	Protector	NV45AB2, NV45AE
	889-099	Pushing Lever	NR83A
	877-310	Cylinder Guide	NR83A/A2/A2(S)
	889-096	Trigger Pin	NR83A5, NV83A5
	889-087	Cylinder Guide	NR83A5/A5(S), NV83A5
	889-088	Valve Bushing (A)	NR83A5, NV83A5
	889-103	Plunger(B) Spring	NR83A5, NV83A5

OEM METABO/HITACHI PARTS



METABO / HITACHI

OEM METABO/HITACHI PARTS

	Part #	Description	Nailer / Stapler Model #
	889-102	Plunger (B)	NR83A5, NV83A5
	884-075	Guard	NR83A2/A2(S)/ A3/A3(S) /A5/A5(S)
	884-112	O-Ring (2/Pk)	NR83A5, NV83A5
	885-666	Cylinder Ring	NT65M2



	Part #	Description	Nailer / Stapler Model #
	SP MV11 OE Part# 405374	Trigger Valve Kit	CN55/70/80
	SP MV11A	Aluminum Body Trigger Valve Kit	CN55/70/80
	SP CN81201	Cylinder Vap Unit	CN55
	SP MB55	Piston Bumper	CN55
	SP MB70	Piston Bumper Set	CN70/80/90
	SP AA82427	Hex Bolt - 8 x 20	CN55, CN80, CN80F
	SP BB40413	Hex Bolt -M6x22	CN55, CN445R, CN450R

MAX PARTS



	Part #	Description	Nailer / Stapler Model #
	SP BB40428	Hex Bolt - M6x25	CN445R, CN450R, CN55, CN70 & GS732C
	SP BB40443	Hex Bolt - M8x25	CN665, CN70, SN883RH & SN890CH
	SP BB40457	Hex Bolt -M6x36	CN55, CN70, CN890II, HN120, HS130, TA551/76
	SP BB40487	Hex Bolt - M8x25	CN70, CN100
	SP KK23123	Compression Spring	CN55, CN70, CN80 & CN80F
	SP KK23195	Compression Spring	CN70, CN80 & CN80F
	SP KK23223	Compression Spring	CN70 & CN80
	SP KK23225	Compression Spring	CN70, CN80, CN890F & CN890S
	SP KK23256	Compression Spring	CN55 & HN120
	SP KK23257	Compression Spring	CN55
	SP KK23258	Compression Spring	CN70 & CN80
	SP KK23578	Compression Spring	CN55
	SP KK13144	Tension Spring	CN55, CN70, CN80, CN80F, CN100
	SP KK23578	Compression Spring	CN55, CN70, CN80, CN80F, CN100

MAX PARTS



	Part #	Description	Nailer / Stapler Model #
	SP KK24123	Compression Spring	CN55, CN100, SN883RH & CN890RH
	SP KK33058	Torsion Spring	CN55/70/80/80F
	SP CC00402	Elastic Stop Nut M6x1	CN55, CN70, CN80, CN100
	SP CN70481	Washer 8	CN70
	SP EE39138	Washer	CN55, CN601J, CN80, CN80F
	SP EE39602	Rubber Washer 7	CN55, CN70, CN80, CN100
	SP EE39603	Post Retainer	CN55, CN80, CN80F, CN100, CN550S
	SP EE39608	Post Retainer	CN70
	SP FF21220	Roll Pin 3 x 16	CN55, CN70, CN80, CN80F, CN100
	SP FF21234	Roll Pin 3 x 12	CN55, CN70, CN80, CN80F, HN25C
	SP FF21254	Roll Pin 3 x 28	CN55, NF255, TA238, NF255-ST/18
	SP FF31127	Straight Solid Steel Pin 4 x 72	CN70, CN80, CN80F
	SP FF31251	Step Pin 1251	CN55, CN550S



MAX PARTS

	Part #	Description	Nailer / Stapler Model #
	SP FF41263	Step Pin 1263	CN55, CN70, CN80, CN80F
	SP FF41286	Step Pin	CN70, CN80, CN80F
	SP FF41287	Step Pin	CN70, CN80, CN80F
	SP FF41501	Step Pin	CN55
	SP FF41502	Step Pin 1502	CN55
	SP CN31083	Hook Dust Cover	CN55, CN70, CN80, CN80F
	SP CN31346	Trigger Valve Cap	CN55, CN70, CN80, CN100
	SP CN31347	Trigger Valve Stem	CN55, CN70, CN80, CN80F, CN100
	SP CN31568	Feed Pawl	CN70
	SP CN31575	Nail Support Unit	CN70
	SP CN31589	Pilot Valve	CN55, CN70, CN80, CN100
	SP CN31875	Feed Pawl	CN55
	SP CN31878	Spring Guide	CN55



	Part #	Description	Nailer / Stapler Model #
	SP CN31882	Dust Shield	CN55
	SP CN32170	Collar	CN55, CN70, CN80, CN100
	SP CN32247	Trigger Valve Housing	CN55, CN70, CN80 CN80F, CN100
	SP CN32631	Exhaust Cover Holder	CN55, CN80, CN80F
	SP CN35821	Contact Arm	CN55
	SP CN35823	Nail Support	CN55
	SP CN35827	Contact Arm	CN70
	SP CN37371	Door Latch	CN55, CN70, CN80, CN80F
	SP CN37372	Piston Stop	CN70
	SP CN37373	Head Valve Piston	CN55
	SP CN37374	Cylinder Ring	CN55, CN450R

MAX PARTS



	Part #	Description	Nailer / Stapler Model #
	SP CN37375	Cylinder Seal	CN55
	SP CN37376	Exhaust Cover Seal	CN55, CN80, CN80F
	SP CN37377	Feed Piston Stop	CN55
	SP CN37378	Spacer	CN55
	SP CN37379	Nose	CN55
	SP CN37380	Door	CN55
	SP CN37381	Check Pawl	CN55
	SP CN37382	Magazine Post	CN55, CN80, CN80F
	SP CN37383	Spring Holder	CN55, CN70, CN80, CN100
	SP CN37394	Contact Arm Guide	CN55

MAX PARTS



	Part #	Description	Nailer / Stapler Model #
	SP CN37395	Contact Arm Cover-A	CN55
	SP CN37397	Feed Piston	CN55
	SP CN37399	Spring Collar	CN55
	SP CN37403	Exhaust Filter	CN55, CN80, CN80F
	SP CN37404	Exhaust Spacer	CN55
	SP CN37406	Nail Support	CN55
	SP CN37409	Head Valve Washer	CN55
	SP CN37413	Magazine	CN55
	SP CN37415	Cylinder Cap Seal	CN55
	SP CN37416	Contact Arm Cover-B	CN55



MAX PARTS

	Part #	Description	Nailer / Stapler Model #
	SP CN37418	Protector	CN55
	SP CN37420	Magazine Cover	CN55
	SP CN37423	Trigger	CN55, CN70, CN80, CN80F, CN100
	SP CN37424	Contact Lever	CN55, CN70, CN80, CN80F, CN100
	SP CN37521	Nose	CN70
	SP CN37522	Door	CN70
	SP CN37523	Check Pawl	CN70, CN80, CN80F, CN100
	SP CN37525	Piston Stop	CN70
	SP CN37526	Head Valve Piston	CN70



	Part #	Description	Nailer / Stapler Model #
	SP CN37527	Cylinder Seal	CN70, CN80, CN80F
	SP CN37528	Feed Piston Stop	CN70, CN80, CN80F, HS90, CN890S
	SP CN37530	Magazine Post	CN70
	SP CN37403	Contact Arm Cover	CN70, CN80
	SP CN37537	Feed Piston	CN70
	SP CN37538	Spring Collar	CN70, CN80, CN80F, CN890S
	SP CN37545	Magazine	CN70
	SP CN37547	Head Valve Washer	CN70, CN80, CN80F
	SP CN37549	Cylinder Cap Seal	CN70, CN80, CN80F

MAX PARTS



	Part #	Description	Nailer / Stapler Model #
	SP CN37552	Magazine Cover	CN70
	SP CN37553	Contact Arm Cover-B	CN70
	SP JJ22407	Retaining Ring C26	CN55, CN70, CN80, CN80F, CN100
	SP CN35289	Piston Stop	CN550S, CN565D, CN565S, CN665, CN665D, NF550-15-65

MAX PARTS

MAX® PISTON DRIVER

	Part #	Nailer / Stapler Model #
	SP CN81200C*	CN55 (Japanese Carbide Blade)

* Driver with UNI-LOK®

MAX® PISTON BUMPER

	Part #	Nailer / Stapler Model #
	SP MB55	CN55

MAX® O-RINGS

	SP HH11101	SP HH11151	SP HH11909
	SP HH11113	SP HH11156	SP HH19125
	SP HH11119	SP HH11157	SP HH19197
	SP HH11132	SP HH11159	SP HH19198
	SP HH11138	SP HH11209	SP HH12106
	SP HH11143	SP HH11901	SP HH12118













CN55 PARTS

MAX AFTERMARKET PARTS

	Part #	Description	Nailer / Stapler Model #
	SP MV11A	Aluminum Body Trigger Valve Kit	CN55
	SP CN81201	Cylinder Vap Unit	CN55
	SP AA82427	Hex Bolt - 8 x 20	CN55
	SP BB40413	Hex Bolt -M6x22	CN55
	SP BB40428	Hex Bolt - M6x25	CN55
	SP BB40457	Hex Bolt -M6x36	CN55
	SP KK23123	Compression Spring	CN55
	SP KK23256	Compression Spring	CN55
	SP KK23257	Compression Spring	CN55
	SP KK23578	Compression Spring	CN55
	SP KK13144	Tension Spring	CN55
	SP KK23578	Compression Spring	CN55

CN55 PARTS

MAX AFTERMARKET PARTS

	Part #	Description	Nailer / Stapler Model #
	SP KK24123	Compression Spring	CN55
	SP KK33058	Torsion Spring	CN55
	SP CC00402	Elastic Stop Nut M6x1	CN55
	SP EE39138	Washer	CN55
	SP EE39602	Rubber Washer 7	CN55
	SP EE39603	Post Retainer	CN55
	SP FF21220	Roll Pin 3 x 16	CN55
	SP FF21234	Roll Pin 3 x 12	CN55
	SP FF21254	Roll Pin 3 x 28	CN55
	SP FF31251	Step Pin 1251	CN55
	SP FF41263	Step Pin 1263	CN55
	SP FF41501	Step Pin	CN55
	SP FF41502	Step Pin 1502	CN55

CN55 PARTS

MAX AFTERMARKET PARTS

	Part #	Description	Nailer / Stapler Model #
	SP CN31083	Hook Dust Cover	CN55
	SP CN31346	Trigger Valve Cap	CN55
	SP CN31347	Trigger Valve Stem	CN55
	SP CN31589	Pilot Valve	CN55
	SP CN31875	Feed Pawl	CN55
	SP CN31878	Spring Guide	CN55
	SP CN37395	Contact Arm Cover-A	CN55
	SP CN37397	Feed Piston	CN55
	SP CN37399	Spring Collar	CN55
	SP CN37403	Exhaust Filter	CN55
	SP CN37404	Exhaust Spacer	CN55
	SP CN37406	Nail Support	CN55

CN55 PARTS

MAX AFTERMARKET PARTS

	Part #	Description	Nailer / Stapler Model #
	SP CN37409	Head Valve Washer	CN55
	SP CN37413	Magazine	CN55
	SP CN37415	Cylinder Cap Seal	CN55
	SP CN37416	Contact Arm Cover-B	CN55
	SP CN37418	Protector	CN55
	SP CN37420	Magazine Cover	CN55
	SP CN37423	Trigger	CN55
	SP CN37424	Contact Lever	CN55
	SP JJ22407	Retaining Ring C26	CN55

CN55 PARTS



PISTON DRIVER

	Part #	Nailer / Stapler Model #
	SP CN81204C*	CN70 (Japanese Carbide Blade)

* Driver with UNI-LOK®



PISTON BUMPER

	Part #	Nailer / Stapler Model #
	SP MB70	CN70 Piston Bumper Set



O-RINGS

	SP HH11113	SP HH11157	SP HH19142
	SP HH11119	SP HH11159	SP HH19195
	SP HH11132	SP HH11209	SP HH19196
	SP HH11138	SP HH11901	
	SP HH11143	SP HH19125	
	SP HH11151	SP HH19139	













CN70 PARTS



	Part #	Description	Nailer / Stapler Model #
	SP MV11 OE Part# 405374	Trigger Valve Kit	CN70
	SP MV11A	Aluminum Body Trigger Valve Kit	CN70
	SP BB40428	Hex Bolt - M6x25	CN70
	SP BB40443	Hex Bolt - M8x25	CN70
	SP BB40457	Hex Bolt - M6x36	CN70
	SP BB40487	Hex Bolt - M8x25	CN70
	SP KK23123	Compression Spring	CN70
	SP KK23195	Compression Spring	CN70
	SP KK23223	Compression Spring	CN70
	SP KK23225	Compression Spring	CN70
	SP KK23258	Compression Spring	CN70

CN70 PARTS



	Part #	Description	Nailer / Stapler Model #
	SP KK13144	Tension Spring	CN70
	SP KK23578	Compression Spring	CN70
	SP KK33058	Torsion Spring	CN70
	SP CC00402	Elastic Stop Nut M6x1	CN70
	SP CN70481	Washer 8	CN70
	SP EE39602	Rubber Washer 7	CN70
	SP EE39608	Post Retainer	CN70
	SP FF21220	Roll Pin 3 x 16	CN70
	SP FF21234	Roll Pin 3 x 12	CN70
	SP FF31127	Straight Solid Steel Pin 4 x 72	CN70
	SP FF41263	Step Pin 1263	CN70
	SP FF41286	Step Pin	CN70
	SP FF41287	Step Pin	CN70
	SP CN31083	Hook Dust Cover	CN70









CN70 PARTS



	Part #	Description	Nailer / Stapler Model #
	SP CN31346	Trigger Valve Cap	CN70
	SP CN31347	Trigger Valve Stem	CN70
	SP CN31568	Feed Pawl	CN70
	SP CN31575	Nail Support Unit	CN70
	SP CN31589	Pilot Valve	CN70
	SP CN32170	Collar	CN70
	SP CN32247	Trigger Valve Housing	CN70
	SP CN35827	Contact Arm	CN70
	SP CN37371	Door Latch	CN70
	SP CN37372	Piston Stop	CN70
	SP CN37383	Spring Holder	CN70
	SP CN37423	Trigger	CN70









CN70 PARTS



	Part #	Description	Nailer / Stapler Model #
	SP CN37424	Contact Lever	CN70
	SP CN37521	Nose	CN70
	SP CN37522	Door	CN70
	SP CN37523	Check Pawl	CN70
	SP CN37525	Piston Stop	CN70
	SP CN37526	Head Valve Piston	CN70
	SP CN37527	Cylinder Seal	CN70
	SP CN37528	Feed Piston Stop	CN70
	SP CN37530	Magazine Post	CN70

CN70 PARTS



	Part #	Description	Nailer / Stapler Model #
	SP CN37403	Contact Arm Cover	CN70
	SP CN37537	Feed Piston	CN70
	SP CN37538	Spring Collar	CN70
	SP CN37545	Magazine	CN70
	SP CN37547	Head Valve Washer	CN70
	SP CN37549	Cylinder Cap Seal	CN70
	SP CN37552	Magazine Cover	CN70
	SP CN37553	Contact Arm Cover-B	CN70
	SP JJ22407	Retaining Ring C26	CN70

CN70 PARTS



PISTON DRIVER

	Part #	Nailer / Stapler Model #
	SP CN81206C*	CN80 & CN80F (Japanese Carbide Blade)

* Driver with UNI-LOK®



PISTON BUMPER

	Part #	Nailer / Stapler Model #
	SP MB70	CN80 Piston Bumper Set







O-RINGS

	SP HH11113	SP HH11157	SP HH19142
	SP HH11119	SP HH11159	SP HH19195
	SP HH11132	SP HH11209	SP HH19196
	SP HH11138	SP HH11901	
	SP HH11143	SP HH19125	
	SP HH11151	SP HH19139	















	Part #	Description	Nailer / Stapler Model #
	SP MV11 OE Part# 405374	Trigger Valve Kit	CN80
	SP MV11A	Aluminum Body Trigger Valve Kit	CN80
	SP MB70	Piston Bumper Set	CN80
	SP AA82427	Hex Bolt - 8 x 20	CN80
	SP KK23123	Compression Spring	CN80
	SP KK23195	Compression Spring	CN80
	SP KK23223	Compression Spring	CN80
	SP KK23225	Compression Spring	CN80
	SP KK23258	Compression Spring	CN80
	SP KK13144	Tension Spring	CN80











	Part #	Description	Nailer / Stapler Model #
	SP KK23578	Compression Spring	CN80
	SP KK33058	Torsion Spring	CN80
	SP CC00402	Elastic Stop Nut M6x1	CN80
	SP EE39138	Washer	CN80
	SP EE39602	Rubber Washer 7	CN80
	SP EE39603	Post Retainer	CN80
	SP FF21220	Roll Pin 3 x 16	CN80
	SP FF21234	Roll Pin 3 x 12	CN80
	SP FF31127	Straight Solid Steel Pin 4 x 72	CN80
	SP FF41263	Step Pin 1263	CN80
	SP FF41286	Step Pin	CN80
	SP FF41287	Step Pin	CN80
	SP CN31083	Hook Dust Cover	CN80



	Part #	Description	Nailer / Stapler Model #
	SP CN31346	Trigger Valve Cap	CN80
	SP CN31347	Trigger Valve Stem	CN80
	SP CN31589	Pilot Valve	CN80
	SP CN32170	Collar	CN80
	SP CN32247	Trigger Valve Housing	CN80
	SP CN32631	Exhaust Cover Holder	CN80
	SP CN37371	Door Latch	CN80
	SP CN37376	Exhaust Cover Seal	CN80
	SP CN37382	Magazine Post	CN80
	SP CN37383	Spring Holder	CN80
	SP CN37403	Exhaust Filter	CN80
	SP CN37423	Trigger	CN80



	Part #	Description	Nailer / Stapler Model #
	SP CN37424	Contact Lever	CN80
	SP CN37523	Check Pawl	CN80
	SP CN37527	Cylinder Seal	CN80
	SP CN37528	Feed Piston Stop	CN80
	SP CN37403	Contact Arm Cover	CN80
	SP CN37538	Spring Collar	CN80
	SP CN37547	Head Valve Washer	CN80
	SP CN37549	Cylinder Cap Seal	CN80
	SP JJ22407	Retaining Ring C26	CN80



	Part #	Description	Nailer / Stapler Model #
	SP BC0741	Valve	JoistPro250XP
	SP BC0742	Seal	JoistPro250XP
	SP BC0743	Collar	JoistPro250XP
	SP 250XPB	Bumper	JoistPro250XP
	SP 250XPG	Head Cap Gasket	JoistPro250XP

SENCO PARTS



PASLODE PARTS

	Part #	Description	Nailer / Stapler Model #
	SP 501006	Compression Spring	F350S, F400S, F250S-PP, F325C
	SP 501500	Liver Spring	F250S-PP
	SP 402011	Seal / Sleeve	F350S, F250S-PP, F325-C, F400C
	SP 402041	Torsion Spring	R175C, 3175RC, 65C, 90C, 75C
	SP 500407	Spring, Main Valve	F350S
	SP 500513	Ribbon Spring	F350S
	SP 501283	Cylinder	F350S
	SP 502311	Piston Seal	PF150S-PP



PISTON DRIVER

	Part #	Nailer / Stapler Model #
	SP 501468*	F250S

* Driver with UNI-LOK®



PISTON BUMPER

	Part #	Nailer / Stapler Model #
	SP 500866	F250S



AFTERMARKET PARTS

	Part #	Description	Nailer / Stapler Model #
	SP 501006	Compression Spring	F250S
	SP 501500	Liver Spring	F250S
	SP 092971	Piston Driver O-Ring (2pk)	F250S
	SP 402011	Seal / Sleeve	F250S

F250S PARTS



PISTON DRIVER

	Part #	Nailer / Stapler Model #
	SP 501468*	F350S

* Driver with UNI-LOK®



PISTON BUMPER

	Part #	Nailer / Stapler Model #
	SP 500866	F350S



GASKET

	Part #	Nailer / Stapler Model #
	SP 501001	F350S

F350S PARTS



AFTERMARKET PARTS

	Part #	Description	Nailer / Stapler Model #
	SP 501006	Compression Spring	F350S
	SP 502042	O-Ring	F350S
	SP 402011	Seal / Sleeve	F350S
	SP 500407	Spring, Main Valve	F350S
	SP 500513	Ribbon Spring	F350S
	SP 501283	Cylinder	F350S

F350S PARTS



	Part #	Description	Nailer / Stapler Model #
	SP 100315	Feed Pawl Pin	RN45B
	SP 101408	Latch Spring	RN45B
	SP 122592	Door Pin	RN45B
	SP 149831	Torsion Spring Door Latch	RN46
	SP 149859	Feed Pawl Spring	RN46
	SP 149882	Pin-Check Pawl	RN46
	SP 149886	Pin-Door Latch	RN46
	SP 149898	Spring-Check Pawl	RN46
	SP N65042	Feeding Pawl Spring	RN45B
	SP N12112	Retaining Ring	RN46
	TVA6	Bostitch OEM Trigger Valve Kit	RN45, RN46, N80C, N100
	SP 100298	Spiral Pin M3 x 30 (10/Pk)	BT125
	SP 174062	Stepped Pin	MCN250S
	SP Bostitch Kit	Piston Head Repair Kit	CF15, MCN250S, MCN150 N75C, N66C, N66BC MCN250, N66BC-1 N75C-1, N66C-1
	174049	Seal Deflector	Replaces P2320006800
	174051	Compression Spring	Replaces P2325700600
	174052	Special Washer	Replaces P2325208062

BOSTITCH PARTS



PISTON DRIVER

	Part #	Nailer / Stapler Model #
	SP 149826*	RN46

* Driver with UNI-LOK®



PISTON BUMPER

	Part #	Nailer / Stapler Model #
	SP 191777	RN46



O-RING KIT

Aftermarket O-Ring Kit



SP BOS-RN46OR

Part #	Qty/Kit
SP 149828	1 Pc
SP 149842	1 Pc
SP 850766	1 Pc
SP 850607	2 Pcs
SP 850607-OS	1 Pc
SP 149829	1 Pc
SP 149883	1 Pc
SP 88998	1 Pc
SP N12112	2 Pcs









OEM TRIGGER VALVE KIT









	Part #	Nailer / Stapler Model #
	TVA6	RN46



AFTERMARKET PARTS

	Part #	Description	Nailer / Stapler Model #
	SP 149831	Torsion Spring Door Latch	RN46
	SP 149859	Feed Pawl Spring	RN46
	SP 149898	Spring-Check Pawl	RN46
	SP 149882	Pin-Check Pawl	RN46
	SP 149886	Pin-Door Latch	RN46
	SP N12112	Retaining Ring	RN46



	Part #	Description	Nailer / Stapler Model #
	SP 888531	Door Torsion Spring	RN175
	SP 898341	Pin	RN175
	SP 899460	Spring	RN175
	SP 907198	Feeder Torsion Spring	RN175
	SP 907207	Door Spring	RN175
	SP 907208	Pin	RN175
	SP 897359	Retaining Ring	RN175
	SP N078434	Spring	PCE201, PCC641LB

PORTER CABLE PARTS



PISTON DRIVER

	Part #	Nailer / Stapler Model #
	SP G0209200U	DW66



PISTON BUMPER

	Part #	Nailer / Stapler Model #
	SP 174054	DW66

DW66 PARTS



PISTON DRIVER

	Part #	Nailer / Stapler Model #
	SP 150744-3	AN611





PISTON BUMPER

	Part #	Description	Nailer / Stapler Model #
	SP 421575-0	Cushion Guide	AN611

	Part #	Description	Nailer / Stapler Model #
	FN83A	Flush Nailer	NR83A
	SP 889-357F	Pushing Lever with Flush Nailer (889-125)	NR83A5
	SP 887-906F	Pushing Lever (C) with Flush Nailer	NR83A/A2/A2(S)/A3
	M745	Rafter Spring Hook Universal Bracket	Skil Saw & Metabo HPT NR83A
	M745RB	Spring Loaded Rafter Round "U" Hook - Black	Metabo HPT NR83A, NR83A2, NR90AE & Skil Worm Drive Saw
	M745W	"Wide" Version Rafter Spring Hook Universal Bracket	Skil Saw & Metabo HPT NR83A
	M745-SH	Rafter Spring Hook for Worm Drive Saw	Skil Worm Drive Saw Skil P/N 2610913915
	M745H1	Rafter Spring Hook 1 Hole Bracket	NR83A2/NR90AE



HOOKS & ACCESSORIES

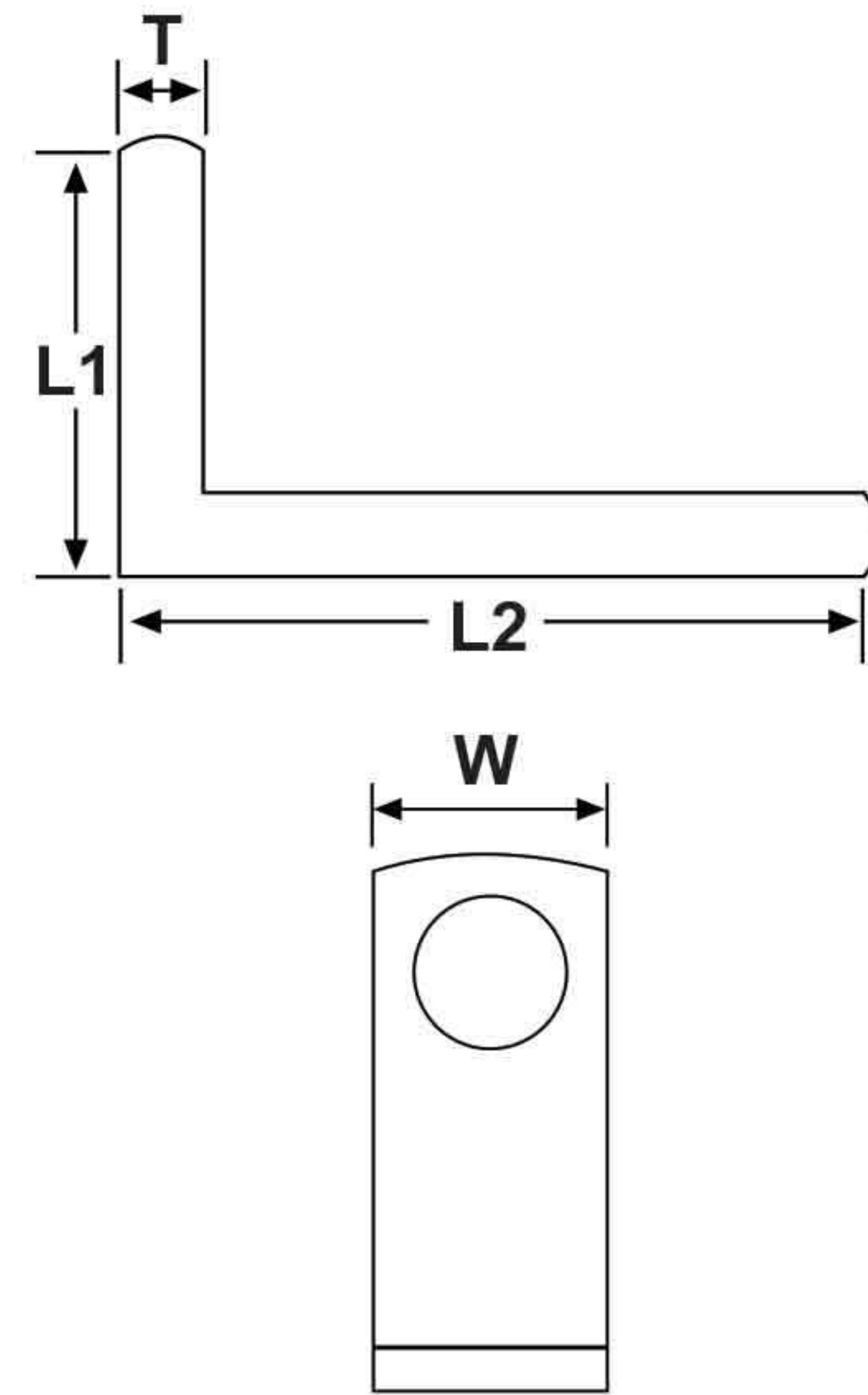

	Part #	Description	Nailer / Stapler Model #
	M745H1W	"Wide" Version Rafter Spring Hook 1 Hole Bracket	NR83A2/NR90AE
	M745H2	Rafter Spring Hook 2 Hole Bracket	NR83A
	M745H2W	"Wide" Version Rafter Spring Hook 2 Hole Bracket	NR83A
	M750P	Spring Loaded Rafter Hook	Paslode 501347
	M760M	Spring Loaded Rafter Hook	Max KN 81035
	M765	Spring Loaded Rafter Hook	Metabo HPT NV75AG Max CN890F, CM565S2

	Part #	Description	Nailer / Stapler Model #
	GH1	L-Hook 3/8"	--
	GH2	L-Hook 1/4"	--
	GH3	U-Hook Steel	NR83A/A2
	GH4	L-Hook 1/4" & 3/8" (Aluminum)	
	GH4-SS	L-Hook 1/4" & 3/8" (Stainless Steel)	
	GH5	L-Hook 1/4" (small)	
	GH6	L-Hook 1/4" (short)	
	GH9	L- Hook 3/8"	
	SP 889-111 L-Hook		NR83A5



Part #	T	W	L1	L2
GH1	3/16"	1-1/4"	4-1/4"	5"
GH2	3/16"	1-1/4"	4-1/4"	5"
GH4	3/16"	1-1/4"	4-1/4"	4-1/4"
GH4-SS	3/16"	1-1/4"	4-1/4"	4-1/4"
GH5	3/16"	1"	2-3/4"	3-3/4"
GH6	3/16"	1"	4-1/4"	2-1/2"
GH9	3/16"	1"	2-15/16"	3-3/16"
SP 889-111	3/35"	2-1/16"	4-7/8"	4-1/16"

	Part #	Description
	GH7	Drill / Power Tool Holder with Metal Clip Belt
	GH8	Belt Clip Tool Holder System with 3 Ball Bungees

	Part #	Description
	BL1	Cordless Tool Holster / Air Nailer Hook
	BL2-1BM	Belt Clip Tool Holder System with 1 Ball Bungees
	BL2-3BM	Belt Clip Tool Holder System with 3 Ball Bungees

Superior Electric® utilizes best in class materials for its range of electrical cords to give better electrical conductivity and enhanced durability. Contract manufacturing procedures correspond to modern standards that result in exceptional products in terms of quality, performance and reliability. Leading features of **Superior Electric®** cords are as follows:

Superior Electrical Conductivity – Our cords use high grade and high-purity copper that contains oxygen as an alloying agent, which is best suited for bulk of electrical conductor applications because of its high electrical conductivity and improved annealability.



Copper cables are braided to provide better flexibility to the cord and make it impact resistant.

High Quality Insulation – **Superior Electric®** offers 3 types of cords **SJO, SJTW & STOOW**

The **'S'** and **'J'** letters in each of these types mean that they are **Junior Service**. Junior service simply means that the voltage rating of the cord is 300 volts. A single **'O'** designates an oil resistant outer jacket, while the double **'OO'** stands for oil resistant insulation and an oil resistant outer jacket. Finally, the **'W'** stands for weather and water resistant, and is CSA approved for indoor or outdoor use.

CORD	SJO	SJTW	STOOW
Features	<ul style="list-style-type: none"> • Oil & moisture resistant • Good tensile strength, elongation and aging characteristics • High flexibility • Excellent abrasion resistance 	<ul style="list-style-type: none"> • Oil, Water, Acid, Alkali, and Ozone resistant • Approved for outdoor use • Flame retardant • Flexible 	<ul style="list-style-type: none"> • Oil-resistant jacket • Oil, Acids, Alkalis, Ozone resistant
Applications	<ul style="list-style-type: none"> • SJO Cords may be used for portable tools and equipment • Portable appliances, small motors and associated machinery. 	<ul style="list-style-type: none"> • SJT Cord is hard usage service cord designed for use with heavy tools, equipment, portable lights and power extensions. • It is also used with large appliances and lighting installations. 	<ul style="list-style-type: none"> • Designed for extra hard usage with heavy tools, equipment, portable lights and power extensions.
Insulation	<ul style="list-style-type: none"> • Premium grade, color coded 90°C EPDM on SJO Cable • Jute fiber for insulation and toughness 	<ul style="list-style-type: none"> • Premium-grade oil-resistant PVC (black) 	<ul style="list-style-type: none"> • Premium-grade, color-coded Polyvinylchloride (PVC)
Jacket	<ul style="list-style-type: none"> • Black • Temperature Range: -40°C to +90°C 	<ul style="list-style-type: none"> • Black • Temperature Range: -34°C to +105°C 	<ul style="list-style-type: none"> • Black • Temperature Range: -40°C to +60°C













You can tell what type of jacket the cord has by reading the letters as well. A thermoplastic elastomer jacket will have the letter "E", usually after the "S" or "SJ" depending on the service type. A thermoplastic jacket will have a "T" instead of an "E" in the same spot. The absence of an "E" or a "T" means it has a thermoset rubber jacket.

Superior Electric® cords feature an extra cushion of insulation of Jute Fiber. Advantages of jute include enhanced insulating and antistatic properties, as well as having low thermal conductivity and moderate moisture regain. It also improves the toughness and durability of the cord. Moreover, Jute fiber is 100% bio-degradable and recyclable and thus environmentally friendly.



Standardized Safety – All **Superior Electric®** cords are UL approved. UL (Underwriters Laboratories) approved product means that UL has tested representative samples of the product and determined that it meets UL's requirements.

ELECTRICAL STANDARD CORDS

	Part #	Wire	AWG	Voltage	Amperage	Wattage	Length	Insulated for	Type	NEMA
	EC123	3	12	125 V	15 A	1875 W	9Ft.	300 V	SJO	 5-15P
	EC123-15	3	12	125 V	15 A	1875 W	15Ft.	300 V	SJO	 5-15P
	EC142	2	14	125 V	15 A	1875 W	9Ft.	300 V	SJO	 1-15P
	SE3604460507	2	14	125 V	15 A	1875 W	10Ft.	600 V	SOOW	 1-15P
	EC142-16	2	14	125 V	15 A	1875 W	16Ft.	300 V	SJO	 1-15P
	EC142-100	2	14	125 V	15 A	1875 W	100Ft.	300 V	SJO	 1-15P
	EC142V6	2	14	125 V	15 A	1875 W	9Ft.	600 V	SOOW	 1-15P
	EC143V6	3	14	125 V	15 A	1875 W	9Ft.	600 V	SOOW	 5-15P
 Soldered Eyelets	EC143	3	14	125 V	15 A	1875 W	9Ft.	300 V	SJO	 5-15P
	EC143-16	3	14	125 V	15 A	1875 W	16Ft.	300 V	SJO	 5-15P

12 GAUGE

14 GAUGE

CORDS























ELECTRICAL STANDARD CORDS

14 GAUGE











CORDS

16 GAUGE

	Part #	Wire	AWG	Voltage	Amperage	Wattage	Length	Insulated for	Type	NEMA
 Duo-Fast OE # 441352 (GO-316)	EC143-16Q	3	14	125 V	15 A	1875 W	16Ft.	300 V	SJO	 5-15P
	EC143-25	3	14	125 V	15 A	1875 W	25Ft.	300 V	SJO	 5-15P
	EC143-100	3	14	125 V	15 A	1875 W	100Ft.	300 V	SJO	 5-15P
 Soldered Eyelets Orange Color	EC143V6-15R	3	14	125 V	15 A	1875 W	15Ft.	600 V	STOOW	 5-15P
	EC162	2	16	125 V	13 A	1625 W	9Ft.	300 V	SJO	 1-15P
 Milwaukee OE # 48-76-5010	EC162Q	2	16	125 V	13 A	1625 W	9Ft.	300 V	SJO	 1-15P
	EC162-16	2	16	125 V	13 A	1625 W	16Ft.	300 V	SJO	 1-15P
	EC162V6	2	16	125 V	13 A	1625 W	9Ft.	600 V	SOOW	 1-15P
	EC163	3	16	125 V	13 A	1625 W	9Ft.	300 V	SJO	 5-15P
	EC163-16	3	16	125 V	13 A	1625 W	16Ft.	300 V	SJO	 5-15P



ELECTRICAL STANDARD CORDS

	Part #	Wire	AWG	Voltage	Amperage	Wattage	Length	Insulated for	Type	NEMA
	EC163-25	3	16	125 V	13 A	1625 W	25Ft.	300 V	SJO	 5-15P
	EC163V6	3	16	125 V	13 A	1625 W	9Ft.	600 V	SOOW	 5-15P
 Soldered Eyelets Orange Color	EC163V6-8.5R	3	16	125 V	13 A	1625 W	8.5Ft.	600 V	STOOW	 5-15P
	EC182	2	18	125 V	10 A	1250 W	9Ft.	300 V	SJO	 1-15P
	EC183	3	18	125 V	10 A	1250 W	9Ft.	300 V	SJO	 5-15P

16 GAUGE

18 GAUGE

ELECTRICAL TWIST-LOCK CORDS

	Part #	Wire	AWG	Voltage	Amperage	Wattage	Length	Insulated for	Type	NEMA
	EC123T	3	12	125 V	15 A	1875 W	9Ft.	300 V	SJO	 L5-20P
	EC143T	3	14	125 V	15 A	1875 W	9Ft.	300 V	SJO	 L5-20P
	EC163T	3	16	125 V	13 A	1625 W	9Ft.	300 V	SJO	 L5-20P

12 GAUGE

14 GAUGE

16 GAUGE

CORDS



QUICK-LOCK POWER CORDS

14 GAUGE



Part #	Wire	AWG	Voltage	Amperage	Wattage	Length	Insulated for	Type	NEMA
EC142M	2	14	125 V	15A	1875 W	10Ft.	300 V	SJO	1-15P

Milwaukee OE # 48-76-5125



EC162M	2	16	125 V	13 A	1625 W	10Ft.	300 V	SJO	1-15P
--------	---	----	-------	------	--------	-------	-------	-----	-------

Milwaukee OE # 48-76-5010

16 GAUGE



EC163DW	3	16	125 V	13 A	1625 W	10Ft.	300 V	SJO	5-15P
---------	---	----	-------	------	--------	-------	-------	-----	-------

Dewalt OE # 399063-00



EC183M	3	18	125 V	10 A	1250 W	8Ft.	300 V	SJO	5-15P
--------	---	----	-------	------	--------	------	-------	-----	-------

Milwaukee OE # 48-76-3008,
48-76-4008

18 GAUGE



EC183TM	3	18	125 V	10 A	1250 W	8Ft.	300 V	SJO	5-15P
---------	---	----	-------	------	--------	------	-------	-----	-------

Milwaukee OE # 48-76-4108



CORDS



ELECTRICAL EXTENSION CORDS

	Part #	Wire AWG	Voltage	Amperage	Wattage	Length	Insulated for	Type	NEMA		
12 GAUGE		EC123-50E	3	12	125 V	15 A	1875 W	50Ft.	300 V	SJTW	
											
12 GAUGE		EC123-100E	3	12	125 V	15 A	1875 W	100Ft.	300 V	SJTW	
											
14 GAUGE		EC143-50E	3	14	125 V	15 A	1875 W	50Ft.	300 V	SJTW	
											
14 GAUGE		EC143-100E	3	14	125 V	15 A	1875 W	100Ft.	300 V	SJTW	
											





Part#
BOOT A
Fits EC14/3 Cord

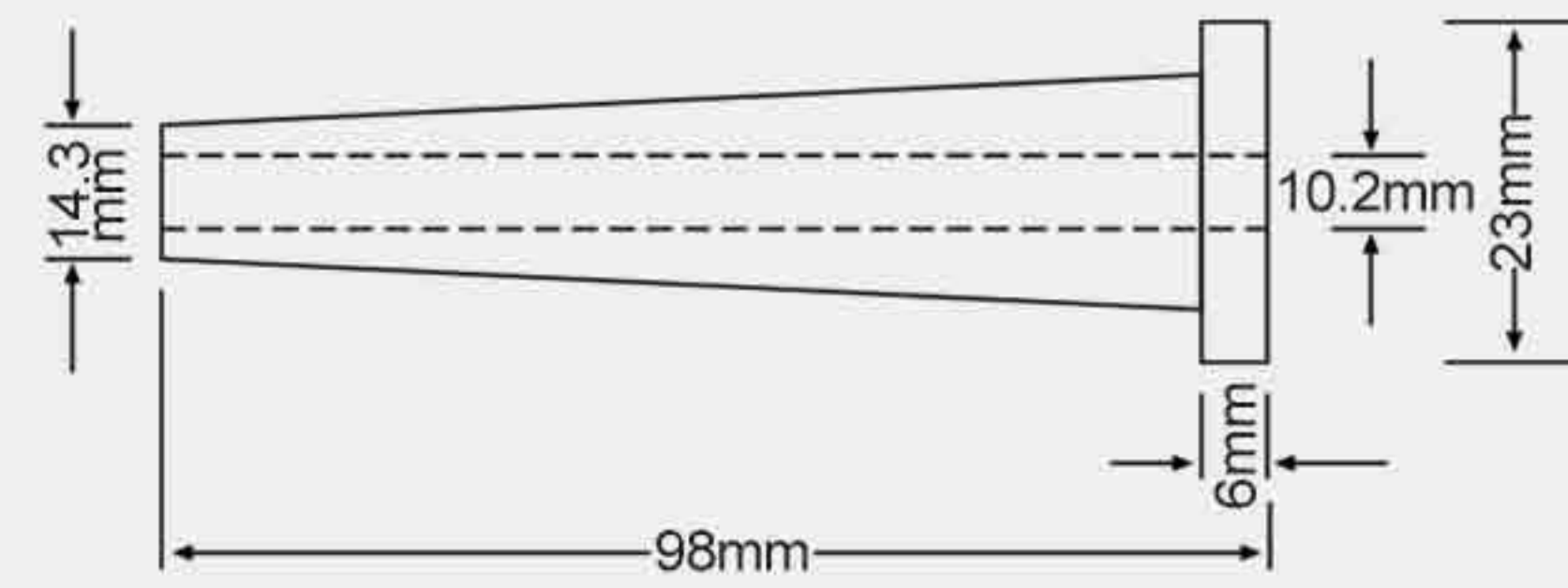

Part#
BOOT A2
Replaces Bosch
1610703011

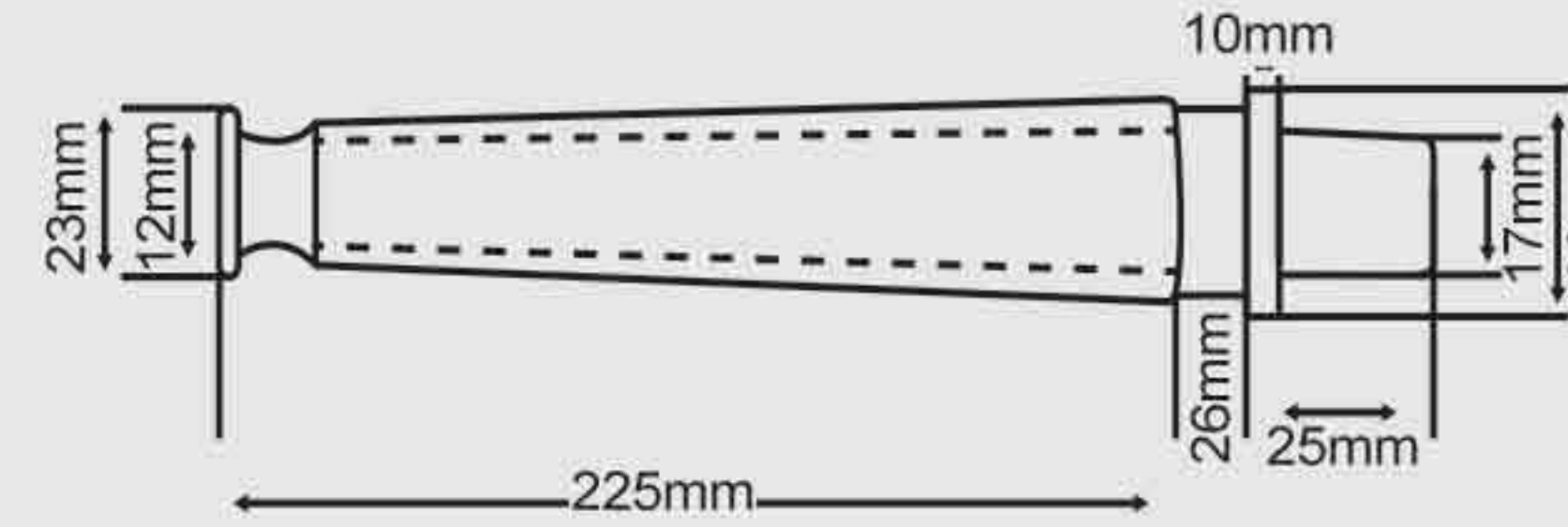

Part#
BOOT B
Fits EC14/2,
EC16/2 & EC16/3
Cords

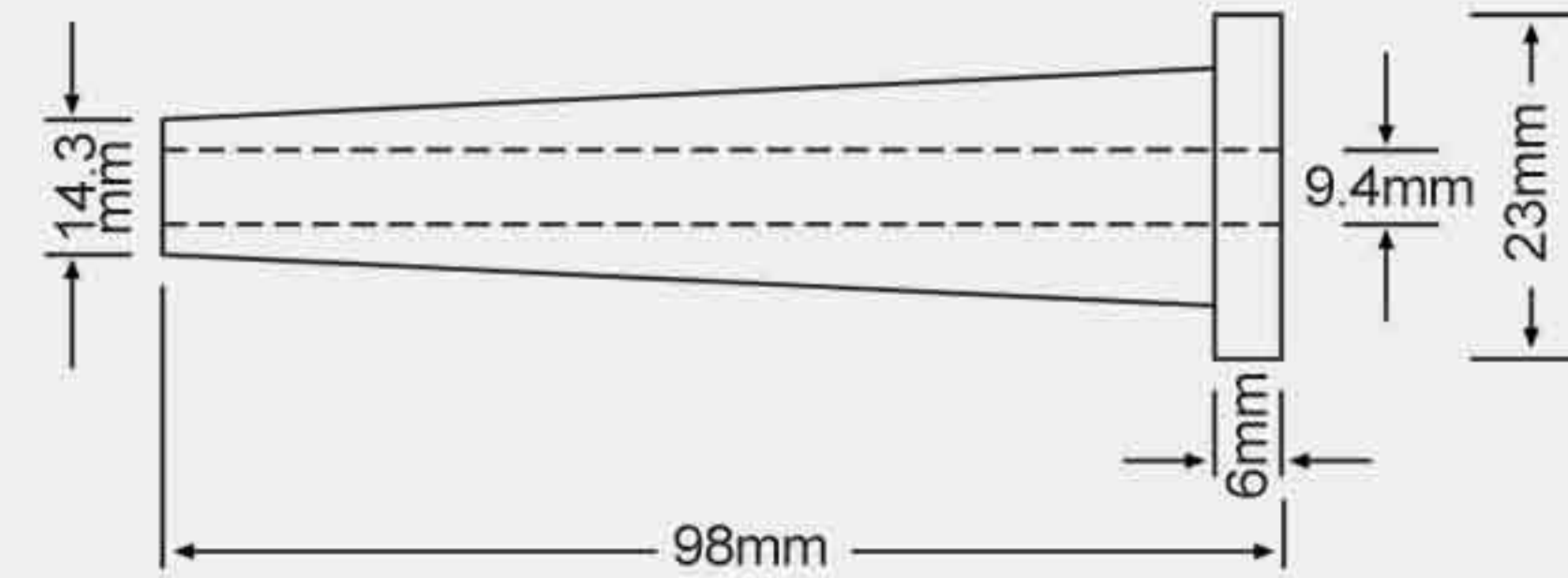

Part#
BOOT C
Fits EC18/2 Cord

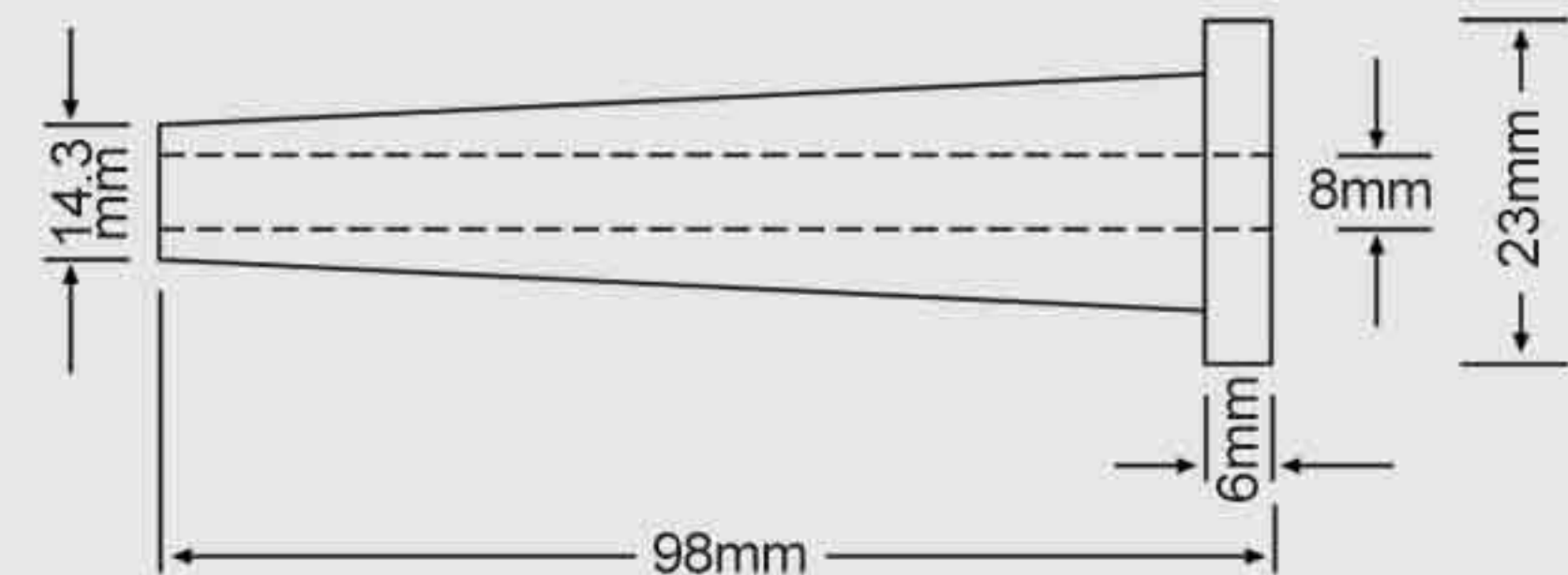

Part#
BOOT DW
Replaces Dewalt
P/N 330005-01
Fits EC14/2, EC16/2, EC16/3,
& EC18/3 Cords

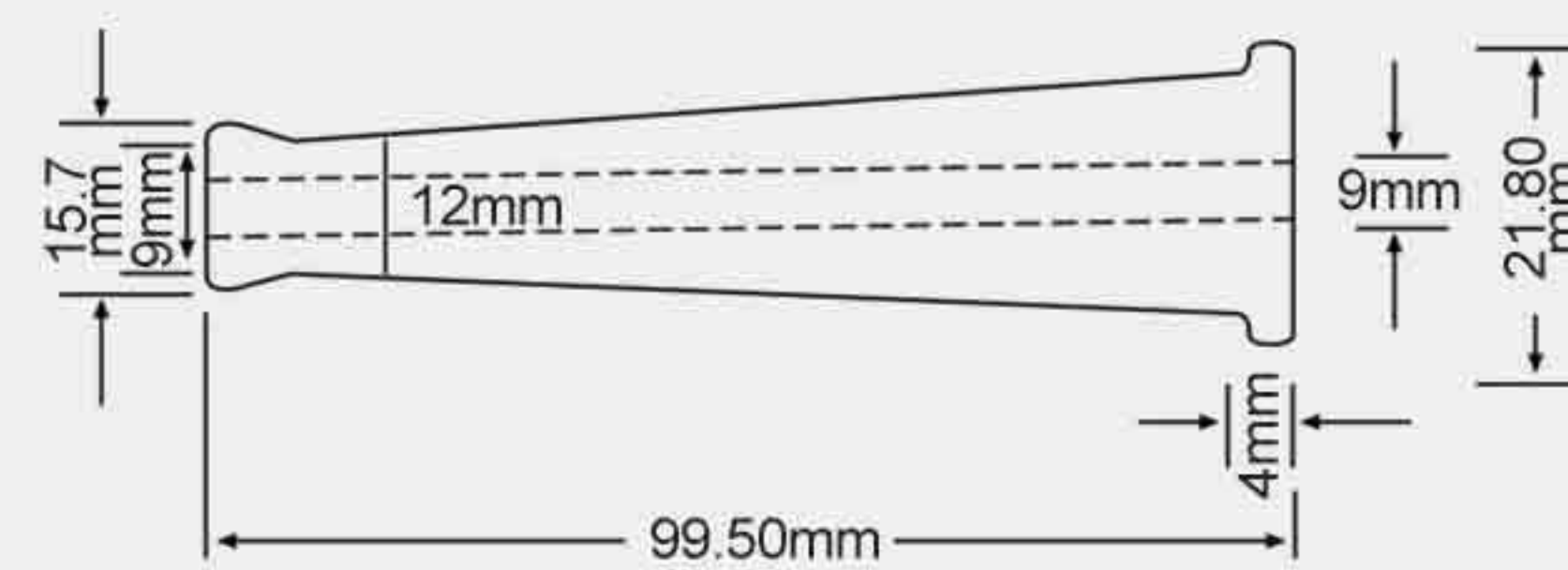

Part#
BOOT M
Replaces Milwaukee
P/N 44-76-0210
Fits EC12/3 & EC14/3
Cords

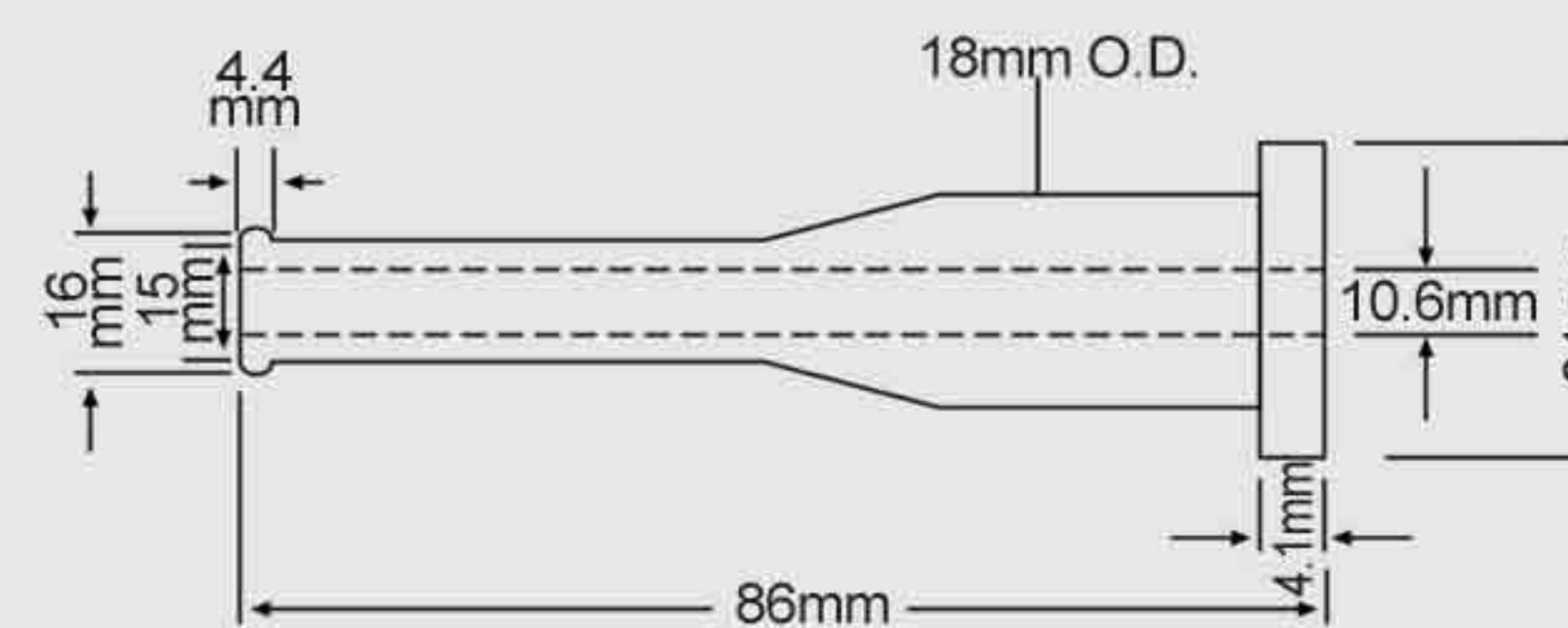

Part#
BOOT N
Replaces Makita
P/N 682505-8
Fits EC14/3 & EC12/3
Cords

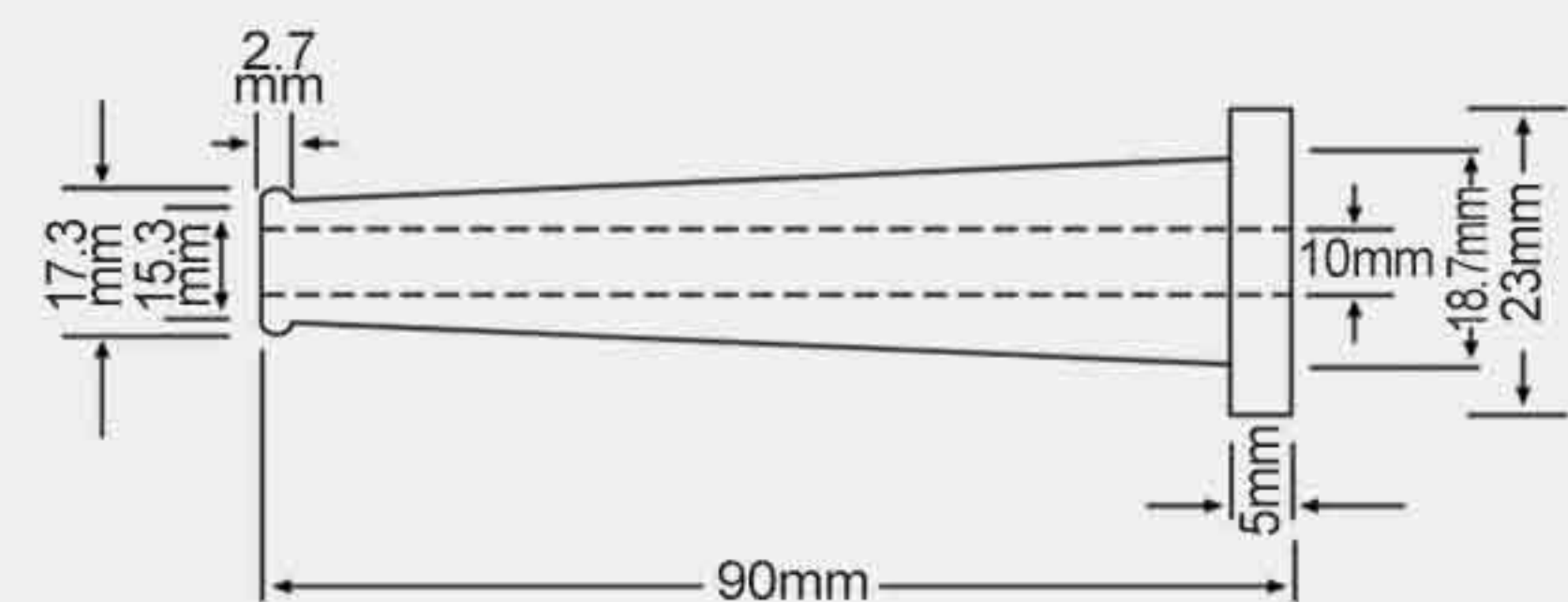

Part#
BOOT N1
Replaces Makita
682547-2

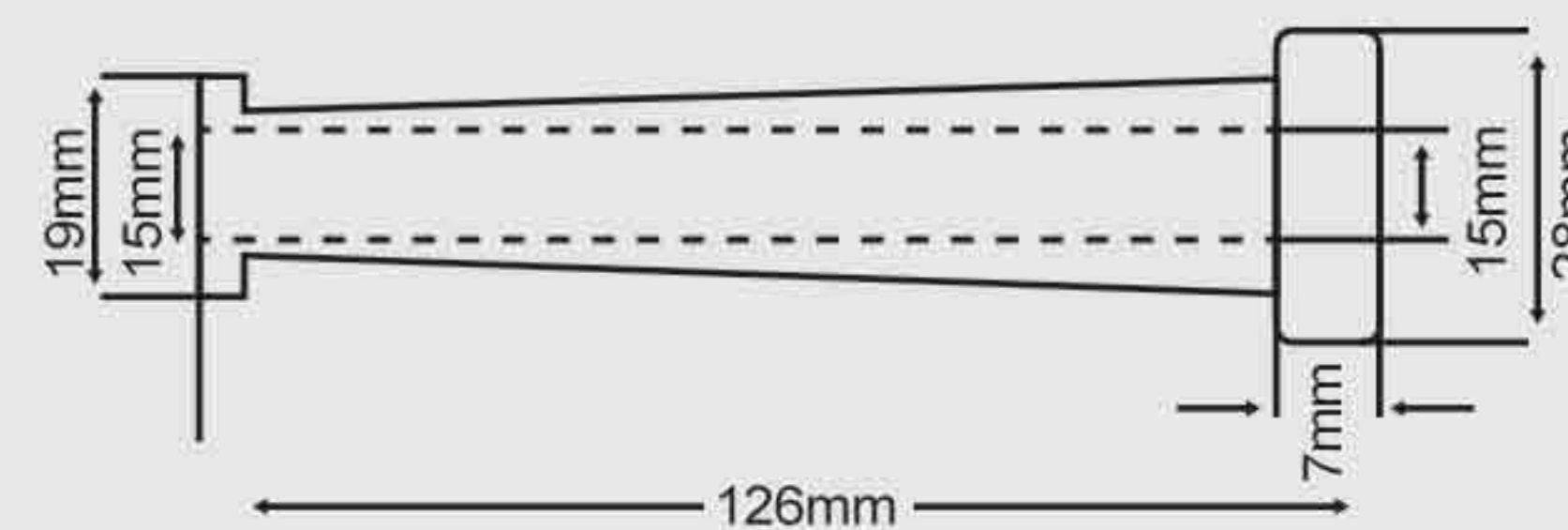

Part#
BOOT N2
Replaces Makita
682578-1

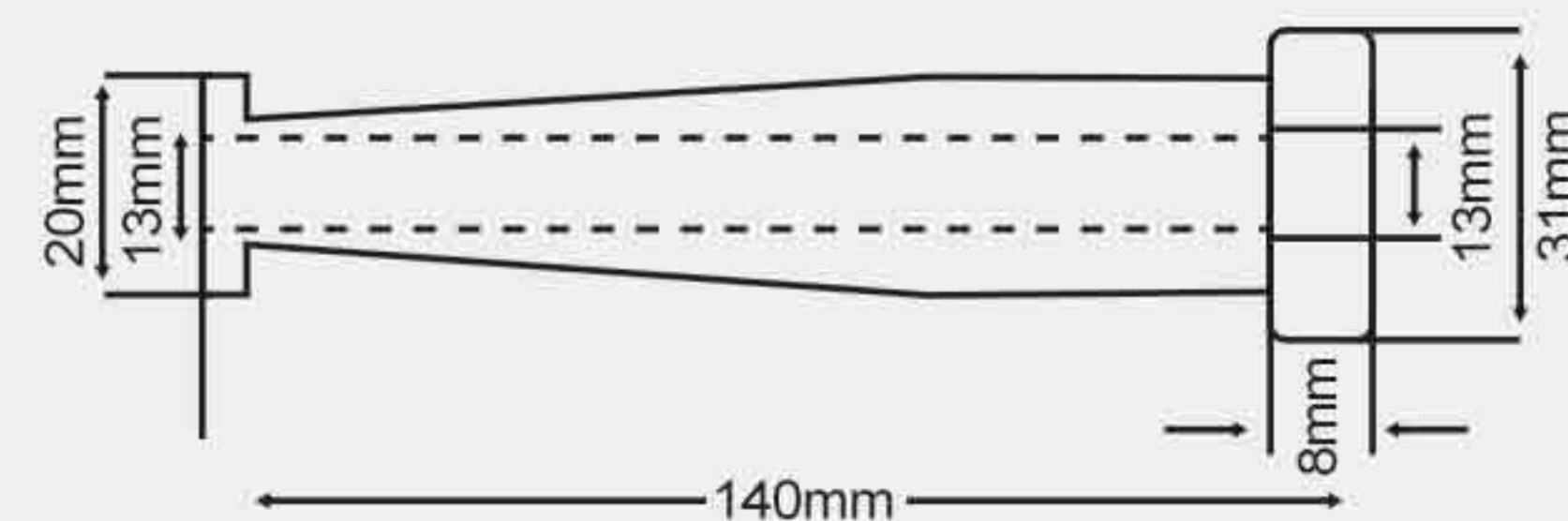

ALSO AVAILABLE AS 10/PACK - JUST ADD "-10PK" AFTER PART# FOR ORDERING.

	<p>Part# BOOT E1 Cord Protector Strain Relief Rubber Boot</p>	
	<p>Part# BOOT E2 Cord Protector Strain Relief Rubber Boot</p>	
	<p>Part# BOOT E3 Cord Protector Strain Relief Rubber Boot</p>	
	<p>Part# BOOT E4 Cord Protector Strain Relief Rubber Boot</p>	

ALSO AVAILABLE AS 10/PACK - JUST ADD "-10PK" AFTER PART# FOR ORDERING.



Part#: SE 1543

Specifications:

- ▶ 2 Transformer spaced outlet & 4 standard spaced outlets
- ▶ Easy cord wrap 6 Foot 14 Gauge grounded power cord
- ▶ 6 standard spaced outlets
- ▶ Electrical rating 125 Volt / 15 Amp / 1875 W
- ▶ Lighted power on/off switch



Part#: SE 1544

Specifications:

- ▶ 3 transformer spaced outlets. Lets you plug in over sized plugs without disturbing nearby outlets
- ▶ 5 standard spaced outlets
- ▶ Easy cord wrap 6 Foot 14 Gauge grounded power cord
- ▶ Electrical rating 125 Volt / 15 Amp / 1875 W
- ▶ Lighted power on/off switch



STORAGE STRAP



RVA1541-5
Fabric Cord
Carrying Storage
Strap - 5pcs/pk

CORD CARRIER



RVA1542-5
Plastic Cord Storage
and Carrier - 5pcs/pk

Connectors

These connectors are designed to achieve functionally reliable circuits. Offered variety includes different types of connectors including Butt Splice Wire Connectors, Nylon Crimp Closed End Caps Wire Connectors and Non-Insulated Electrical Female Quick Disconnects.

Terminals

Engineered and designed to perfection and manufactured with precision, **Superior Electric**® terminals are great in performance and value. **Superior Electric's**® range of terminals includes ring and fork/spade terminals.

Both **Superior Electric**® connectors and terminals are available in different AWG ratings including 14, 16 and 22.

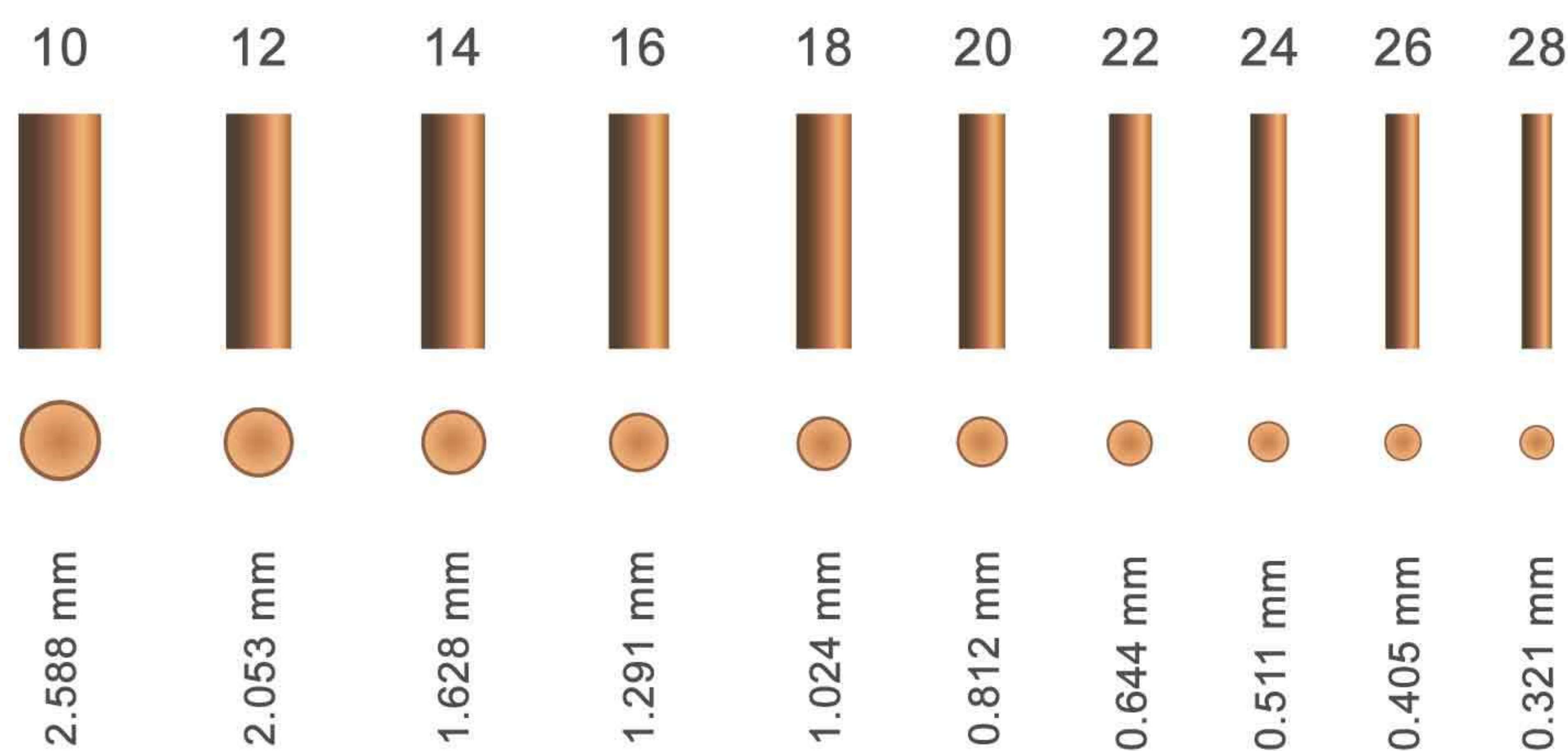



Standardized Safety – All **Superior Electric**® connectors and terminals are UL approved. UL (Underwriters Laboratories) approved product means that UL has tested representative samples of the product and determined that it meets UL's requirements.

Wire Stripper

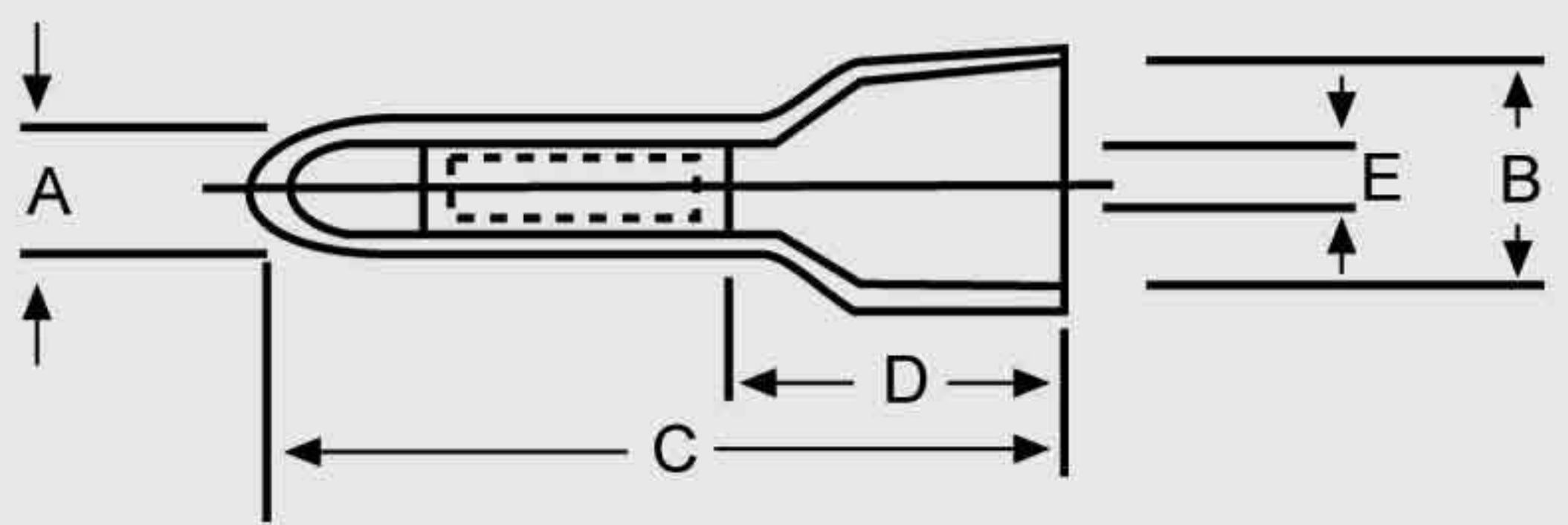
Superior Electric's® wire stripper features self adjusting jaws making it a great tool for stripping insulations from electrical wires. Ergonomic design and light weight adds to the convenience of the operator.

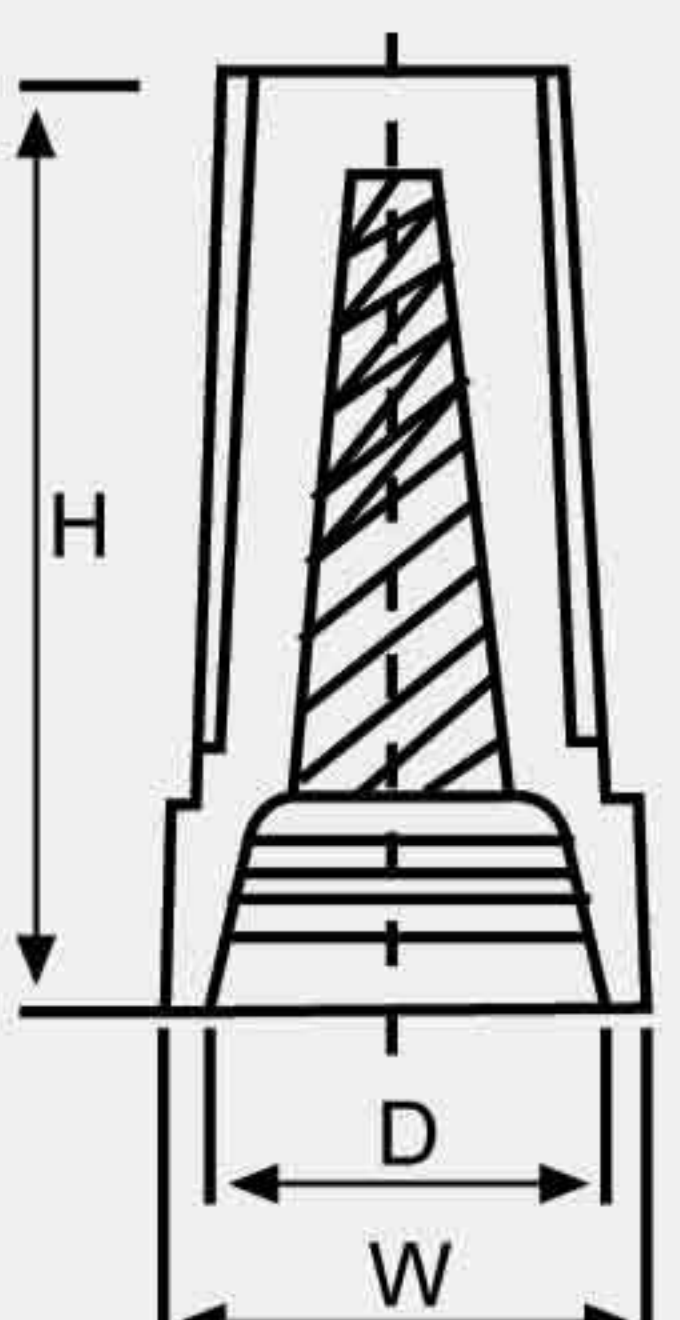
CLOSED END CONNECTORS	Part #	A mm	B mm	C mm	D mm	E mm	A.W.G.	Packing
 	CE-2	5.50	9.00	20.10	7.00	3.00	14 - 16	25 Pcs
	CE-5	7.55	10.50	25.50	8.50	4.00	12 - 14	25 Pcs

WIRE NUT CONNECTORS	Part #	H mm	W mm	D mm	Suitable Wire	Packing
 	E-1 (Grey)	15	8.7	6.5	Min # 20x1+ # 22x1 Max # 16x2	25 Pcs
	E-2 (Blue)	18	10	7.5	Min # 20x3 Max # 16x3	25 Pcs

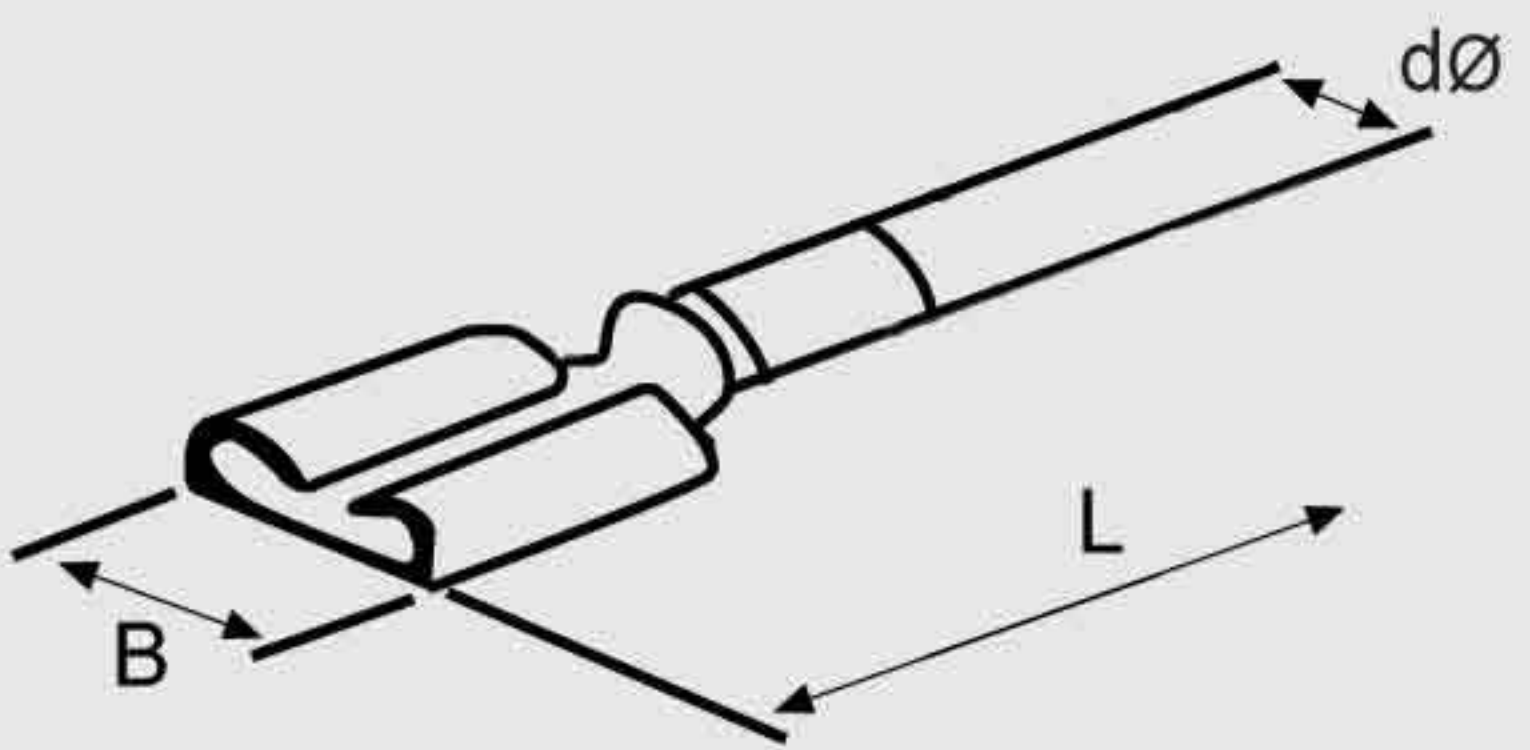
BRASS TINNED FEMALE CONNECTORS	Part #	B mm	L mm	DØ mm	A.W.G.	Packing
 	D28	3.2	13.5	2.3	16 - 14	25 Pcs
	D63	6.6	16	2.3	16 - 14	25 Pcs

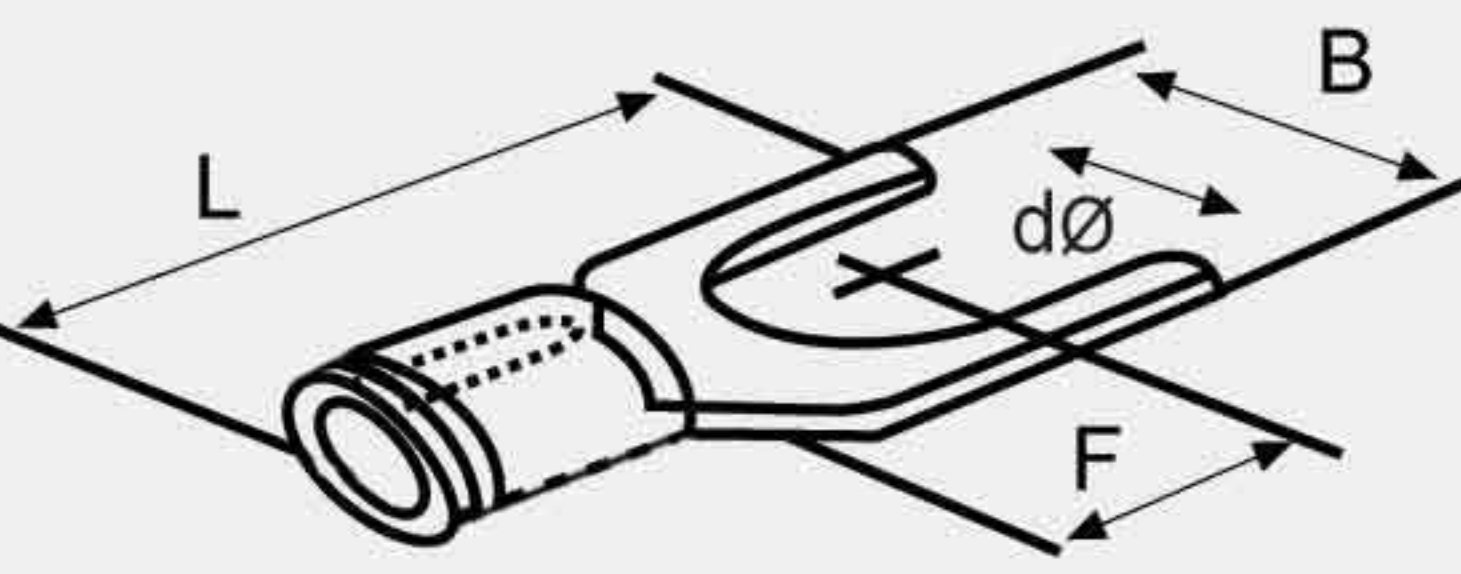
COPPER TINNED FORK TERMINALS	Part #	B mm	L mm	F mm	DØ mm	A.W.G.	Packing
 	Y23	5.8	16.5	2.3	2.3	16 - 14	25 Pcs
	Y24	7.2	16.5	2.3	2.3	16 - 14	25 Pcs

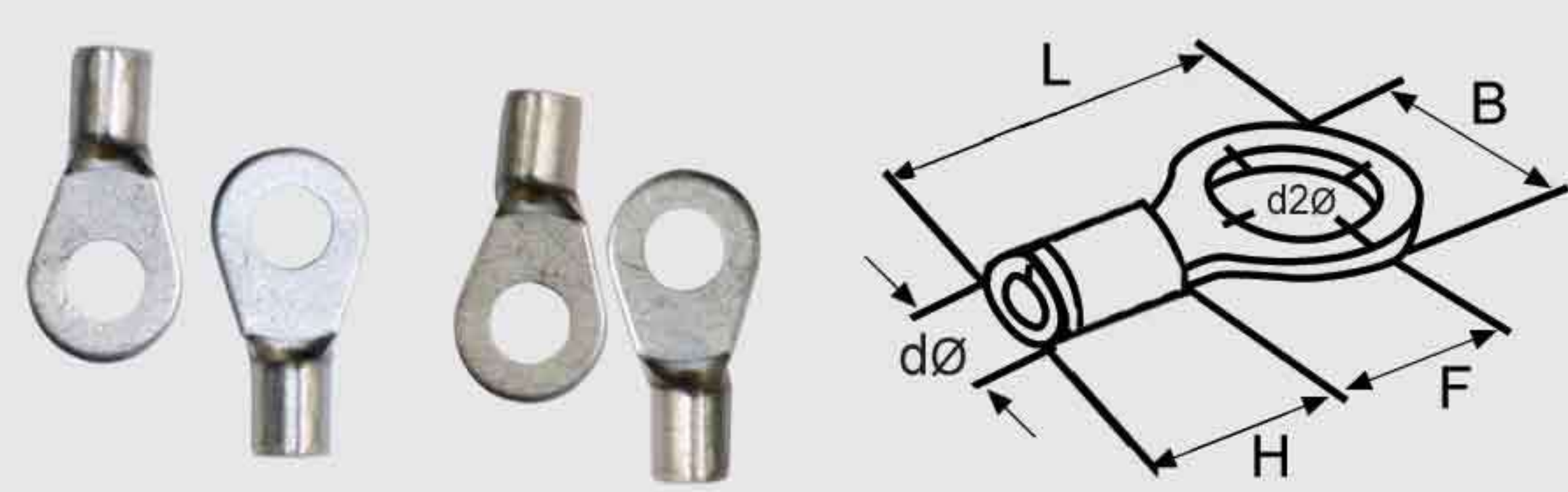
BRASS TINNED FEMALE CONNECTORS	Part #	H mm	B mm	L mm	F mm	D2Ø mm	DØ mm	A.W.G.	Packing
	DR41	5	8.0	16	11	4.3	1.6	22 - 16	25 Pcs
	DR42	5	8.0	16	11	4.3	2.4	16 - 14	25 Pcs

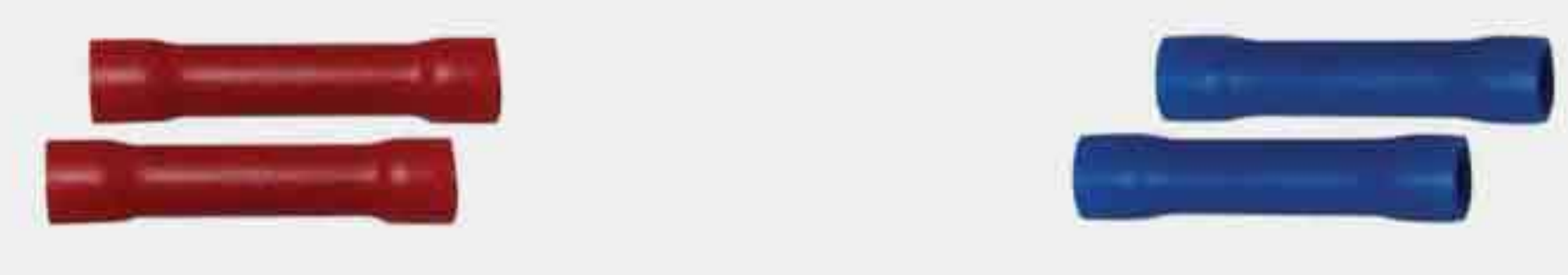
BUTT SPLICE WIRE CONNECTORS	Part #	Size	Color	A.W.G.	Packing
	BC2	Small	Red	22 - 16	25 Pcs
	BC3	Medium	Blue	16 - 14	25 Pcs

AUTOMATIC WIRE STRIPPER WITH 7" ADJUSTER	Part #	Peel Width
 <p>Wire Stripper is a handy invention for removing insulation from electrical wire. Jaws adjust automatically to wire size. Pincer pulls insulation off with one hand-squeeze. Lightweight and simple to us.</p>	CR3	5/8"

REPAIR KIT WITH PLASTIC CASE	Part #	Description
	EKIT1	Kit includes 25 pcs (ea.) of CE2, CE5, E1, E2, D28, D63, Y23, Y24, DR41, DR42 Connectors, Terminals plus one Wire Stripper

PLASTIC 40-COMPARTMENT ELECTRONIC COMPONENTS STORAGE BOX CASE (LARGE)	Part #	Description
	PB-40	11" Long 7" Wide 1-3/4" High 40 independent storage compartments

Superior Electric® presents a wide range of electrical switches to serve a variety of applications. These switches are designed to replace original brand name parts. Our prolific range offers switches of different amperage and voltage including trigger type, push button, ON/OFF toggle switches.



Function of Switches

Switches are one of the most commonly replaced parts in power tools. A switch handles all ON/OFF and variable speed functions. They also have a role in electric braking; they can momentarily reverse electrical polarity. Because switches use mechanical internals, they tend to degrade and wear out over time, eventually requiring replacement.

When is Replacement Required?

- Tool has completely stopped functioning and refuses to turn on.
- Tool operates intermittently, requiring multiple tries to turn on, until eventually it won't turn on at all.
- Variable speed function and electric braking aren't working properly.

Quality Build

All **Superior Electric®** switches are made of high quality plastic that can stand against the usual wear and tear of working environments for long periods negating the need for quick switch replacements.

Compatibility

Superior Electric® switches are a perfect replacement for many brand names including:



Standardized Safety – All **Superior Electric®** powertool electrical switches are UL approved. UL (Underwriters Laboratories) approved product means that UL has tested representative samples of the product and determined that it meets UL's requirements.



Part # Voltage Amperage



L17 125 V 12 A

ON-OFF

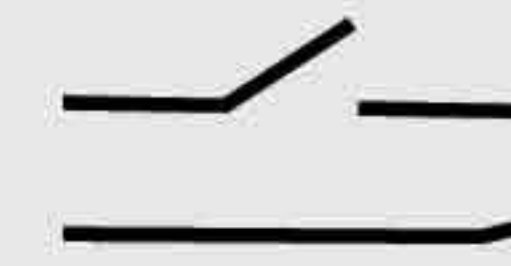

Sliding Trigger with lock. Used in power tools, hammers, circular saws, cutting machines etc.
Replaces Makita OE P/N 651232-8



L17-2 125 V 16 A

ON-OFF

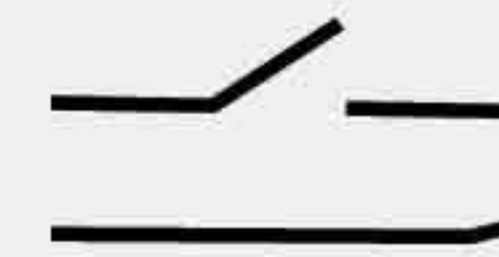

Sliding Trigger with lock. Used in power tools, hammers, circular saws, cutting machines etc.
Replaces Makita OE P/N 651297-0



L29 125 V 18 A

ON-OFF

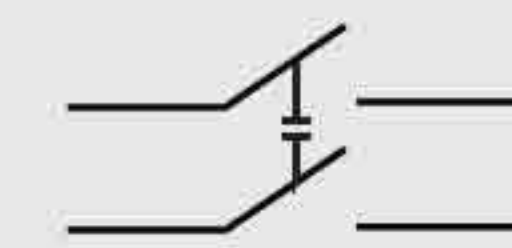

Grinder Switch. Used in grinders and sanders.
Replaces Makita 650101-0, 651176-2, 651177-0, 651143-7



Part #	Voltage	Amperage		
--------	---------	----------	--	--



L39 125/250 V 10/6 A

ON-OFF

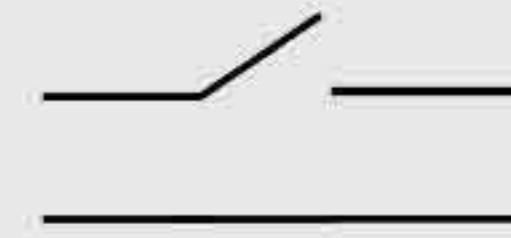

Push Button Switch. Used in portable power tools. angle grinders, die grinders etc.

Replaces: Makita OE P/N 651947-7
Bosch OE P/N 1607200146



L50 125/250 V 24/12 A

ON-OFF

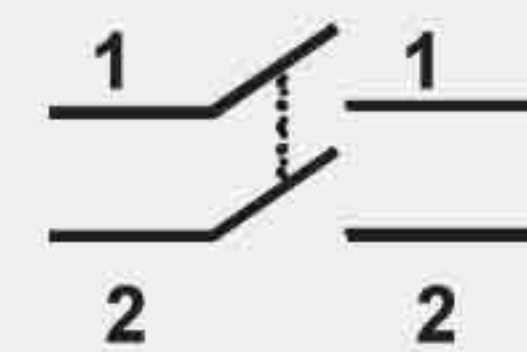

Trigger Switch Used in Makita Circular Saw
Replaces OE P/N Makita 651172-0,
651121-7 & 651168-1



L50-3 125/250 V 24/12 A

ON-OFF

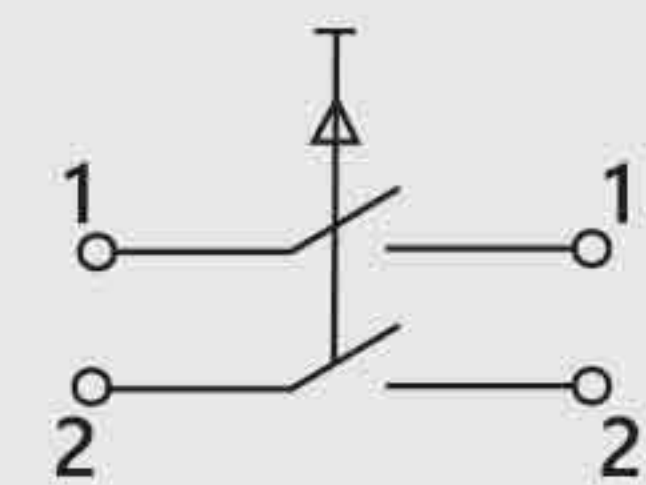

Trigger Switch Used in Makita Circular Saw
Replaces OE P/N Makita 651172-0,
651121-7 & 651168-1



Part # Voltage Amperage



SW7A
4 Prong

125/250 V 20/12 A

ON-OFF

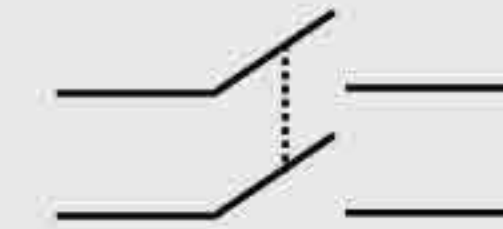

On - Off Toggle Switch is mainly used on table saws & numerous other bench top tools.
Replaces: Delta OE P/N 489105-00
Ridgid / Ryobi 46023



SW7B
2 Prong

125/250 V 20/12 A

ON-OFF

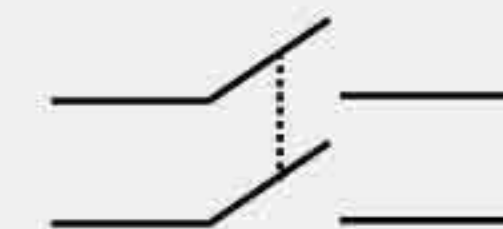

On - Off toggle switch. 2 terminals with optional pull-out lock pin. Used on table saws & numerous other bench top table saws
Switch OE P/N Delta, Black & Decker & Porter Cable 489105-00
Ridgid / Ryobi 46023
SW7-KEY OE P/N Delta, Black & Decker & Porter Cable 1343758



SW29E
4-Terminals

125/277 V 20/15 A

ON-OFF

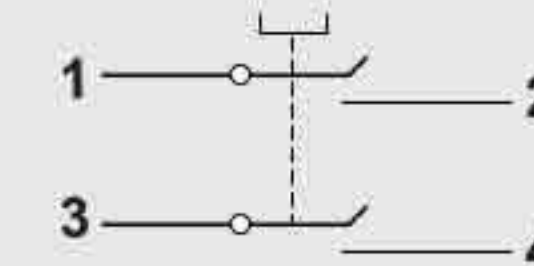

On - Off toggle switch. Comes with Rubber waterproof Cap/Boot. Used on Tile saws
OE P/N MK Diamond 154310, Hubbell HBL21SP,
Dewalt 5130221-00, Husqvarna 542193885,
Emglo 5131519-00



Part # Voltage Amperage



SW30E
6-Terminals 125/277 V 20/15 A

ON-OFF

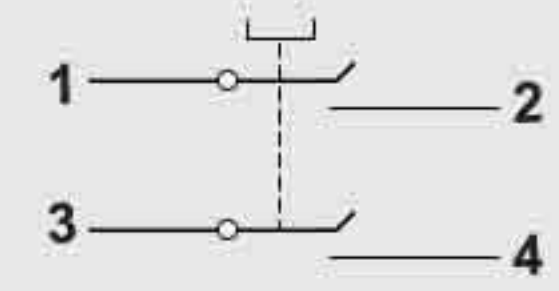

Aftermarket On-Off Toggle Switch
Replaces Ridgid 44905



SW38A 125/250 V 24/12 A

ON-OFF

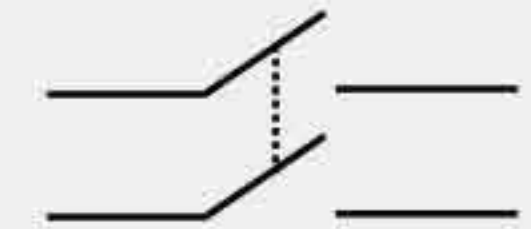

Trigger Switch with large button. Used on table saws and power tools with higher ratings, miter saws, chop saws etc.
OE P/N Variety



SW38C 125/250 V 24/12 A

ON-OFF

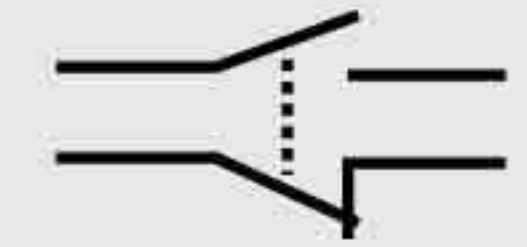

Over hang Trigger Switch with large button. Used on table saws and power tools with higher ratings, miter saws, chop saws, etc.
Replaces Dewalt OE P/N 391926-01



	Part #	Voltage	Amperage		
 <p>Aftermarket Trigger Switch - Tabled Connectors Reversed Terminals Replaces Dewalt OE P/N 391926-01 & 391926-00</p>	SW38C-R	125/250 V	20/12 A	ON-OFF	
 <p>Over hang Trigger Switch with large button. Used on table saws and power tools with higher ratings, miter saws, chop saws, etc. Replaces Dewalt OE P/N 153609-00</p>	SW38D	125/250 V	24/12 A	ON-OFF	
 <p>Aftermarket Trigger Switch Eaton Style Overhang Trigger Replaces Dewalt OE P/N 153609-00</p>	SW38D-3	125/250 V	24/12 A	ON-OFF	
 <p>Over Hang Trigger Switch without lock. Integrated dust proofing commonly used in bench tops and power tools. Replaces: Milwaukee OE P/N 14-78-0525</p>	SW54	125 V	10 A	ON-OFF	



Part #	Voltage	Amperage
--------	---------	----------



SW54L 125 V 10 A

ON-OFF

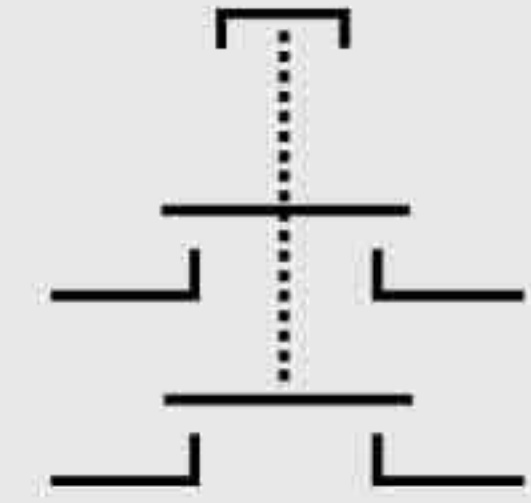

Over Hang Trigger Switch with lock.
Integrated dust proofing commonly used in bench tops and power tools.
Replaces: Milwaukee OE P/N 14-78-0550



Features
EMERGENCY STOP COVER

SW56
Single phase 120 V 35 A - 2 HP
Single phase 230 V 20 A - 3 HP

ON-OFF

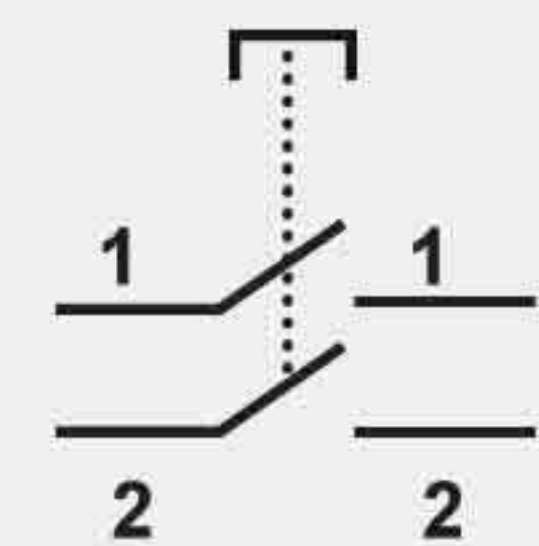

Large Table Saw Push-Button Switch.



Features
EMERGENCY STOP COVER

SW56-1
Single phase 125/250 V 35/20 A

ON-OFF

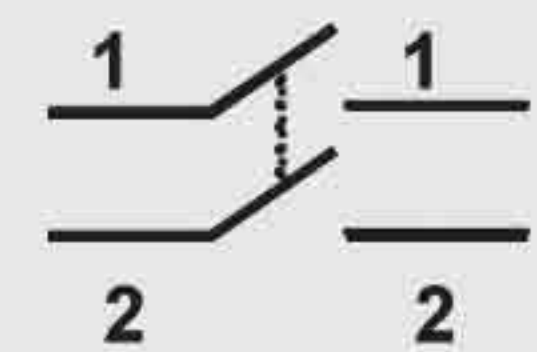

Large Table Saw Push Button Switch for Table Saws



Part # Voltage Amperage



SW57 120 V 16 A

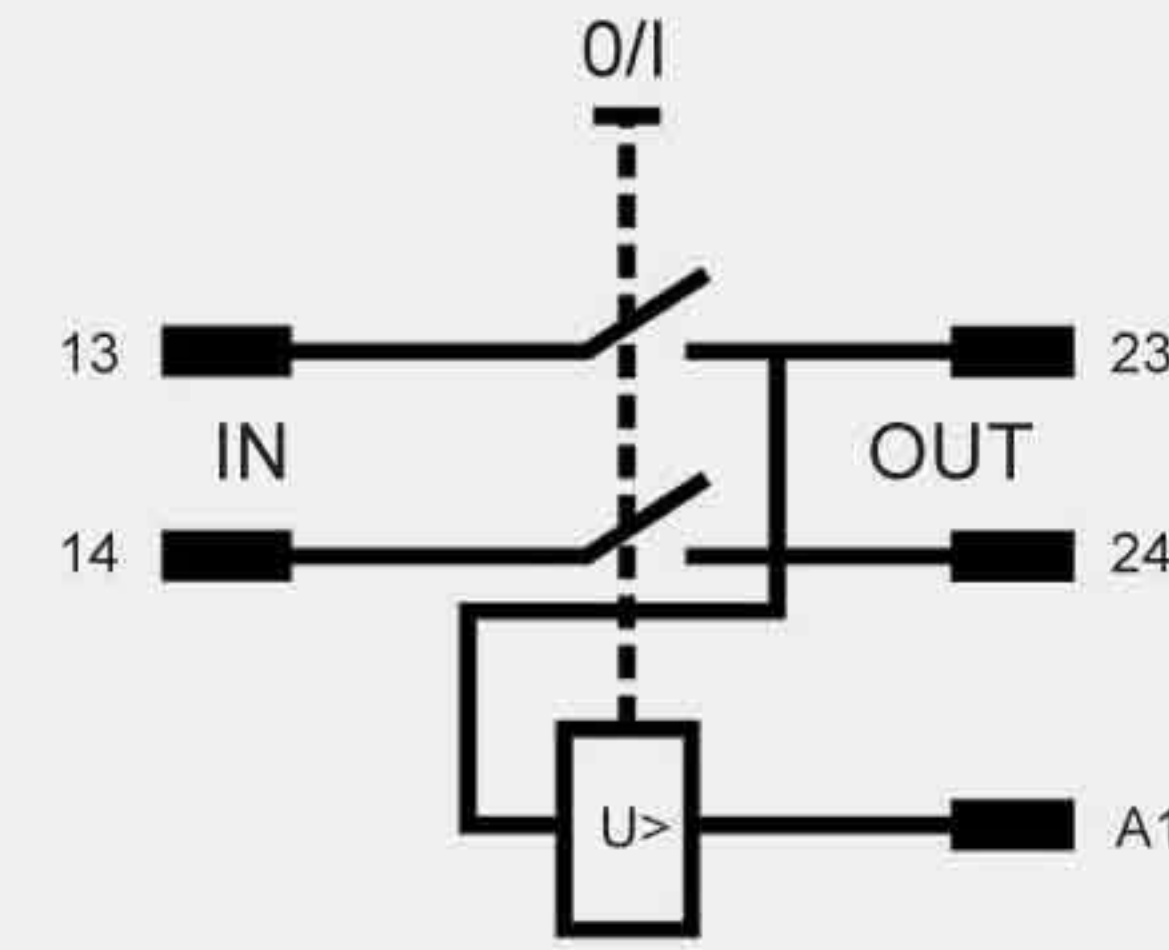

ON-OFF

Compatible with induction motors up to 1.1kW (1.5hp) and brush motors up to 1.9kW
Sports 4 terminal NVR switch
Mounting Size: 0.875" (7/8") x 1.875" (1-7/8")



SW66 125 V 18 A



ON-OFF

Grinder Switch. Used in Bosch grinders.
Replaces: Bosch OE P/N 1607200147



SW7C 125/250 V 24/12 A



ON-OFF

On/Off Toggle Switch (Optional Lock)



Part #	Voltage	Amperage
--------	---------	----------



SW77	125/250 V	15/10 A
------	-----------	---------

ON-OFF

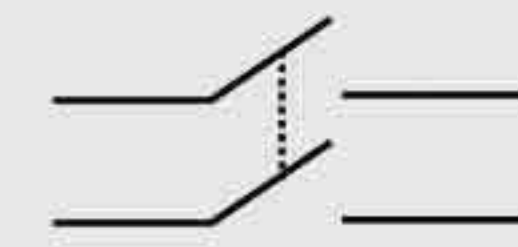

Trigger Switch. Mainly used on circular saws with high Amp rating.

Skil HD77 & HD77M, Worm Drive Skil Saws
Skil OE P/N 2610321608



SW77L	125/250 V	15/10 A
-------	-----------	---------

ON-OFF

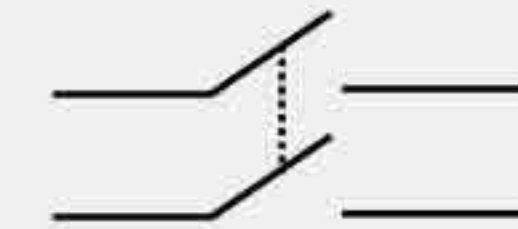

Trigger Switch with Lock. Mainly used on circular saws with high Amp rating.

Skil HD77 & HD77M, Worm Drive Skil Saws
Skil OE P/N 2610321608



SW77-20	125/250 V	20/10 A
---------	-----------	---------

ON-OFF

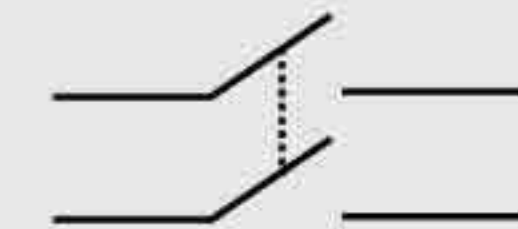

Trigger Switch. Mainly used on circular saws with high Amp rating.

Skil HD77 & HD77M, Worm Drive Skil Saws
Replaces Ryobi OE P/N 760245002
Skil OE P/N 2610321608



	Part #	Voltage	Amperage	
 <p>Hammer Switch. Used in Bosch rotary hammers. Replaces Bosch OE P/N 1617200109, 1617200091 & 1619P10396</p>	SW88	125 V	16 A	
 <p>Push Button Switch. Used in angle grinders, die grinders, etc. Replaces Milwaukee OE P/N 23-66-2665</p>	SW92	125 V	10 A	
 <p>Hammer Switch. Used in Bosch rotary hammers and demolition hammers. Replaces Bosch OE P/N 1617200048</p>	SW99	125 V	16 A	



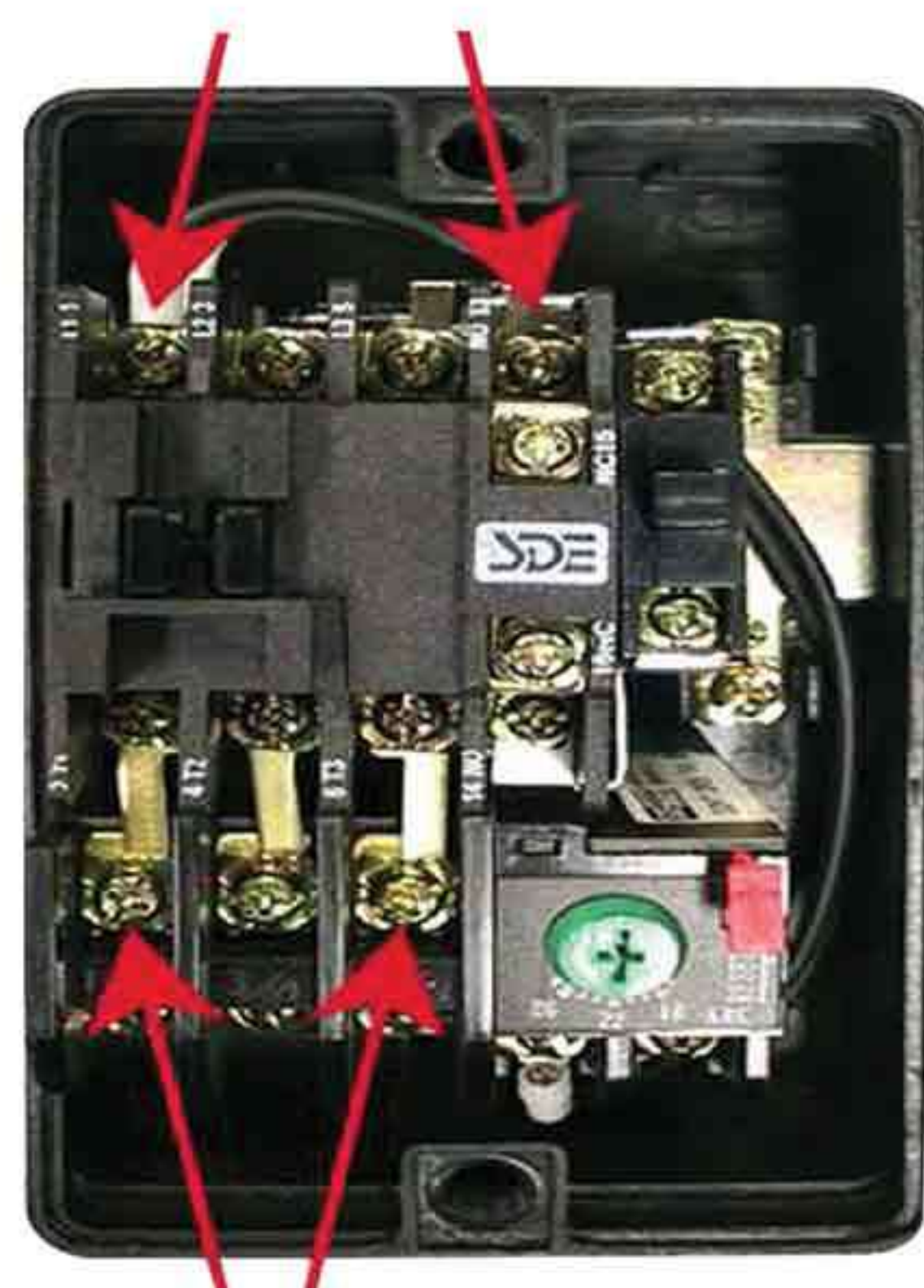

Motor Load

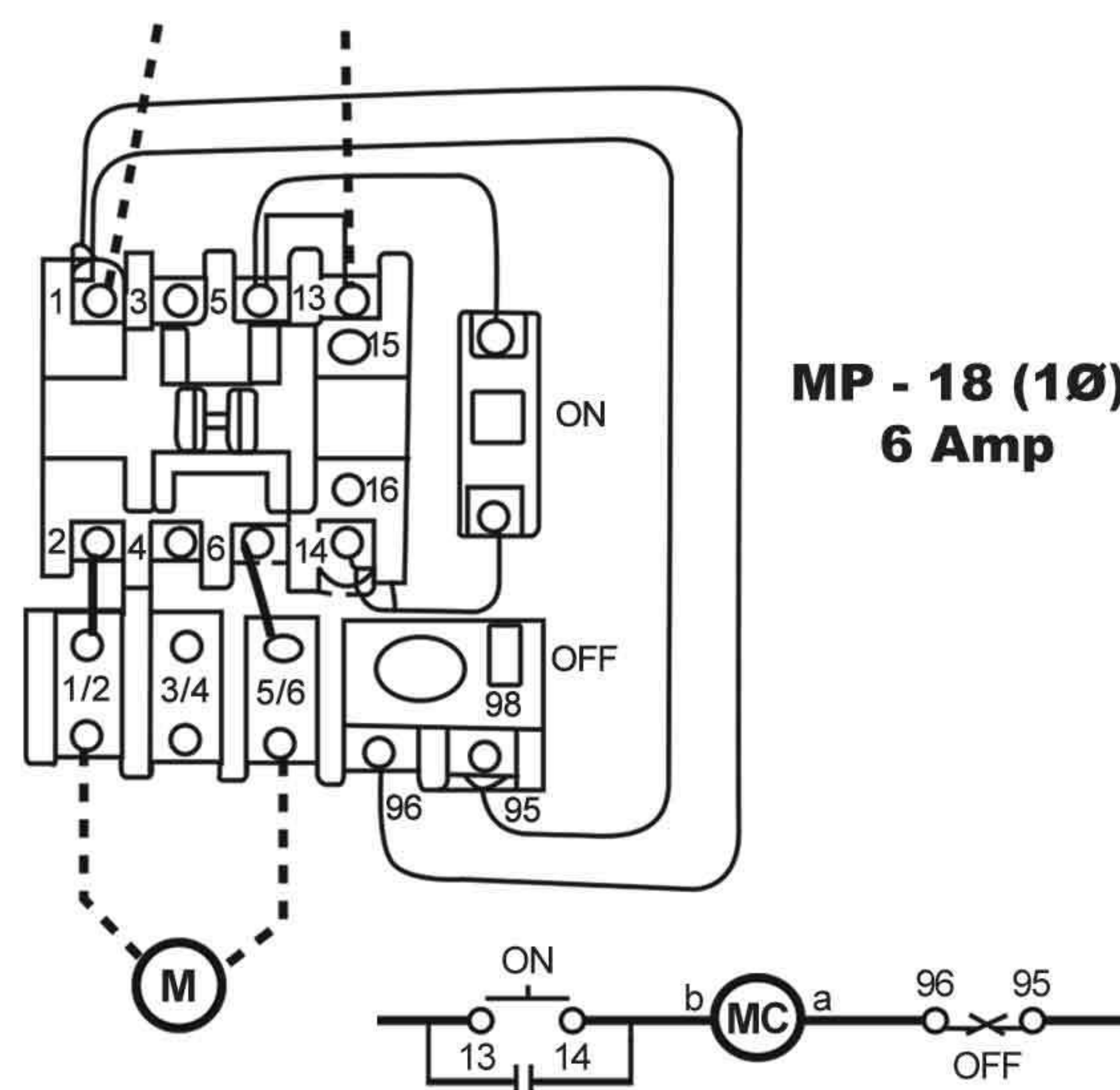

MP - 18 (1Ø)
6 Amp

Part #	Voltage	Amperage	Height	Width	Depth	Approval
SW90-23	1 PH - 220-240 V	3 HP - 18-26 A	6 1/2"	3 5/8"	4 1/2"	SP
SW90-25	1 PH - 220-240 V	5 HP - 22-34 A	7 5/8"	4 1/4"	4 1/2"	UL
SW90-33	3 PH - 220-240 V	3 HP - 8-12 A	6 1/2"	3 5/8"	4 1/2"	UL
SW90-35	3 PH - 220-240 V	5 HP - 12-18 A	6 1/2"	3 5/8"	4 1/2"	N/A
SW90-37	3 PH - 220-240 V	7.5 HP - 18-26 A	7 5/8"	4 1/4"	4 1/2"	SP
SW90-39	3 PH - 220-240 V	10 HP - 22-34 A	7 5/8"	1 1/4"	4 1/2"	UL



Push-Button Circuit Breaker
Thermal Overload Switch
Protector

Part # Voltage Amperage

SE17OLS	125/250 VAC	17 A
SE20OLS	125/250 VAC	20 A
SE30OLS	125/250 VAC	30 A

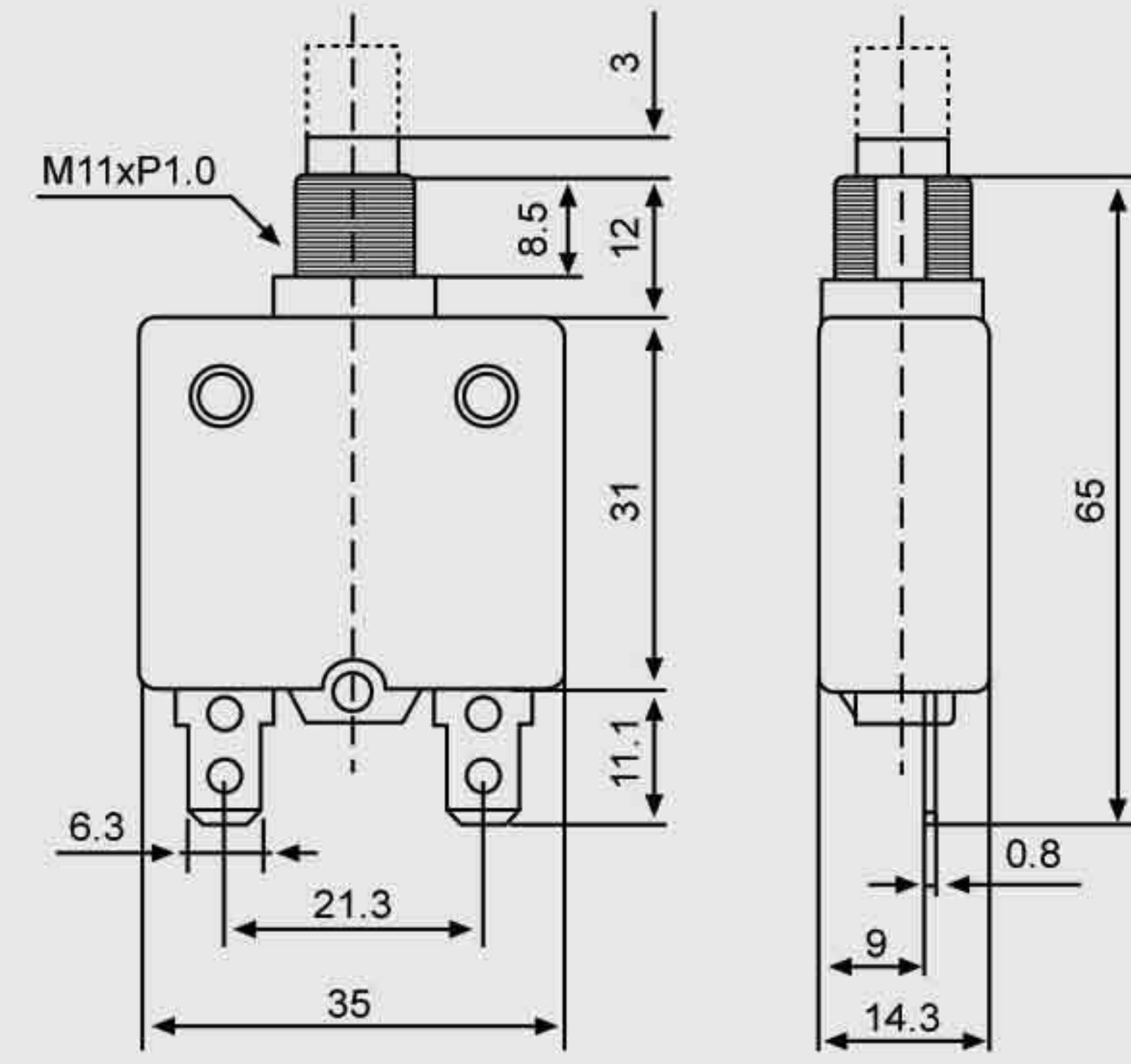

FOOT PEDAL ELECTRIC SWITCH

Part # Voltage Amperage Cord Length



SW85FP	110 V	15 A	6.5Ft.
---------------	-------	------	--------

Foot Pedal Router Switch

Features:

Superior Electric 110Volts / 15Amp Foot Pedal Router V Type Electric Switch. Let your feet control the power & free up your hands to focus on work. Spend more time woodworking & less time constantly fumbling for the power switch. Electric foot switch can be used with scroll saws, router tables, sanders or any power tool rated at a maximum of 15A. Tool plugs into foot switch & 6.5ft cord plugs into a grounded 115V outlet. Momentary snap-action design means that you press down with your foot to turn it on & then simply remove your foot to turn the foot switch off.

Specifications:

SPDT (Single pole, double throw)
Aluminum construction
Wire colors: White = Common, Black = N.C., Red = N.O



STARTING CAPACITORS

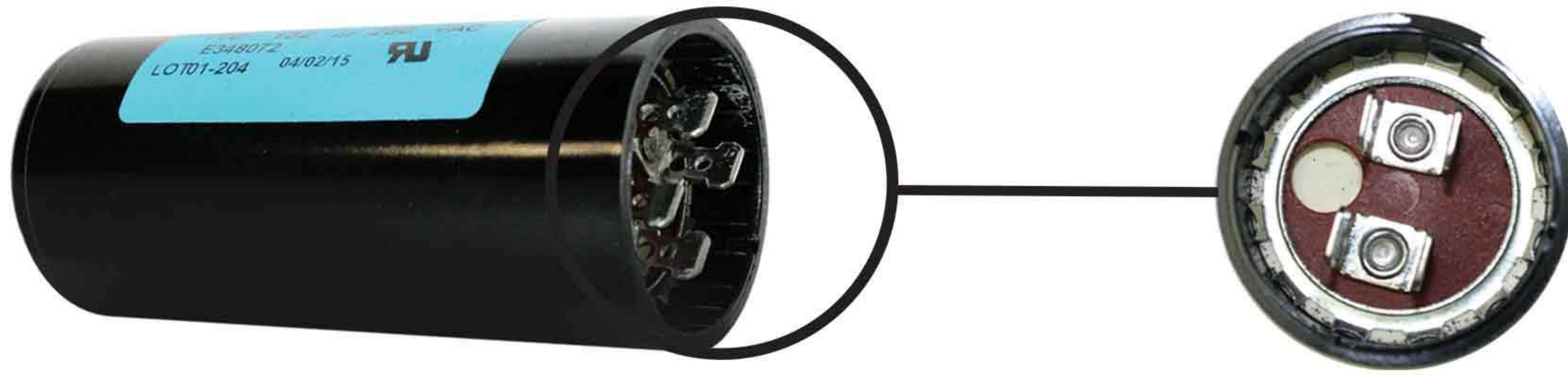

Part #	Size	Terminals	Shape / Case	Dia	Length
CMC7010	120-144 MFD +/-5% AC 250V	2	Round / Phenolic	1.4"	3.4"
CMC7011	100-120 MFD +/-5% AC 250V	2	Round / Phenolic	1.4"	3.4"
CMC7012	110-132 MFD +/-5% AC 250V	2	Round / Phenolic	1.4"	3.4"
CMC7013	60-72 MFD +/-5% AC 250V	2	Round / Phenolic	1.4"	3.4"
CMC7014	40-48 MFD +/-5% AC 360V	2	Round / Phenolic	1.4"	2.75"
CMC7015	100MFD +/-5% AC 300V	2	Round / Phenolic	1.90"	4.30"
CMC7016	120MFD +/-5% AC 300V	2	Round / Phenolic	1.90"	4.30"
CMC7017	MFD +/-5% AC 250/275V	2	Round / Phenolic	2"	4"
CMC7018	710-850 MFD +/-5% 50Hz/60Hz AC 125V	4	Round / Phenolic	1.88"	4.38"



RUNNING CAPACITORS



4 TERMINALS



2 TERMINALS

Part #	Size	Terminals	Shape / Case	Dia	Length
CMC7001	10MFD +/-5% AC 250V	4	Round / Phenolic	1.35"	2.85"
CMC7002	10MFD +/-5% AC 450V	4	Round / Phenolic	1.35"	3.25"
CMC7003	20MFD +/-5% AC 450V	2	Round / Phenolic	1.55"	3.20"
CMC7004	40MFD +/-5% AC 450V	2	Round / Phenolic	1.80"	3.70"
CMC7005	40MFD +/-5% AC 450V	2	Round / Phenolic	1.60"	2.90"
CMC7006	50MFD +/-5% AC 450V	2	Round / Phenolic	1.60"	3.90"
CMC7007	60MFD +/-5% AC 450V	2	Round / Phenolic	1.80"	3.90"



	Part #	Type	Port	Amperage	FPT	PSI
	LF10-1H	Bend Lever	Single	20A	1/4"	85 - 125
	LF10-1H-MP	Bend Lever	Single	20A	1/4"	95 - 125
	LF10-1H-HP	Bend Lever	Single	20A	1/4"	135 - 175
	LF10-4H	Bend Lever	Four	20A	1/4"	85 - 125
	LF10-4H-MP	Bend Lever	Four	20A	1/4"	95 - 125
	LF10-4H-HP	Bend Lever	Four	20A	1/4"	135 - 175
	LF10-L1H	Push/Pull Knob	Single	20A	1/4"	95 - 125
	LF10-L4H	Push/Pull Knob	Four	20A	1/4"	95 - 125
	LF17-1H	Internal	Single	24A	3/8"	145 - 175
	LF16-111	Adjustable Water Pressure Switch	Single	-	1/4"	30 - 50



WHY SUPERIOR ELECTRIC® CARBON PRODUCTS ARE BETTER?

Superior Electric® uses **Toyo Tanso®** carbon in its carbon products which, being isotropic graphite encapsulates enhanced stability and improved strength. **Toyo Tanso®** pioneered the development of isotropic graphite that features isotropic structure throughout and its enriched characteristics are achieved through Cold Isostatic Pressing (CIP) of micro particles.

Isotropic graphite is used in various industries including:

- Semiconductor manufacturing
- Renewable Energy Industry
- Mold industry
- Nuclear energy industry

All of the above industries require precision, advanced stability, reliability and strength. **Toyo Tanso®** carbon offers all these characteristics.

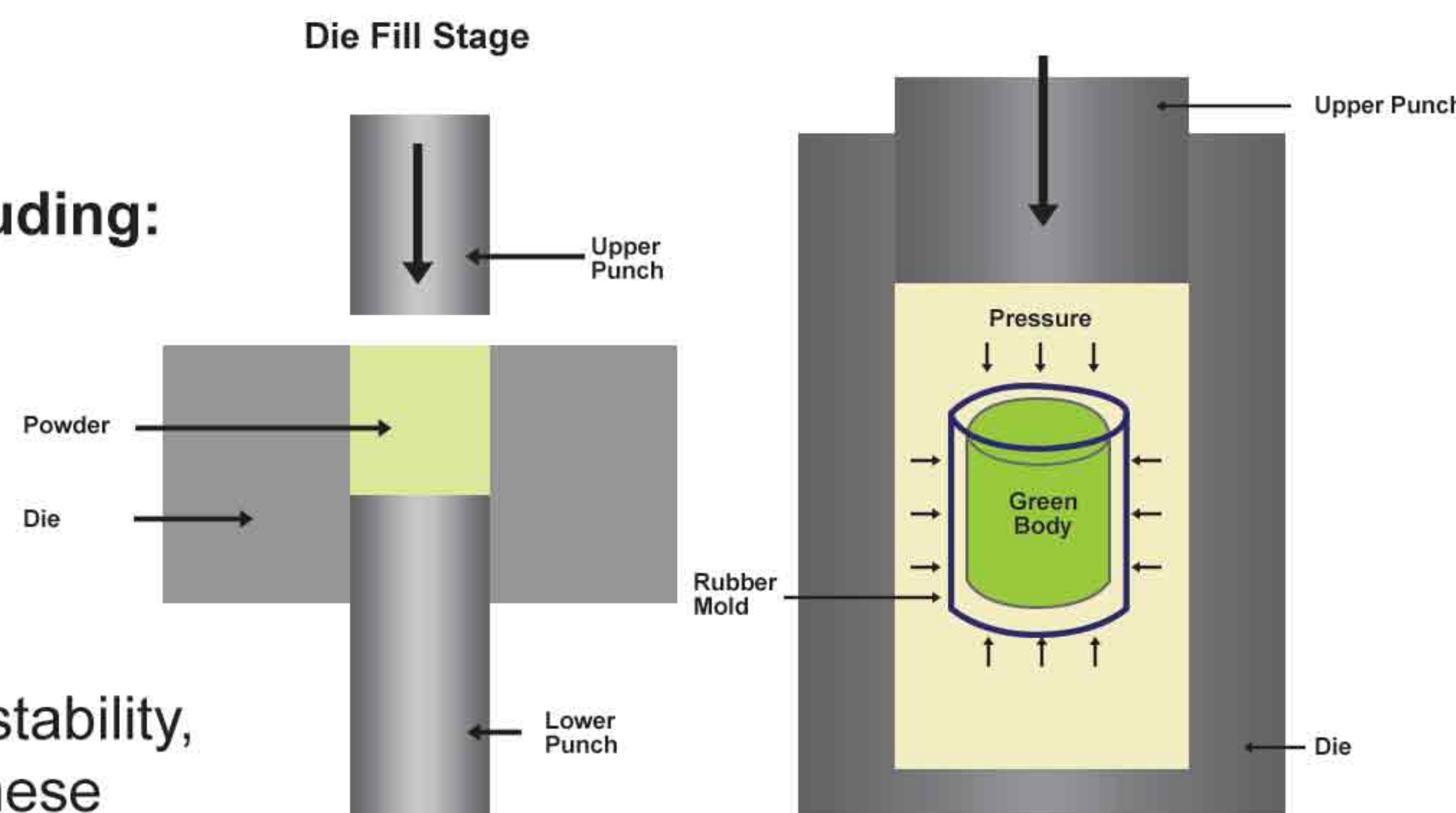

Cold Isostatic Pressing

LEADING FEATURES OF TOYO TANSO® CARBON

Isotropic Structure – Regular graphite has anisotropic patterns, which in simpler words means the properties of the material vary across a dimension making it unreliable. On the other hand, isotropic structure features uniform characteristics throughout a cross section.

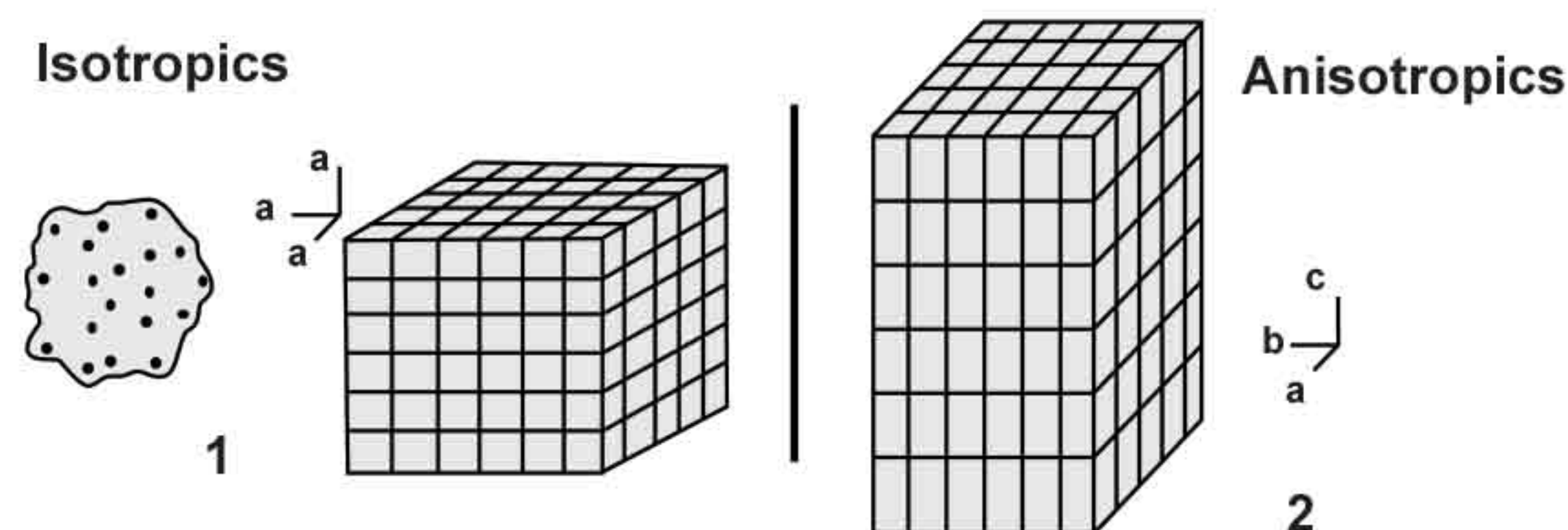

Improved Stability & Reliability – Because of the micro particle structure, **Toyo Tanso®** carbon offers a greater magnitude of strength and property variation across dimensions is negligible. Moreover, this carbon has a low coefficient of thermal expansion that means it maintains its original shape and characteristics in high temperature environments and excessive temperatures don't cause softening of material or melt downs.

Heat & Chemical Resistant – Low coefficient of thermal expansion also translates into better thermal shock resistance and heat distribution properties with minor heat deformation. That's why **Toyo Tanso®** carbon preserves its stability up to temperatures as high as 2000° C. In addition to excellent heat resistance, only few concentrated oxidizers can affect this material. For most part, **Toyo Tanso®** carbon is chemically stable and can be used as a non-corroding substitute of metal.

Enhanced Electrical Conductivity – Exceptional heat resistance allows for improved electrical conductivity and makes this material an ideal product for a range of electronics such as heaters.

Abrasion Resistant – Layered crystalline structure of **Toyo Tanso®** carbon means it has low coefficient of friction and self lubrication properties which lead to a highly corrosion and abrasion resistant material. It also results in low friction under electrical conduction which is crucial for carbon brushes.

Light and Easy to Machine - Compared to metals, the bulk density of **Toyo Tanso®** carbon is low allowing for a lightweight design. Moreover, it features exceptional mechanical machining properties facilitating accurate shaping processes. These characteristics have enabled **Toyo Tanso®** to develop innovative and superior technology for carbon brush applications.

Superior Ridability in Sliding Contact - Compared to conductive metals in general, bulk density and the Young's modulus have considerably low magnitudes in carbon; hence carbon has superior ridability during sliding contact.

CARBON BRUSHES

All Carbon Brushes use Japanese Toyo Tanso® material & sold as a pair of 2pcs/pack

	Part #	Size (L x W x H)	Manufacturer OE Part#
 	D04	0.67" x 0.66" x 0.27"	Ridgid 0502025007 Dewalt 614367-00, 5140024-30
 	G58	0.51" x 0.31" x 0.24"	Dewalt, Black & Decker & Porter Cable 176846-02, 176846-03 & 176846-04
 	K21 K42	0.73" x 0.52" x 0.25"	Makita CB154, 194986-9, 181047-4, 643152-0, 643153-8, 957805410 and 643154-6
	K24	0.57" x 0.39" x 0.23"	Makita 191945-4, 643100-9, 643103-3, 643101-7, 194982-7 & CB-124
	K25	0.47" x 0.35" x 0.23"	Makita 191938-1, 195008-8, 643408-1 & CB-408
	K27	0.54" x 0.31" x 0.19"	Makita 191912-9, 191947-0, 643072-8, 643053-2, 643052-4 & CB-76
	K28	0.53" x 0.31" x 0.19"	Makita 191956-9, 194971-2, 643066-3, 643054-0, 643056-6, 643057-4 & CB-75
	K29	0.62" x 0.70" x 0.27"	Makita 191953-5, 191957-7, 643200-5 & CB-203
	K30	0.65" x 0.43" x 0.20"	Makita 195001-2, 194074-2 & CB325
	K32	0.62" x 0.70" x 0.27"	Makita 191953-5, 194991-6, 643200-5 & CB203

CARBON BRUSHES

All Carbon Brushes use Japanese Toyo Tanso® material & sold as a pair of 2pcs/pack

	Part #	Size (L x W x H)	Manufacturer OE Part#
	K33	0.63" x 0.70" x 0.27"	Makita 191957-7, 194992-4, 191944-6 & CB204
<p>Made in Spain</p>  <p>German Carbon</p>	K33A with auto-cut off	0.62" x 0.7" x 0.27"	Makita CB-204 & 191957-7
	K34	0.70" x 0.52" x 0.25"	Makita 181048-2, 194987-7, 643155-4 & CB155 Ridgid 301036001
	K36	0.52" x 0.40" x 0.12"	Makita 194159-4, 194427-5, 195021-6 & CB440
	K38	0.44" x 0.35" x 0.23"	Makita 195007-0, 191927-6, 191962-4, CB-419 & CB407
	K40	0.66" x 0.43" x 0.20"	Makita 191963-2, 194996-6, & CB303
	K41	0.62" x 0.42" x 0.19"	Makita 191974-7, 191978-9, 195396-3, CB-318, CB336 & CB340
	K44	0.37" x 0.31" x 0.25"	Makita CB430, 191964-0, 195018-5 & 191971-3
	K45	1.06" x 0.51" x 0.24"	Makita CB175, CB171, CB-171, 194990-8 and 194412-8
	K46	1" x 1" x 1"	Makita CB350, CB351, 197244-2, CB-350 and 194160-9
	K47	1" x 1" x 1"	Makita CB-105, 643105-9 and 181038-5



CARBON BRUSHES

All Carbon Brushes use Japanese Toyo Tanso® material & sold as a pair of 2pcs/pack

	Part #	Size (L x W x H)	Manufacturer OE Part#
 	M11	0.56" x 0.41" x 0.27"	Dewalt 450374-00, 450374-12 & 450374-99
	M18	0.52" x 0.27" x 0.23"	Dewalt 445861-25
	M34	0.81" x 0.50" x 0.25"	Dewalt 145323-02, 145323-03 & 145323-06
	M35	0.85" x 0.48" x 0.25"	Dewalt 381028-02 & 381028-08
	M65	0.50" x 0.39" x 0.24"	Dewalt 650916-01, 636128-01
	M66	0.52" x 0.23" x 0.26"	Dewalt 445861-18, 445861-20
	M67	0.48" x 0.24" x 0.24"	Dewalt N031636 & Porter Cable 888386, 888028
	M68	0.41" x 0.27" x 0.54"	Dewalt N398321, N088403
	M69	0.91" x 0.48" x 0.36"	Dewalt 131602-00
	M70	0.66" x 0.27" x 0.66"	Dewalt 5140024-30, 614367-00

CARBON BRUSHES

All Carbon Brushes use Japanese Toyo Tanso® material & sold as a pair of 2pcs/pack

	Part #	Size (L x W x H)	Manufacturer OE Part#
 <p>Made in Spain</p>  <p>German Carbon</p>	M71	0.52" x 0.27" x 0.23"	Dewalt 445861-12
<p>Made in Spain</p>  <p>German Carbon</p>	M72 with auto-cut off	1.02" x 0.62" x 0.24"	Dewalt 585041-00
<p>Made in Spain</p>  <p>German Carbon</p>	M73 with auto-cut off	0.52" x 0.39" x 0.25"	Dewalt 636128-03
	M74	0.6" x 0.25" x 0.3"	Dewalt 650917-01
	M75	0.63" x 0.70" x 0.27"	Dewalt 617848-05
	M76	0.62" x 0.30" x 0.24"	Dewalt N097696
	M77	0.98" x 0.23" x 0.23"	Dewalt & Porter Cable N119739, 879058
	M78	0.20" x 0.27" x 0.68"	Dewalt N292059
	M79	0.75" x 0.50" x 0.25"	Dewalt N434649, N400577 & 654631-01
	M81	0.75" x 0.53" x 0.25"	DeWalt 5140033-19
	M82	0.75" x 0.47" x 0.25"	Dewalt OE # N257540

CARBON BRUSHES

All Carbon Brushes use Japanese Toyo Tanso® material & sold as a pair of 2pcs/pack

	Part #	Size (L x W x H)	Manufacturer OE Part#
	N08	0.52" x 0.43" x 0.24"	Milwaukee 22-18-0670
	N09	0.65" x 0.43" x 0.24"	Milwaukee 22-18-0620 & 22-18-0680
	N10	0.31" x 0.24" x 0.47"	Milwaukee 22-18-0910
	N11	0.62" x 0.42" x 0.19"	Milwaukee 22-16-0250, 22-16-0270 & 22-16-0275
	N22	0.15" x 0.25" x 0.44"	Milwaukee 22-20-1010, 22-20-0290 & 22-20-0555
	N30	2.5" x 1.5" x 1.5"	Milwaukee 22-22-1630
	N39	0.56" x 0.43" x 0.25"	Milwaukee 22-18-0780
	N40	0.54" x 0.31" x 0.24"	Milwaukee 22-18-0710

CARBON BRUSHES

All Carbon Brushes use Japanese Toyo Tanso® material & sold as a pair of 2pcs/pack

	Part #	Size (L x W x H)	Manufacturer OE Part#
 	P05	0.66" x 0.43" x 0.27"	Metabo HPT 999-043 & Dewalt 514003-43
	P06	0.66" x 0.66" x 0.27"	Metabo HPT 999-044
	P07	0.67" x 0.27" x 0.43"	Metabo HPT 981-612Z & 999-073
	P08	0.65" x 0.25" x 0.35"	Metabo HPT 999-088
	P09	0.66" x 0.66" x 0.27"	Metabo HPT 999-074 & 937943Z
 	R02	0.74" x 0.43" x 0.20"	Porter Cable N031635, 883191
	R03	0.75" x 0.42" x 0.25"	Porter Cable 802173
	R04	0.74" x 0.42" x 0.25"	Porter Cable N031652, 869659, 824216
	R05	0.75" x 0.43" x 0.24"	Porter Cable N030459
	R06	0.78" x 0.43" x 0.24"	Porter Cable 879553
	R07	0.99" x 0.50" x 0.31"	Porter Cable N031634 & 698873
	R08	0.25" x 0.25" x 0.41"	Porter Cable 876345

CARBON BRUSHES

All Carbon Brushes use Japanese Toyo Tanso® material & sold as a pair of 2pcs/pack

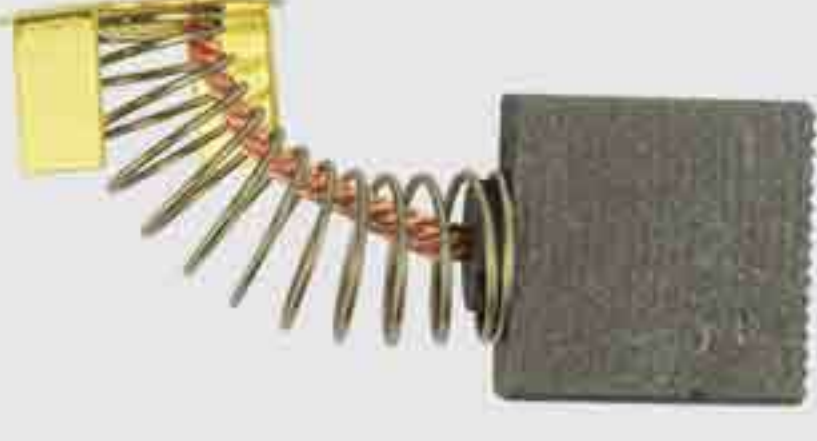
	Part #	Size (L x W x H)	Manufacturer OE Part#
 	R09	0.49" x 0.24" x 0.76"	Porter Cable 878266 & 5140096-08
	R12	0.51" x 0.24" x 0.24"	Porter Cable 690741
 	R700	0.62" x 0.24" x 0.66"	Ridgid 44815
 	R701	Need Dimension	Ryobi OE 6540063
  	S71	0.75" x 0.31" x 0.20"	Replaces Bosch OE # 1617000525
	S72	0.72" x 0.39" x 0.24"	Replaces Bosch OE # 1607000V61
	S77	0.72" x 0.50" x 0.25"	Skil 1619X01351, Bosch 2610320391 & 2610912980
	S77-56	--	Carbon Brush Holder Replaces Skil OE # 1619X04708, 1619X01267, 2610329940
	S77-CAP	--	Carbon Brush Cap For Skil Saw Replaces Skil 1619X01268, 3603463500 & Ridgid 512010001
	S79	0.67" x 0.67" x 0.27"	Bosch 2610997207, 2610915758 & 2610993222
	S80	0.65" x 0.39" x 0.19"	Bosch 1607014138, 1607014172 & 1607014176 Metabo 316046800, 316034930, 316041640 & 34301172











CARBON BRUSHES

All Carbon Brushes use Japanese Toyo Tanso® material & sold as a pair of 2pcs/pack

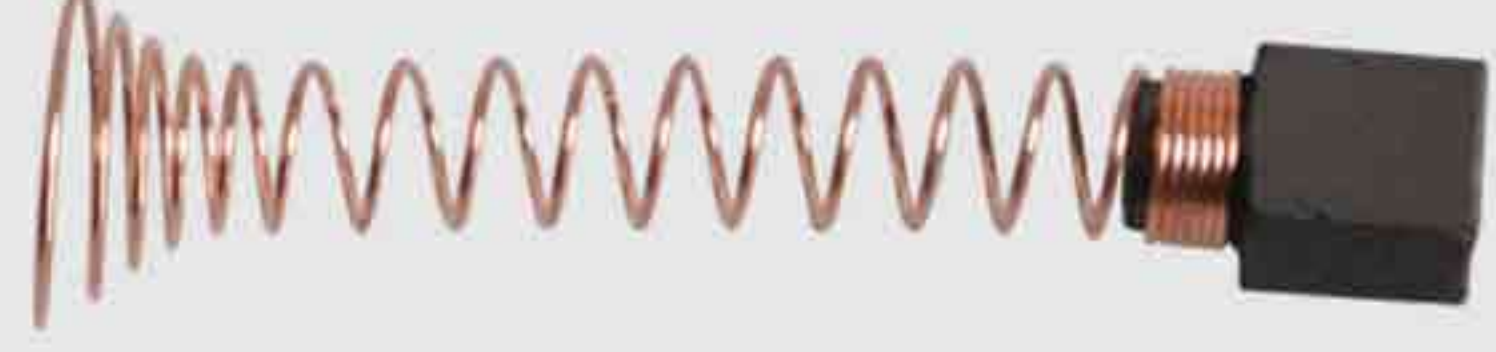
	Part #	Size (L x W x H)	Manufacturer OE Part#
	S81	0.62" x 0.24" x 1.03"	Bosch 1617014126
	S82	0.48" x 0.24" x 0.90"	Bosch 1617014144
<p>Made in Spain</p>  <p>German Carbon</p>	S83 with auto-cut off	0.86" x 0.63" x 0.24"	Bosch 1607014171
	S84	0.63" x 0.24" x 0.90"	Bosch 2609199169
	S85	0.63" x 0.24" x 0.90"	Bosch 1607014178 & 1607014175
<p>Made in Spain</p>  <p>German Carbon</p>	S85A with auto-cut off	0.88" x 0.63" x 0.24"	Bosch 1607014175
<p>Made in Spain</p>  <p>German Carbon</p>	S87 with auto-cut off	0.68" x 0.31" x 0.19"	Bosch 1607014116
<p>Made in Spain</p>  <p>German Carbon</p>	S88 with auto-cut off	0.52" x 0.31" x 0.25"	Bosch 1619P02870
<p>Made in Spain</p>  <p>German Carbon</p>	S89 with auto-cut off	1.03" x 0.62" x 0.25"	Bosch 1617014143
	S90	0.63" x 0.38" x 0.19"	Bosch 3607014011

CARBON BRUSHES

All Carbon Brushes use Japanese Toyo Tanso® material & sold as a pair of 2pcs/pack

	Part #	Size (L x W x H)	Manufacturer OE Part#
  <p>Made in Spain German Carbon</p>	S91	0.60" x 0.31" x 0.19"	Bosch 2604321905 & 3607014006
	S92	0.27" x 0.24" x 0.17"	Bosch 2610005646
	S93	0.42" x 0.24" x 0.17"	Bosch 2615090935 Dremel 90935
	S94	0.23" x 0.20" x 0.18"	Bosch 261590930C Dremel 90930-05
	S95	0.63" x 0.24" x 0.90"	Bosch 1617000425
 <p>Made in Spain German Carbon</p>	S95A with auto-cut off	0.87" x 0.63" x 0.24"	Bosch 1617000425
	S96	0.81" x 0.48" x 0.24"	Bosch 1619X08020, 1619X07410, 1619X01351, 2610320391
	S97	0.72" x 0.32" x 0.20"	Bosch 1607014116
	S100	0.55" x 0.38" x 0.25"	Skil 23973 & Bosch 2610023973
 <p>M35 Carbon Brush SW38D Switch</p>	DW708-KIT	--	Dewalt DW708

CARBON BRUSHES

Superior Electric® replacement ball bearings are premium quality bearings that are designed to replace a wide range of genuine brand name bearings. **Superior Electric**® bearings can be used in multitude of machines for a variety of applications.

Function of Ball Bearings

Ball bearings are used to reduce friction between rotating parts. The balls or rollers take the load and spin, distributing the weight evenly while the minimal contact area of the ball reduces friction. This reduces wear on the tool and allows it to run smoothly. Bearings experience constant wear when the tool is in operation from pressure, heat, vibration and friction. Because of this, many bearings need periodic maintenance or replacement.



Alloy Steel Construction

All **Superior Electric**® ball bearings are made of high quality alloy steel (E51100 100Cr6) so they can fare better in demanding applications. The steel used for **Superior Electric**® bearings has better yield and tensile strength than low quality alternatives to give them exceptional ruggedness.

Performance

Superior Electric® bearings can support torques up to as high as 4000 rotations per minute and are engineered for ABEC-3 Class 3 performance.

Because of high quality materials **Superior Electric**® ball bearings can last up to 3 years depending on the usage.

Compatibility

Superior Electric® ball bearings are a perfect replacement for many brand names including:



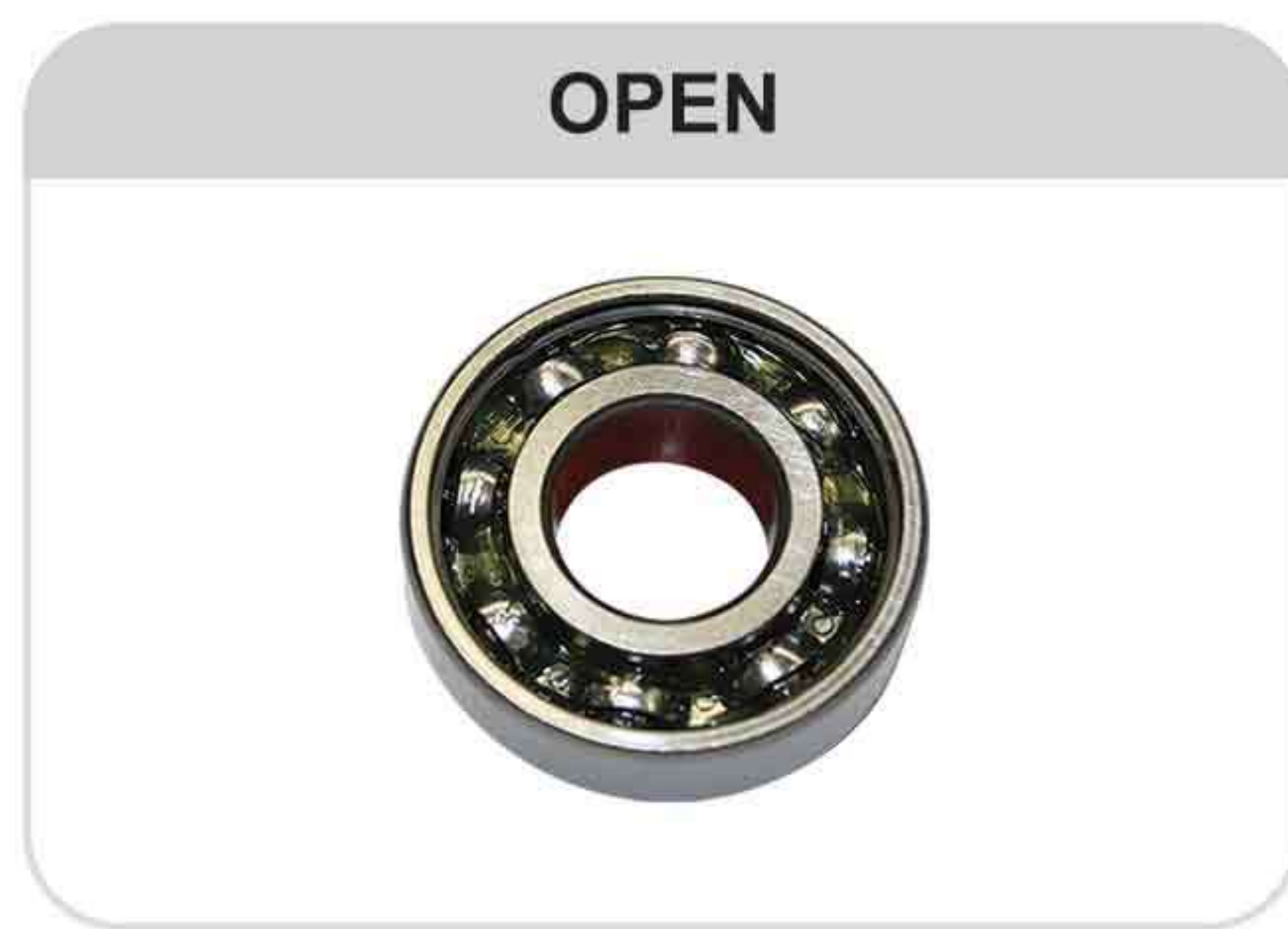

Part #	Side1/2	ID mm	OD mm	Width mm	Pack	Compatible to these OE Part#
SE 607-2RS	Seal/Seal	7	19	6	2pc/Pack	Bosch: 2600905032 Dewalt: 573119-02, 605040-02
SE 608-ZZ	Shield/Shield	8	22	7	2pc/Pack	Milwaukee: 02-04-0820, 02-04-0845, 02-04-0850, 02-04-0852 02-04-0854 Makita: 211031-6, 211033-2 , 211032-4 Bosch: 2610017348, 3600905513, 2610001147, 1600905032, 1619P01511 Delta: 1346630 Dewalt: 330003-60, 855284 Porter Cable: 843002 Metabo: 143115180
SE 609-ZZ	Shield/Shield	9	24	7	2pc/Pack	Various Applications
SE 626-RS	Seal/Open	6	19	6	2pc/Pack	Various Applications
SE 626-ZZ	Shield/Shield	6	19	6	2pc/Pack	Various Applications
SE 627-ZZ	Shield/Shield	7	22	7	2pc/Pack	Makita: 211028-5
SE 628-ZZ	Shield/Shield	8	24	8	2pc/Pack	Various Applications
SE 629-2RS	Seal/Seal	9	26	8	2pc/Pack	Bosch: 2610996949 Delta: 803854SV Makita: 211058-6, 210042-8, 211092-6
SE 629-ZZ	Shield/Shield	9	26	8	2pc/Pack	Bosch: 2610996949
SE 635-2RS	Seal/Seal	5	19	6	2pc/Pack	Various Applications
SE 635-ZZ	Shield/Shield	5	19	6	2pc/Pack	Various Applications
SE 6000-2RS	Seal/Seal	10	26	8	2pc/Pack	Bosch: 1900905173 Porter Cable: 893212 Milwaukee: 02-04-1020 Makita: 211061-7
SE 6000-RS	Seal/Open	10	26	8	2pc/Pack	Milwaukee: 02-04-1005

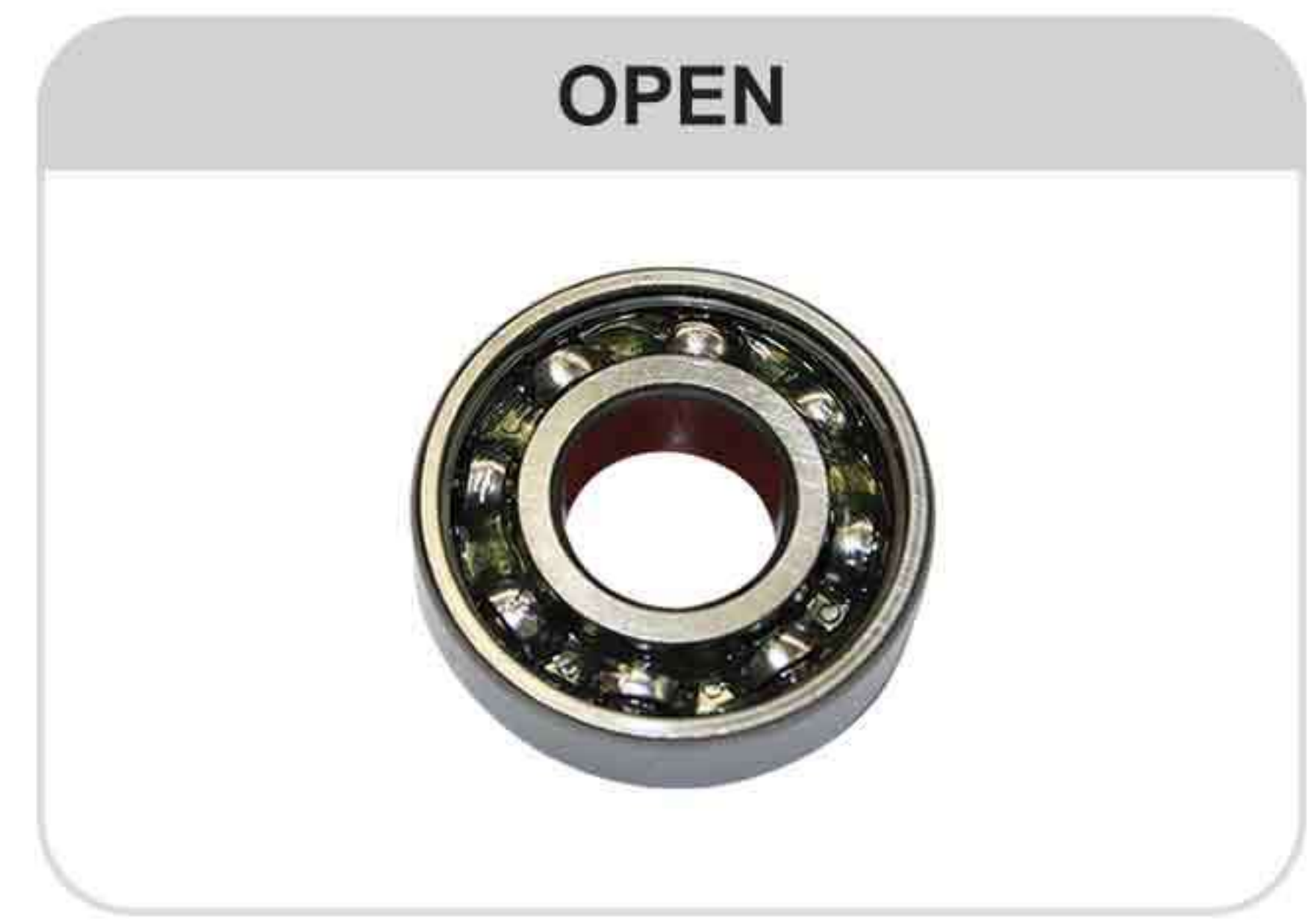

Part #	Side1/2	ID mm	OD mm	Width mm	Compatible to these OE Part#
SE 6000-ZZ	Shield/Shield	10	26	8	Porter Cable: 893212 Milwaukee: 02-04-1020 Makita: 211062-5 Dewalt: 5140086-56 Metabo: 143112150
SE 6001-ZZ	Shield/Shield	12	28	8	Bosch: 1900905161, 330003-09, 2610911985 Dewalt: 330003-64 Makita: 211142-7 Milwaukee: 02-04-1201
SE 6002-RS	Seal/Open	15	32	9	Milwaukee: 02-04-1510 Bosch: 2610911927, 2610997210, 2609110435, 1900905159
SE 6002-ZZ	Shield/Shield	15	32	9	Milwaukee: 02-04-1510 Bosch: 2610911927, 2610997210, 2609110435, 2600905034 Makita: 211236-8 Metabo: 143112030
SE 6003-RS	Seal/Open	17	35	10	Various Applications
SE 6003-ZZ	Shield/Shield	17	35	10	Various Applications
SE 6004-ZZ	Shield/Shield	20	42	12	Delta: 1313116
SE 6200-RS	Seal/Open	10	30	9	Porter Cable: 804218SV, 893207, 803876SV Milwaukee: 02-04-1041, 02-04-1030 Bosch: 2610004595, 2610017875 Makita: 211068-3 Dewalt: 5140101-94
SE 6200-ZZ	Shield/Shield	10	30	9	Porter Cable: 804218SV, 893207, 803876SV Milwaukee: 02-04-1041, 02-04-1030 Bosch: 2610004595, 2610017875, 2610909310, 1900905276, 2610911928 Dewalt: 5140101-94 Delta: 912535, 9200205352S Makita: 211066-7
SE 6201-RS	Seal/Open	12	32	10	Milwaukee: 02-04-1205, 02-04-1229 Bosch: 2610921080 2610017349 1610905028
SE 6201-ZZ	Shield/Shield	12	32	10	Milwaukee: 02-04-1205, 02-04-1229 Bosch: 2610921080, 2610017349, 2610000166 Makita: 211129-9 Delta: 920040116611 Porter Cable: 802311 Powermatic: BB-6201VV



Part #	Side1/2	ID mm	OD mm	Width mm	Compatible to these OE Part#
SE 6202-2RS	Seal/Seal	15	35	11	Metabo HPT: 620-2VV Dewalt: 330003-75, 605040-27, 330003-13 Porter Cable: 878064SV, 865119SV Bosch: 2610911986 Makita: 211206-7
SE 6202-RS	Seal/Open	15	35	11	Metabo HPT: 620-2VV Dewalt: 330003-75, 605040-27, 330003-13 Porter Cable: 878064SV 865119SV
SE 6202-ZZ	Shield/Shield	15	35	11	Metabo HPT: 620-2VV Dewalt: 330003-75, 605040-27, 330003-13 Porter Cable: 878064SV, 865119SV Makita: 211206-7
SE 6203-RS	Seal/Open	17	40	12	Makita 211256-2 Bosch 2610024748 Delta 1086894S
SE 6203-2RS	Seal/Seal	17	40	12	Makita: 211256-2 Bosch: 2610024748 Delta: 1086894S
SE 6300-ZZ	Shield/Shield	10	35	11	Various Applications
SE 6301-RS	Seal/Open	12	37	12	Bosch: 1610900015
SE 6301-ZZ	Shield/Shield	12	37	12	Bosch: 1610900015 Makita: 211132-0
SE 6302-ZZ	Shield/Shield	15	42	13	Dewalt / Porter Cable N127530
SE 6201-13-RS	Seal/Seal	13	32	10	Porter Cable 802311
SE 6202-16MM	Seal/Seal	16	35	11	Porter Cable 865119SV
SE 6203-LU	Seal/Seal	15	42	13	Dewalt / Porter Cable: N127530

Technical Specifications:

- Axial Load: 0.9 KN
- RPM: ≤ 4000
- Tolerance: ABEC-3 Class 3
- Material: E51100, 100Cr6
- Bearing Life: 3 Years (varies with application)



Part#
WP1000
120V Submersible Tile Saw
Water Pump - 260 Gallons/hr
 Voltage: 110-120V - 60 Hz
 Power: 15 Watts
 Max. Flow Rate: 260 Gallons/hr (1000 L/h)
 Max. Lift Height: 65"
 Cord Length: 5.5'
 Plug Type: 3 Prong (with ground) NEMA 5-15P
 Dimensions: 2-1/2"(W) x 3-1/4"(H) x 3-3/4"(L)



Part#
WP700
120V Electric Water Pump (Jebao JP900)
 Max. Head: 45"
 Max. Flow Rate: 145 Gal/Hr
 Cord Length: 6 feet
 No of Prong Plug: 3 (with ground)
 Dimensions: 1-7/8"(W) x 2-1/4"(H) x 2-3/4"(L)
 UL Approved: Yes
 Item No: JP900
 Manufacturer: Jebao Co. Ltd.



Part#
HD-700
12V Motor Oil Diesel Extractor
 Motor: 12V D.C.
 Power Draw: Approx 100W 8A
 Sound Level: 70 dB(A)
 Diesel Fuel/Heating Oil Flow Rate: 150 L/H
 Motor Oil (40-60 degrees) Flow Rate: 1l/min
 Color: Black + Yellow
 Extractor Pump Size: 6-1/8" x 5-1/4" x 4" (L x W x H)
 Inlet Hose: Approx 4 feet (L), 1/4" (diameter)
 Outlet Hose: Approx 5 feet (L), 1/2" (diameter)

Replacement Router Collets for Dewalt, Porter Cable, Bosch and Hitachi



RC025DW
1/4" Router Collet Replaces Dewalt 326286-04,
Bosch 2610906283 & Metabo HPT 323-293



RC025PC
1/4" Router Collet Replaces Porter Cable 42999



RC050DW
1/2" Router Collet Replaces Metabo HPT 325-199,
Dewalt 326286-03 & Bosch 2610906284



RC050PC
1/2" Router Collet Replaces Porter Cable 42950

Router Template Guides

Part#:	SE 3024	SE 3027	SE 3033	SE 3036	SE 3042	SE 3045	SE 3054
I.D.	21/32"	11/32"	13/32"	9/32"	5/8"	17/32"	1/4"
O.D.	3/4"	7/16"	1/2"	3/8"	54/64"	5/8"	5/16"
							

SE 3237
Brass Router Template Guide Lock Nut

Features:
Knurled surface for easy tightening
Compatible with all template guides
Precision Machined Brass for positive locking and durability



SE 3002
Brass Router Template Guide Kit

Includes: Part# SE 3045, SE 3237

Features:
I.D. 17/32" - O.D. 5/8"
Knurled surface for easy tightening
Compatible with all template guides
Comes in Carded Display Pack



SP 321492-3
Template Guide Adapter



Boot C

Cord Protector Strain Relief Rubber Boot fits 18/2 AWG Electrical Cords



EC182

9 Feet 18 AWG SJO 2 Wire 125 Volt NEMA 1-15P Electrical Cord

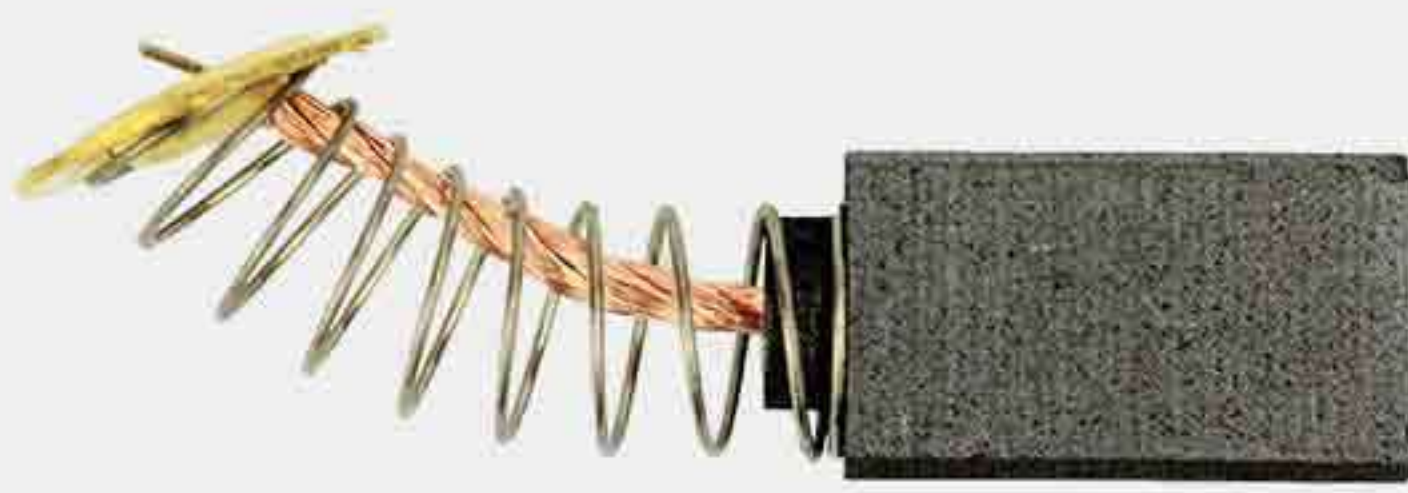

K27

Japanese Carbon Brush Set Replaces Makita (CB-76), 191947-0, 191912-9, 643052-4, 643072-8 & 643053-2 (2/pack)



L17

Aftermarket Trigger Type Switch Replaces Makita 651232-8



SE 225007-7

Replacement Belt for Makita 1900B Planer Replaces OEM Part # 225007-7



SE 608ZZ-D

Replacement Ball Bearing - 2 x Shield, ID 8 mm x OD 22 mm x W 7 mm
Makita 211031-6 Delta 1346630, Dewalt 330003-60, Porter Cable 843002, Metabo 143115180, Bosch 2610017348, Milwaukee 02-04-0820 (2pcs/pk)

SE 627ZZ-D

Replacement Ball Bearing - 2 x Shield, ID 7 mm x OD 22 mm x W 7 mm
Dewalt / Porter Cable N127530, Makita 2110284 (2pcs/pk)

SE 6000ZZ-D

Replacement Ball Bearing - 2 x Shield, ID 10 mm x OD 26 mm x W 8 mm
Porter Cable 893212, Makita 211062-5, Metabo 143112150, Dewalt 5140086-56, Milwaukee 02-04-1020 (2pcs/pk)



SE 6000-2RS-D

Replacement Ball Bearing - 2 x Seal, ID 10 mm x OD 26 mm x W 8 mm
Bosch 1900905173, Porter Cable 893212, Milwaukee 02-04-1020, Makita 211061-7 (2pcs/pk)

Superior Electric® offers a wide collection of light duty, medium duty and heavy duty service qualities of drill chucks. We offer both keyed and keyless chucks featuring 3/8", 1/2" and 5/8" sizes with 3/8-20, 3/8-24 and 1/2-20 UNF mounting threads. These drill chucks are designed and engineered to perfection so they can perform in challenging and demanding tasks without showing a slight weakness. Solid construction also allows the chucks to go through the day to day rigors of a tough job site and confront the usual wear and tear maintaining the quality and performance over long time.

Superior Electric® also offers a full line of chuck keys to fit almost all types of popular keyed chucks. Additionally we have a rubber chuck key holder to keep your chuck key tied to the tool's electrical cord.

Exceptional Build Quality – One of the most crucial aspects of a drill chuck is its ability to withstand high torques and for that it needs impressive build quality with sturdy materials. All **Superior Electric®** drill chucks feature alloy steel or polycarbonate construction that can hold up well against usual wear and tear and excessive torques.

Heavy Duty Performers – Because of robust construction, all **Superior Electric®** heavy duty drill chucks can perform heavy duty drilling tasks with ease. It doesn't matter if you're drilling into wood or concrete, you will always find these drill chucks up to the task.

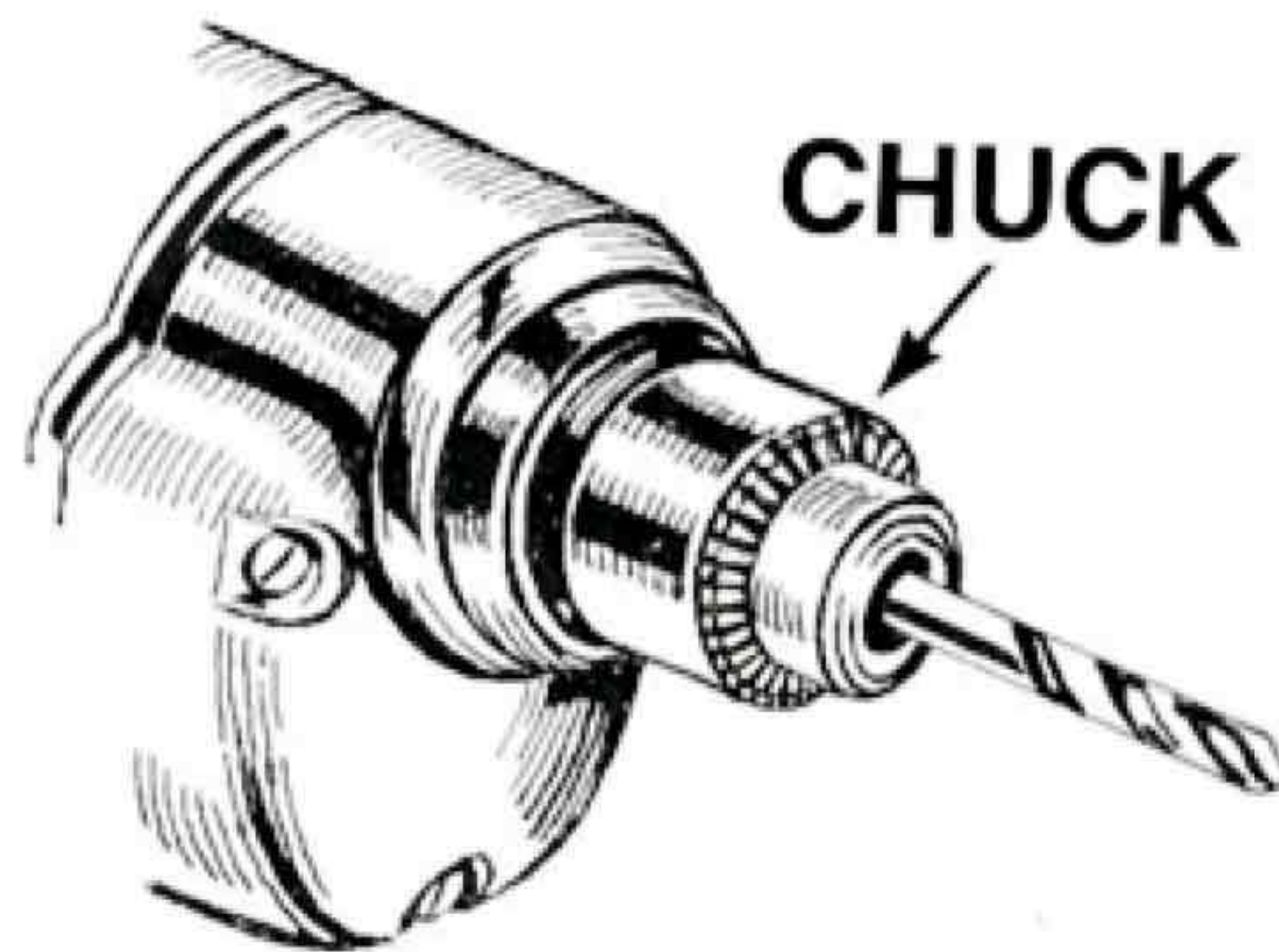

DRILL CHUCKS

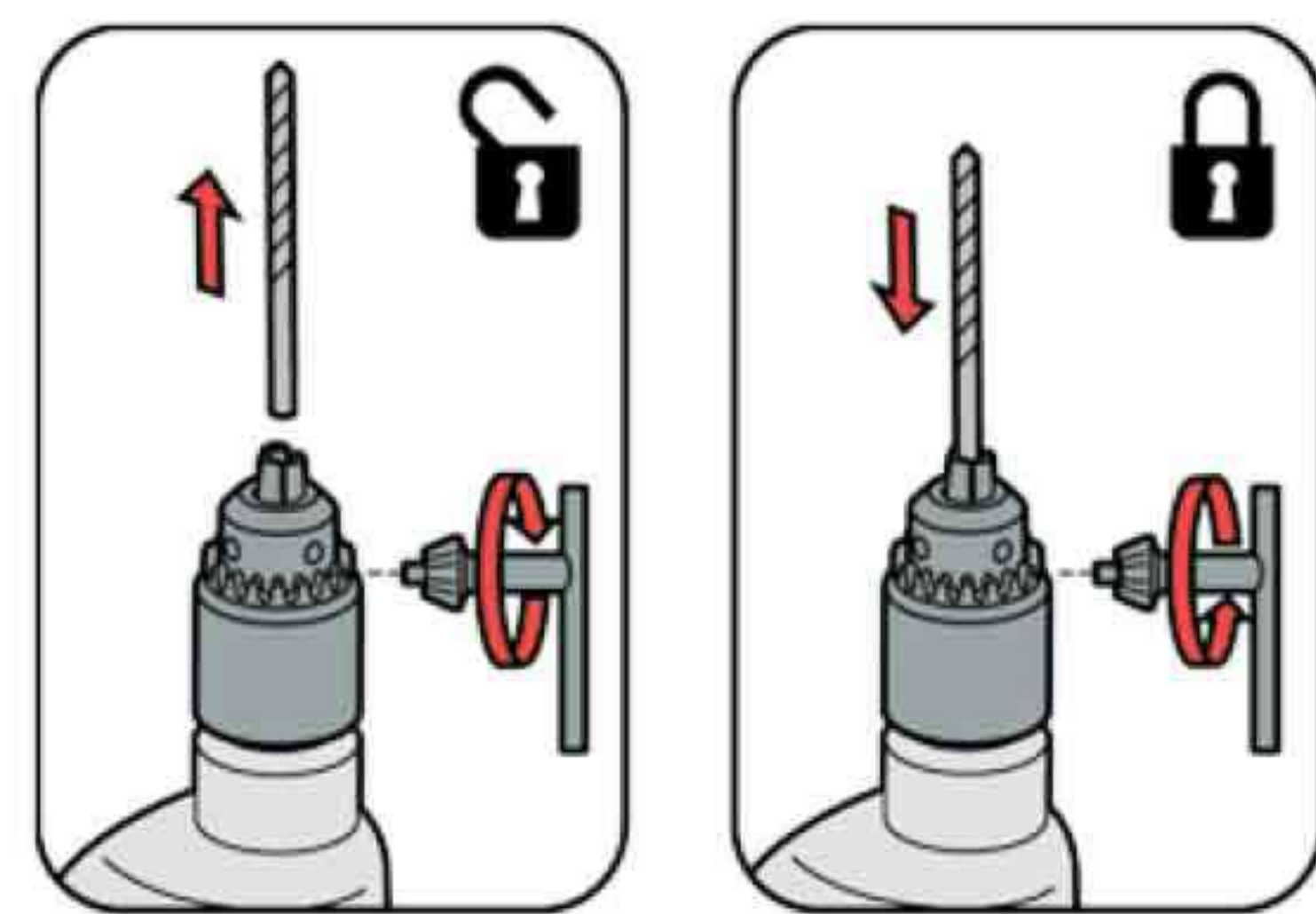

Keyed versus Keyless Chucks

Our product range includes both keyed and keyless varieties to address the needs of every consumer. Keyless chucks are more convenient for quick swapping of drill bits but keyed chucks have better high torque tolerance.

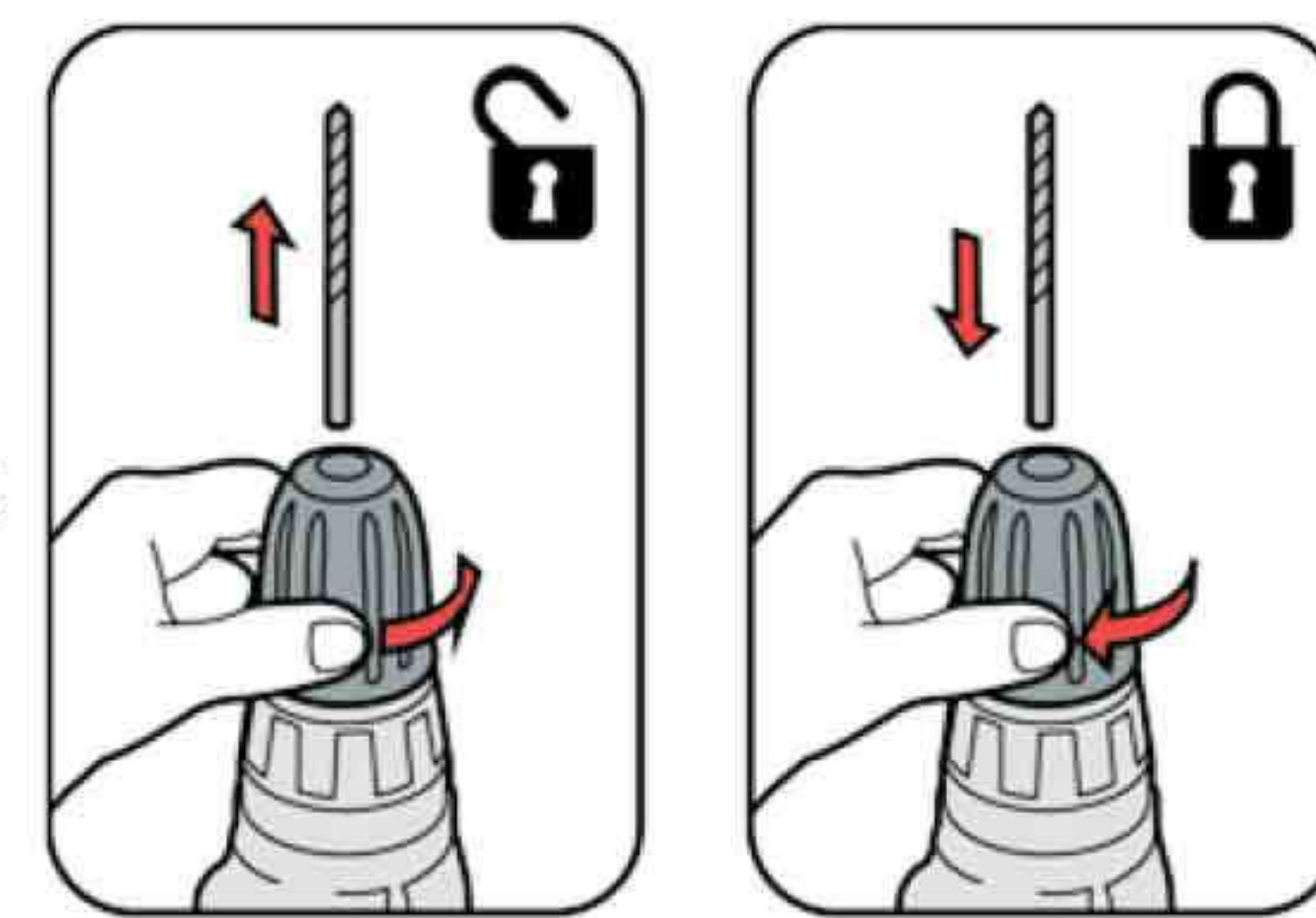

Corrosion Resistant – All alloy steel chucks feature a corrosion resistant finish to keep the chuck from deteriorating in quality over time.

Compatibility – **Superior Electric®** drill chucks are compatible with many brand name drills including Makita, Porter Cable, Milwaukee, DeWalt, Bosch and more.



	Part #	Max. Capacity	Min. Capacity	Mount	Runout	Sleeve Diameter
	J356A	1/4"	0.02"	3/8"-24 UNF	0.009"	1.2"
	J3513A	1/2"	0.06"	3/8"-24 UNF	0.013"	1.7"
	J3513B	1/2"	0.06"	1/2"-20 UNF	0.013"	1.7"
	J3713A	1/2"	0.06"	1/2"-20 UNF	0.013"	1.7"
	J3113	1/2"	0.08"	1/2"-20 UNF	0.013"	1.8"
	J3113HH	1/2"	0.08"	5/8"-16 UNF	0.007"	1.8"
	J3113-3	3/8"	0.04"	3/8"-24 UNF	0.007"	1.5"
	J3516A	5/8"	0.12"	1/2"-20 UNF	0.013"	1.95"

DRILL CHUCKS

KEYED DRILL CHUCKS



DRILL CHUCKS

	Part #	Max. Capacity	Min. Capacity	Mount	Runout	Sleeve Diameter
	J2210C-JT2	3/8"	0.04"	JT2	0.007"	1.7"
	J2213C-JT33	1/2"	0.04"	JT33	0.007"	2.1"
	J2213C-JT6	1/2"	0.04"	JT6	0.007"	2.1"
	J2220C-JT4	3/4"	0.12"	JT4	0.007"	2.5"
	J2316C-JT3	5/8"	0.12"	JT3	0.007"	2"



	Part #	Max. Capacity	Min. Capacity	Mount	Runout	Sleeve Diameter
	J0310	3/8"	0.04"	3/8"-24 UNF	0.009"	1.7"
	J0313	1/2"	0.04"	1/2"-20 UNF	0.009"	1.7"
	J1510T	3/8"	0.03"	3/8"-24 UNF	0.013"	1.7"
	J1713M	1/2"	0.08"	1/2"-20 UNF	0.013"	1.7"
	RV12M02	1/2"	0.06"	1/2"-20 UNF	0.013"	1.7"
	RV12M03	1/2"	0.06"	1/2"-20 UNF	0.013"	1.7"
	RV13M02	1/2"	0.06"	1/2"-20 UNF	0.013"	1.7"
	RV13M02-D with Clam Shell Pack	1/2"	0.06"	1/2"-20 UNF	0.013"	1.7"











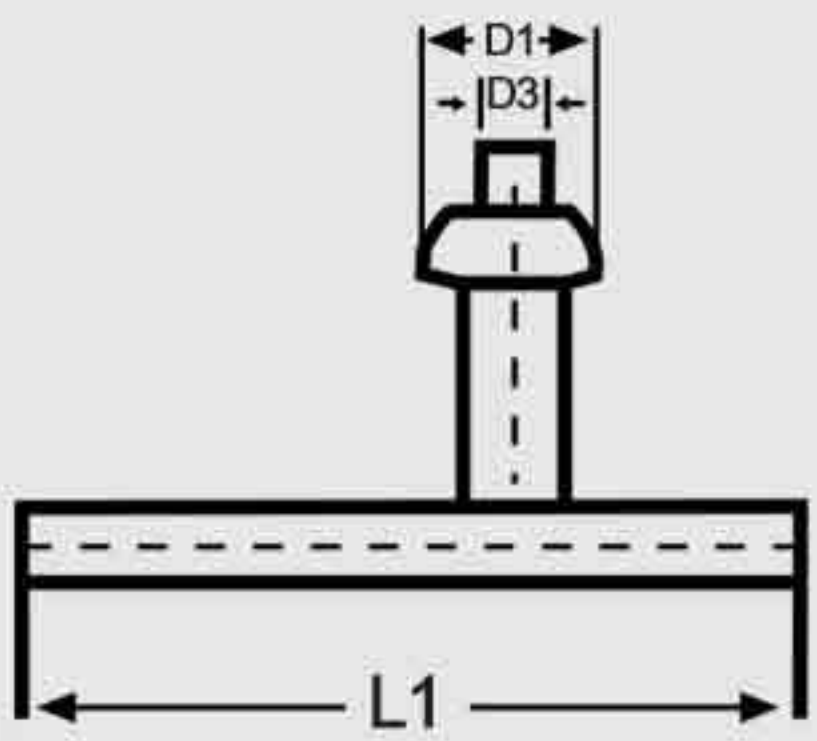

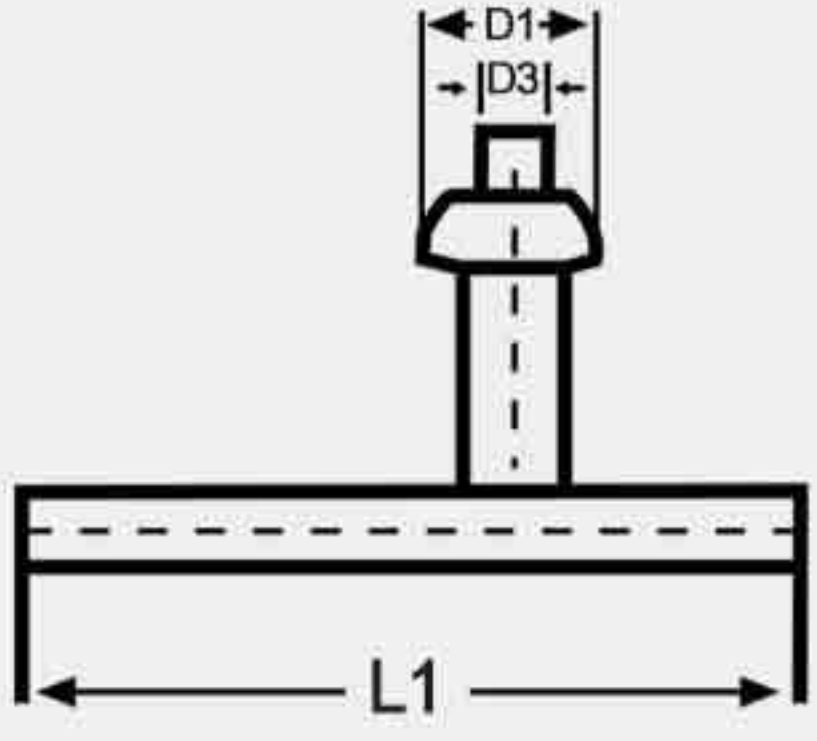

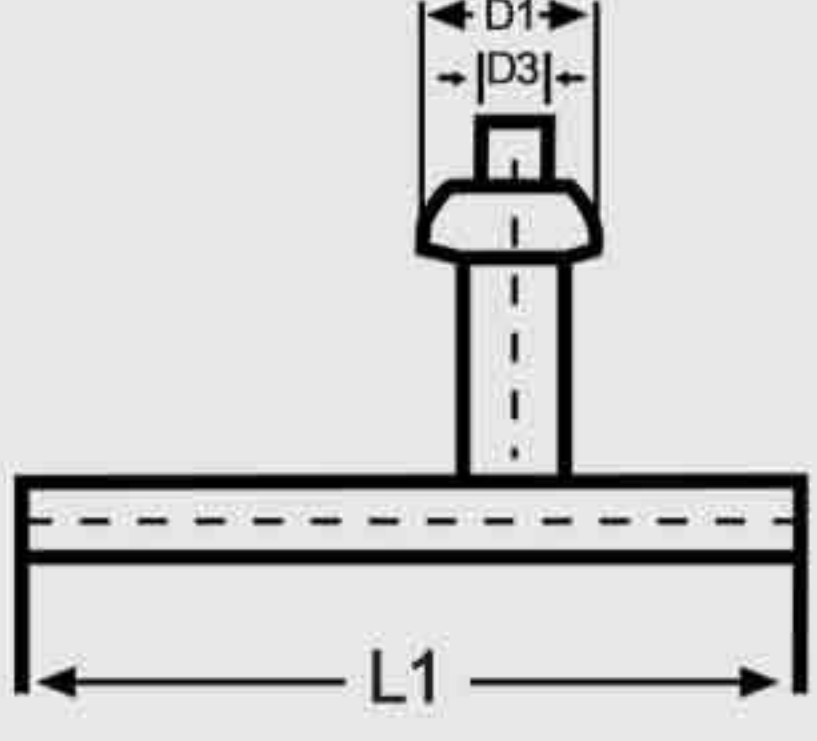
KEYLESS DRILL CHUCKS

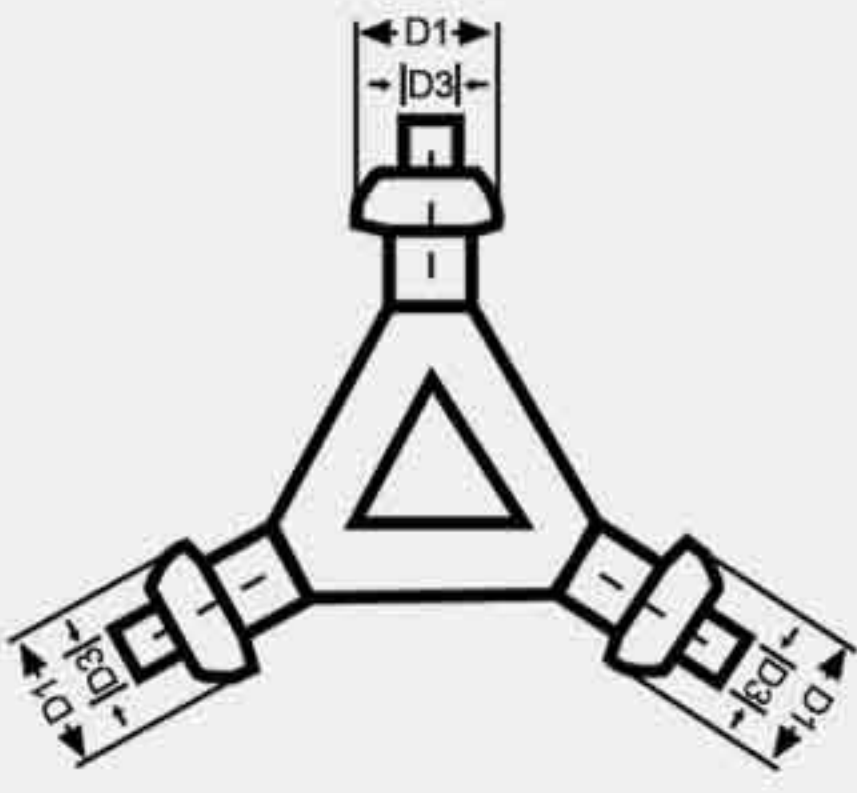
DRILL CHUCKS

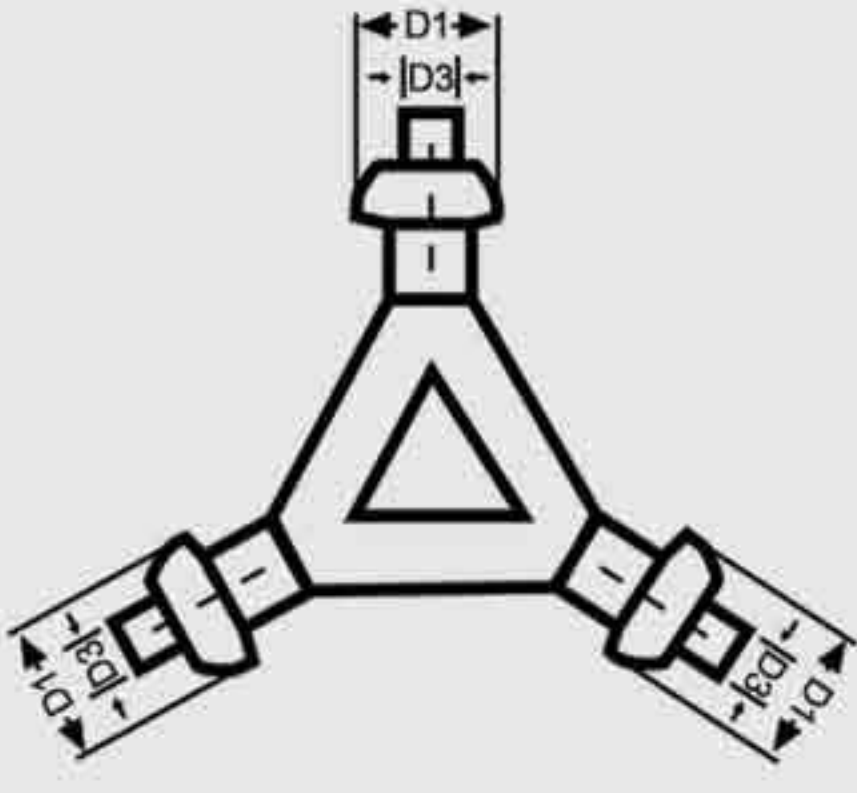
	Part #	Max. Capacity	Min. Capacity	Mount	Runout	Sleeve Diameter
	RV13M03	3/8"	0.03"	3/8"-24 UNF	0.013"	1.7"
 Replaces Milwaukee 42-66-8003, 42-66-0090, 42-66-0091	RV13M14	1/2"	0.03"	9/16"-18 UNF	0.013"	1.66"
	ST13B	1/2"	0.06"	1/2"-20 UNF	0.013"	1.7"

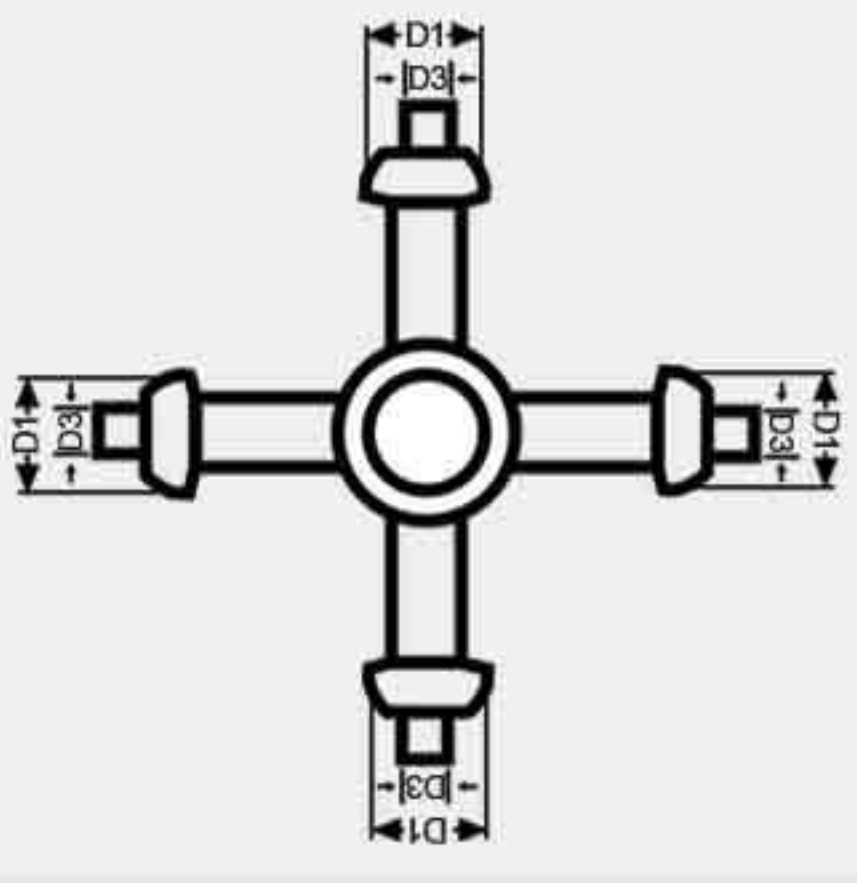
KEYLESS MINI CHUCKS



	Part #	Shank	Length	Mount	Shaft	Dimensions
	J016	1/4"	2-3/8"	3/8" - 24	1"	1-3/8" length x 1" dia
	J018	1/4"	2"	M8 x 0.75	1-1/8"	15/16" length x 3/4" dia
	S3824	--	1-3/4"	3/8" - 24	1/4"	--

		Part #	D1 mm	D3 mm	L1 mm	Fitment	Fits SE #
		S2-TH5B	17.4	5.9	80	1/2"	J3513A J3513B J3713A
		S3-TH1A	20.6	7.9	85	5/8"	J3516A
		S8-TH50C	19.1	6	108	--	J3113 J3113HH
		S3-TS	11.9 11.6 15.9	6.0 5.3 5.9	--	3/8" 1/2"	-- --
		S3-TL	16.6 18.8 15.9	5.9 6.2 6.7	--	1/4" 3/8"	-- --
		S4-TL	16.3 17.4 21.2 16.2	3.9 6.0 8.0 6.9	--	3/8" 1/2"	-- --
		S14-TC4A	--	--	--	3/8"	--
		S3-TC6A	--	--	--	5/8"	--
	RUBBER CHUCK KEY HOLDER	S2CKH	--	--	--	--	--









	Part #	Capacity	Shank
	ALC5491	2" Die Mini Chuck	MT-1 & MT-2

HOLE HAWG SPINDLE ASSEMBLY SERVICE KITS

	Part #	Capacity	Speed	Type	OE P/N	Includes Part #
	M1670	1/2" Keyed	2 Speed	Hole Hawg Service Kit	Milwaukee 38-50-5001	1. 48-66-1481 1/2" Reversing Slotted Chuck 2. 06-75-3155/50 1/4"- 20 x 1" Socket HD. Screw - L.H. Thread 3. 48-66-3280 Chuck Key 4. 38-50-5000 Spindle Shaft 5. 43-78-0670 Driver Hub Washer
	M1670-2	1/2" Keyed	2 Speed	Hole Hawg Service Kit	Milwaukee 38-50-5001	1. 48-66-1481 1/2" Reversing Slotted Chuck 2. 06-75-3155/50 1/4"- 20 x 1" Socket HD. Screw - L.H. Thread 3. 48-66-3280 Chuck Key
	M1670-T (J3113HH)	1/2" Keyed	2 Speed	Hole Hawg Threaded Chuck	Milwaukee 38-50-5001	1. 48-66-1481 1/2" Reversing Slotted Chuck 2. 06-75-3155/50 1/4"- 20 x 1" Socket HD. Screw - L.H. Thread 3. 48-66-3280 Chuck Key 4. 45-88-0330 Chuck Spacer Washer

	Part #	Description
	SE 06-07-3150	1/4"- 20 x 1" Socket HD. Screw - L.H. Thread
	SE 45-88-0330	Chuck Spacer Washer

LATHE CHUCKS

	Part #	Description
  <p>OEM SKIL PRODUCT</p>	80111	Skil Saw 8 oz. Tube-Worm Drive Saw Grease Lubricant
 <p>LIGHT WEIGHT ALUMINUM</p> <p>REPLACES SKIL 1619X01350 / 1619X01356</p>	ST77A	Foot Assembly / Base Plate Fits Worm Drive SkilSaw HD77 series
 <p>ADJUSTABLE CIRCULAR SAW RIP FENCE/EDGE GUIDE</p>	MZ745	Skil / Bosch 13896, 2610034814, 2610914629 Screw (OE P/N 2610353372) Spring (OE P/N 26100181014)
 <p>RIP FENCE KIT</p>	MZ750	Makita 199249-8
 <p>RAFTER SPRING HOOK UNIVERSAL BRACKET</p>	M745	Skil Saw & other Applications
 <p>SPRING LOADED RAFTER HOOK/RETRACTABLE NAIL GUN / SAW HANGER WITH UNIVERSAL BRACKET</p>	M745RB	Metabo HPT NR83A, NR83A2, NR90AE & Skil Worm Drive Saw (HD77)
 <p>AFTERMARKET WORMDRIVE SAW REPLACEMENT SAW HOOK</p>	M745-SH	Skil 2610913915

SAW PARTS

		Part #	Replaces
	"WIDE" VERSION RAFTER SPRING HOOK UNIVERSAL BRACKET	M745W	Skil Saw & Metabo HPT NR83A
	CARBON BRUSH CAP 2/PK	S77-CAP	Replaces Skil 1619X01268, 3603463500 Ridgid 512010001
	UPPER HANDLE	SUH77	Skil 1619X01205 (Red) Skil 1619X01204 (Grey)
	RED TOP HANDLE	STH77	OE # 1619X04707 (Red)
	FLANGE	S77-24	Skil 1619X02969
	BLADE NUT	S77-26	Skil 2610000050
	AFTERMARKET BLADE NUT WRENCH	S77-28	Skil 2610095106 & Bosch 1619X01144
	AFTERMARKET CARRIAGE BOLT	S77-30	Skil 2610911837
	REPLACEMENT CARRIAGE BOLT (15MM LONG THREAD)	S77-30S	Skil / Bosch 2610911837
	LEVER ASSEMBLY	S77-54	Skil 2610317088
	EDGE GUIDE / RIP FENCE SCREW & SPRING	MZ745-RK	2610353372 (Screw) 26100181014 (Spring)
	CARBON BRUSH HOLDER	S77-56	Skil 1619X04708, 1619X01267, 2610329940

SAW PARTS

	Part #	Replaces
<p>FULL SERVICE KIT</p> 	<p>S77-K2</p>	<p>KIT INCLUDES:</p> <ul style="list-style-type: none"> · EC143 9 Foot 14 AWG SJO 3 Wire Electrical Cord · Boot-A Strain Relief · S77 Carbon Brush · S77-CAP Brush Cap · SW77 Saw Switch · Skil 80111 Grease Lubricant
	<p>S77-K1</p>	<p>CARBON BRUSH & BRUSH CAP HOLDER SET (2/pack) OE # 1619X01351 / 26103-20391 OE # 1619X01268, Ridgid 512010001</p>

	Part #	Description
	SEW710	Inner Flange and Lock Nut 5/8"-11 & Wrench Kit
	SEWA58K	Adjustable Spanner Wrench Kit with Grinder Lock Nuts
	SEWA20	Adjustable Wrench, Grinder Lock Nut
	SEW35	Wrench, Grinder Lock Nut Bosch OE P/N 1607950052
	LN5811ML	5/8"-11 Quick Change Disc Flange Locking Nut for 5" Grinders
	LN5811MT	5/8-11" Thread Quick Change 1.75" O.D Disc Flange Locking Nut
	LN5811SL	5/8"-11 Thread Grinder Self Tightening Quick Change Lock Nut for 6" to 9" Grinders
	FL2610906323	Grinding Wheel Outer & Inner Flange 5/8"-11 All Bosch 4-1/2" 5" Grinders Milwaukee OE P/N 6140-6, 6141, 6145 & 6160-20
	G710	Inner Flange and Lock Nut 5/8"-11 , Grinder
	IF224399-1	Inner Flange, Grinder Makita OE P/N 224399-1

SAW PARTS

	Part #	Description
	LN5811	Lock Nut 5/8"-11, Grinder
	GA-EXT	Grinder Arbor Extension - 5/8"- 11 Thread x 2"
	GA-3	1/4" and 3/8" combination Mandrel Kit with 1/4" shank for High Speed Cutting Wheels
	GA-M1058	Grinder Adapter Converts M10 x 1.5 Grinder Arbor Threads into 5/8"-11 Arbor Spindle
	GA-M1058-1	Grinder Adapter Converts M10 x 1.25 Grinder Arbor Threads into 5/8"-11 Arbor Spindle Makita OE P/N 323015-A Dewalt OE P/N DW4900
	GA-M1038	Adapter Convert M10 Threads to 3/8"-16 Threads, Used in Assembly of Profile Wheel
	GA-M1058-16	Adapter Convert M10 Threads to 5/8"-16 Threads, Used in Assembly of Profile Wheel



Part#: PS7800
Airless Paint Spray Gun
High Pressure - 3600PSI
Universal Design

Specifications:
 Max WP: 3600 PSI 248 bar
 Feed inlet: 1/4 NPSM
 Trigger: 4 Fingers
 Material: Aluminum
 Hook for Easy Hanging
 G 7/8 Female Threads



Quick Change Tungsten Carbide
Reversible Airless Spray Tip for
Airless Paint Sprayer Guns

Part#
 PS75-315
 PS75-415
 PS75-513
 PS75-619
 PS75-621

Specification:
 Material: Tungsten Carbide
 Max Working Pressure: 3600 PSI
 Fan Width: (#315, 6"), (#415, 8"), (#513, 10"),
 (#619, 12"), (#621, 12")
 Tip Size: (#315, 0.015"), (#415, 0.015"),
 (#513, 0.013"), (#619, 0.019"), (#621, 0.021")



Airless Paint Spray Gun Filter Universal
Fit 100 Mesh – 2pcs/pack

Part#
 PS740-50 (50 Mesh)
 PS740-10 (100 Mesh)
 PS740-150 (150 Mesh)



Extension Pole for Airless Paint Spray Guns

PS78-12 (12")
 PS78-24 (24")
 PS78-30 (30")



PS7800-1
G 7/8 Thread Tip Guard for
Airless Paint Spray Gun



PS740B
Airless Paint Sprayer
Replacement Inlet Strainer



PS77-10
One Seals Tip
Gaskets for Airless
Paint Spray Guns,
3Pcs/Pk



PS76-00
Airless Paint Sprayer
Piston Rod Compatible
with Most Airless Sprayer



PS77-00
Paint Sprayer Piston Washer Compatible with
Most Airless Sprayer



PS8660
Airless Paint Spray
Washer for R8660



PS8620
Airless Paint Spray
Washer for R8620

90 DEGREE CHECK VALVES

CVC7021
1/4" 90° Left Check Valve

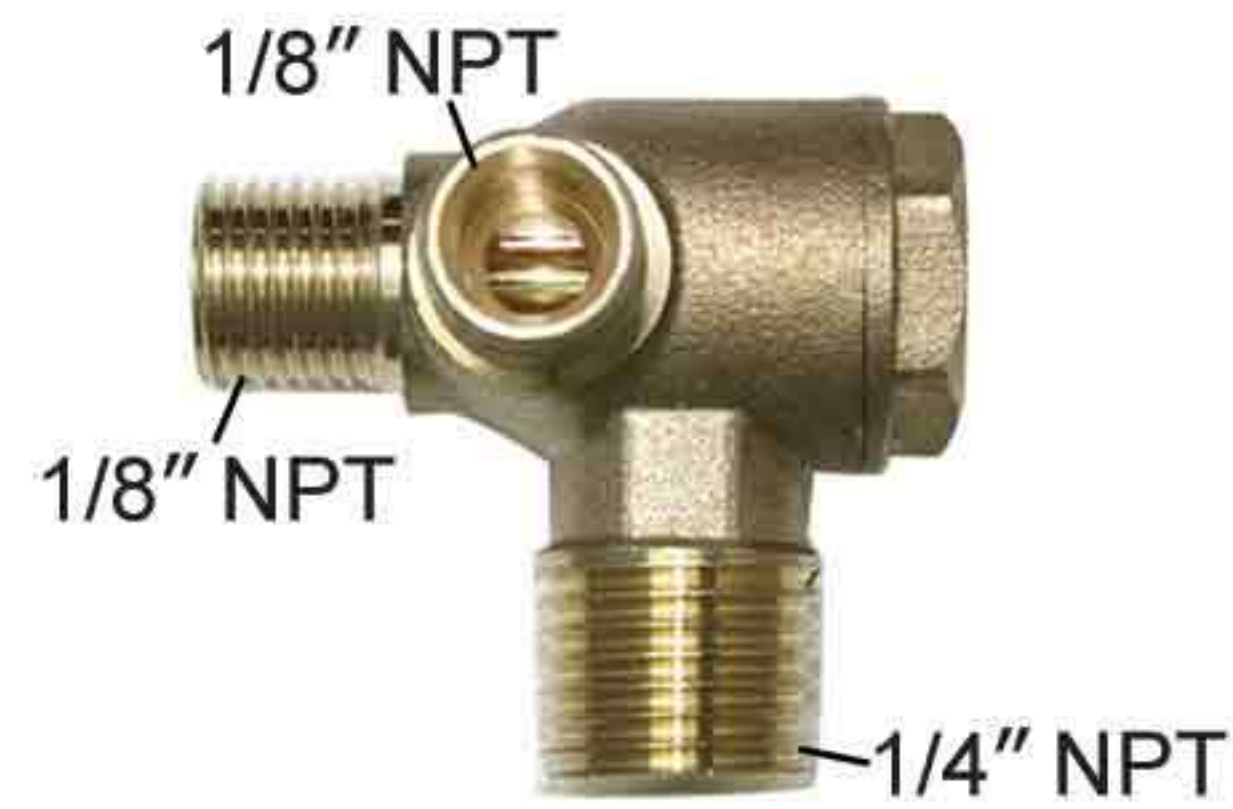

CVC7031
1/2" 90° Left Check Valve



1/2" NPT LINE PORT STEEL CHECK VALVE

CVC7042
Fits EMGLO & Other Compressors



Specifications:
Material: Steel
Thread: 11/16"-20 UNS-2A
Compressor Input Thread: 1/2" NPT
Unloader Line Port Thread: 1/8" NPT
Maximum Pressure: 500 PSI
Maximum Temperature: 260°C
Flow Rate @ 150 PSI: 2500 L/min

1/2" NPT LINE PORT STEEL CHECK VALVE

CVC7043
Fits EMGLO & Other Compressors



Specifications:
Material: Steel
Thread: 11/16"-20 UNS-2A
Compressor Input Thread: 1/2" NPT
Unloader Line Port Thread: 1/8" NPT x 2 - Two Ports
Maximum Pressure: 500 PSI
Maximum Temperature: 260°C
Flow Rate @ 150 PSI: 2000 L/min

1/2" NPT LINE PORT STEEL CHECK VALVE

CVC7044
Fits EMGLO & Other Compressors



Specifications:
Material: Steel
Thread: 1/2" NPT
Compressor Input Thread: 1/2" NPT
Unloader Line Port Thread: 1/8" NPT
Maximum Pressure: 500 PSI
Maximum Temperature: 260°C
Flow Rate @ 150 PSI: 2800 L/min

1/2" NPT LINE PORT BRASS CHECK VALVE

CVC7041
Fits EMGLO & Other Compressors



With Cold Start

Specifications:
Material: Brass
Thread: 1/2" NPT
Compressor Input Thread: 1/2" NPT
Unloader Line Port Thread: 1/8" Compression Fitting
Maximum Pressure: 500 PSI
Maximum Temperature: 260°C
Flow Rate @ 150 PSI: 2500 L/min

1/4" NPT COLD START VALVE - 1.7 BAR - 25 PSI

CVS7045



With Cold Start

Specifications:
Material: Brass
Thread: 1/4" NPT
Valve closes at 25 PSI
Valve closes with 2.5 SCFM flow

COMPRESSOR DRAIN VALVES



VP42
1/4" NPT Male
Knurled Knob
Type Drain Cock Valve



VP40
1/4" FPT (inlet) x 1/4" MPT
(outlet) Mini Drain Valve



VP40B
1/4" FPT (inlet) x 1/4" MPT
(outlet) Mini Ball Drain
Valve - Brass

WING FLANGE TYPE DRAIN COCK VALVE



VP21
1/8" MPT

VP41
1/4" MPT

BALL VALVES

MINI BRASS BALL VALVE WITH LEVER (WP 225 PSI)



VB440
1/4" FPT x 1/4" MPT
VB660
3/8" FPT x 3/8" MPT

VB880
1/2" FPT x 1/2" MPT

BRASS BALL VALVE (WP 600 PSI)



VB04
1/4" x 1/4" NPT Female
VB06
3/8" x 3/8" NPT Female

VB08
1/2" x 1/2" NPT Female
VB12
3/4" x 3/4" NPT Female
VB16
1" x 1" NPT Female

COMPRESSOR PRESSURE RELIEF VALVES

V095-4
1/4" MPT w/pull Ring - 95 PSI

V140-4
1/4" MPT w/pull Ring - 140 PSI

V140-8
1/8" MPT w/pull Ring - 140 PSI

V165-4
1/4" MPT w/pull Ring - 165 PSI

V165-8
1/8" MPT w/pull Ring - 165 PSI

V200-4
1/4" MPT w/pull Ring - 200 PSI

ASME CERTIFIED BRASS SAFETY VALVE



CPM18
Compressed Air Tank Twist
On/Off Fill Valve / Release Valve
with Safety & Schrader Valve
Gauge Port: 1/8" NPT
Inlet: 1/4" NPT with Twist On/Off Valve
Tank Port: 1/2" NPT



Pressure Rating:
150PSI

TIMED ELECTRIC AUTO DRAIN VALVE, 1/4" NPT 110 VOLTS

VDA-140

Features:

- Unique Mounting system
- Dual internal drain ports
- Solid state adjustable with test button
- With UL approved Manual Timer

Specification:

- Pipe Size: 1/4" NPT Female
- Flow Hole(Orifice): 3/16"(4.7mm)
- Drain Rate: 0.75 GPM
- Adjustable Drain Cycle: 0.5 min. to 45 min.
- Discharge Time: 0.5 sec. to 10 sec.
- Voltage: 110V, 50/60 Hz
- Max. Pressure: 230 PSI
- Operating Temp. Range: 34°F to +140°F
- Amps AC: 0.2A
- Protection: IP65
- Body Material: Brass
- Valve: 2-way normally closed
- Includes 6 ft. Power Cord with US Standard Plug

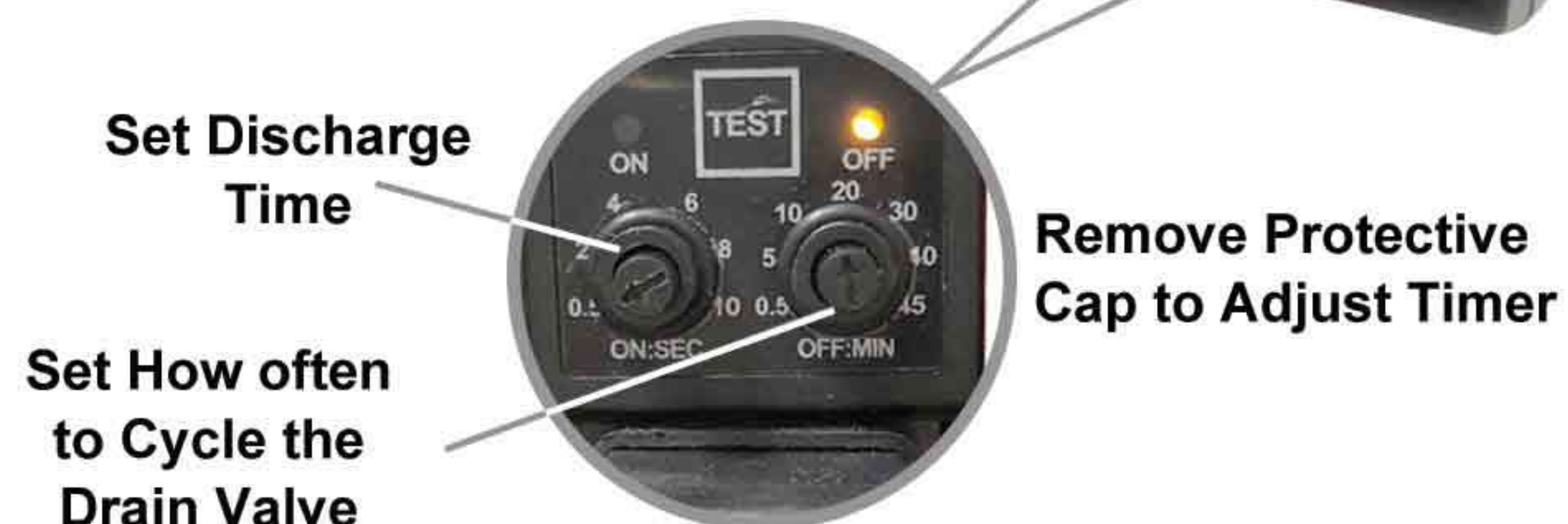

VALVES

CABLE OPERATED AIR TANK DRAIN VALVE, 1/4" MALE NPT WITH 5FT CABLE

VP44

Specification:

- Valve Material: Brass
- Cable Material: Vinyl Covered Steel
- Inlet Thread: 1/4" NPT Male
- Cable Length: 5ft
- Drain Valve Pressure Range: 200 PSI max
- Max. Temperature: 200°F



1/2" x 1/4" MPT COMPACT BALL VALVE Y STRAINER COMBINATION (MALE TO MALE) 600 PSI

VP48

Specification:

- Working Pressure: 600 PSI
- Temperature Range: -4°F to 200°F
- Brass Body Chrome Plated
- Chrome Plated Ball
- PTFE Seals
- ABS Plastic Handle
- Male to Male Connection

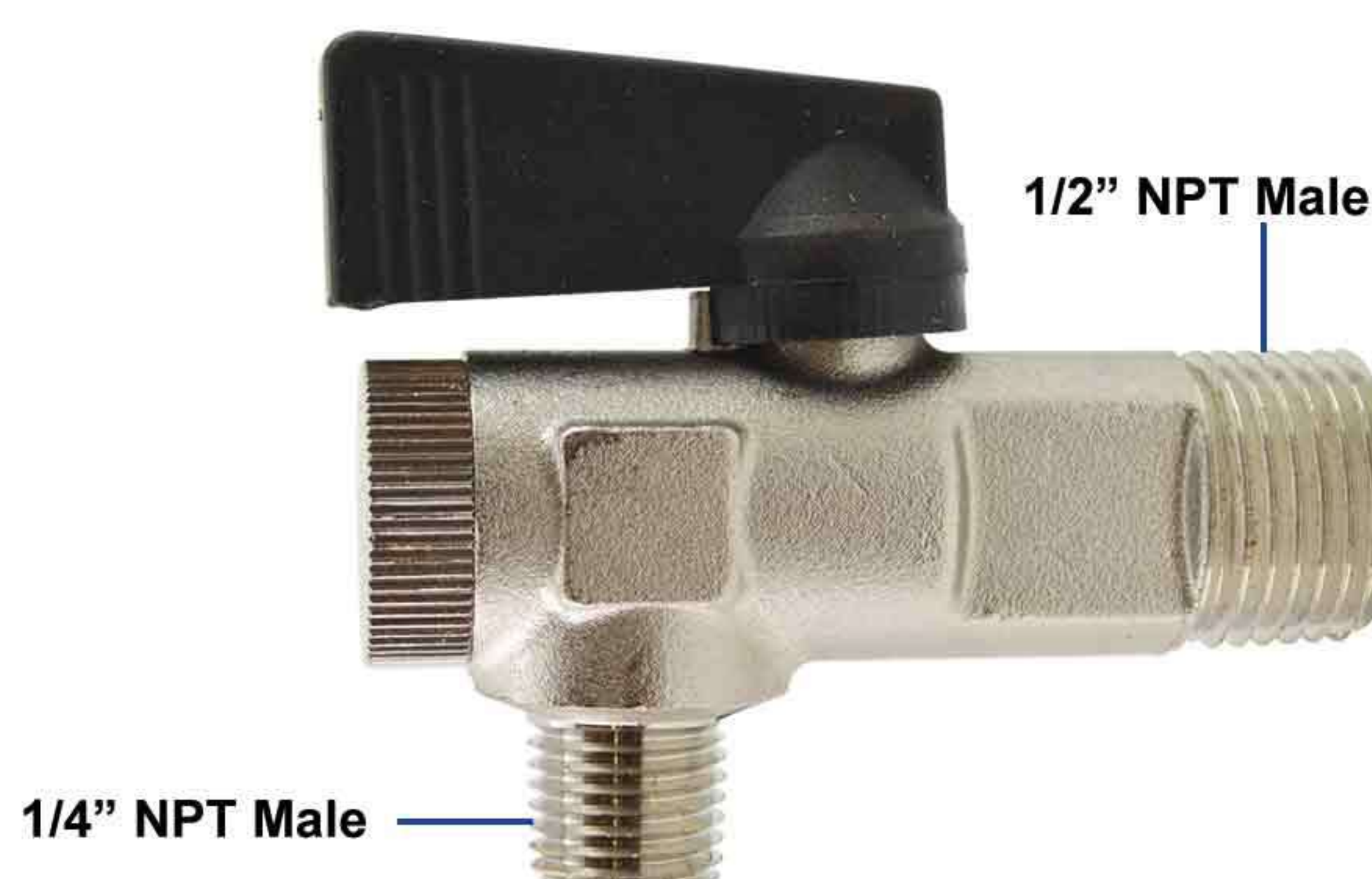

PILOT UNLOADER / DISCHARGE VALVE FOR AIR COMPRESSORS

CVD7049

Specifications:

- Preset at 95-125 PSI
- Operating Pressure: 20-250 PSI
- Operating Temp. Range: -15° to 400°F
- Max Flow Rating: 20 SCFM
- Pilot Inlet: 1/4" Male NPT
- Pilot Outlet: 1/8" Female NPT
- Unloader Inlet: 1/4" Compression Thread
- Body/Fittings: Brass
- O-Rings: Silicone/Viton
- Poppets: Reinforced PTFE
- Springs: Stainless Steel

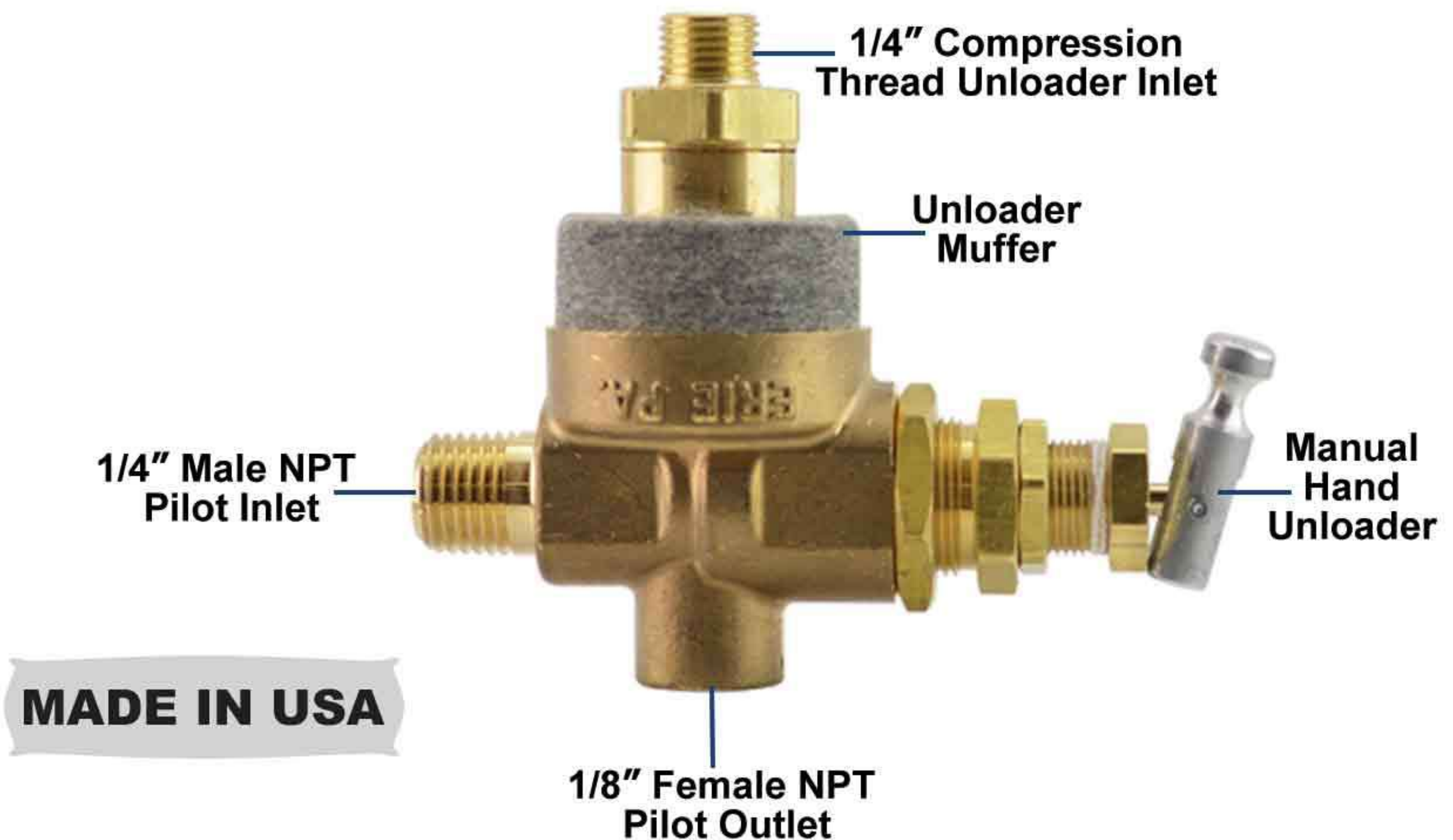

UNLOADER CONTROL PILOT VALVE FOR AIR COMPRESSORS (EMGLO/DEWALT STYLE)

CVP7050

Specifications:

- Preset at 95-125 PSI
- Operating Pressure: 20-1200 PSI
- Operating Temperature Range: -15° to 400°F
- Inlet Connection Port: 1/4" Male NPT
- Outlet Connection Port: 1/8" Female NPT
- Body/Fittings: Brass
- O-Rings: Silicone/Viton
- Poppets: Reinforced PTFE
- Springs: Stainless Steel

This item fits the following models:

- Pilot Valve for pumps w/ unloaders (Emglo/Dewalt style) - RCB style

Dewalt: 5130236-00

Emglo Parts

K5HGA-8P, K5GA-8P, K5WGA-8P, K5CGA-8P, K5HGA-17P, K5GA-17P, K5WGA-17P, K5CGA-17P, G8HGA-17P, G8GA-17P, G8CGA-17P, G8VGA-17P, G8KGA-17P, G8HGA-8P, G8GA-8P, G8CGA-8P, G8VGA-8P, G8KGA-8P.

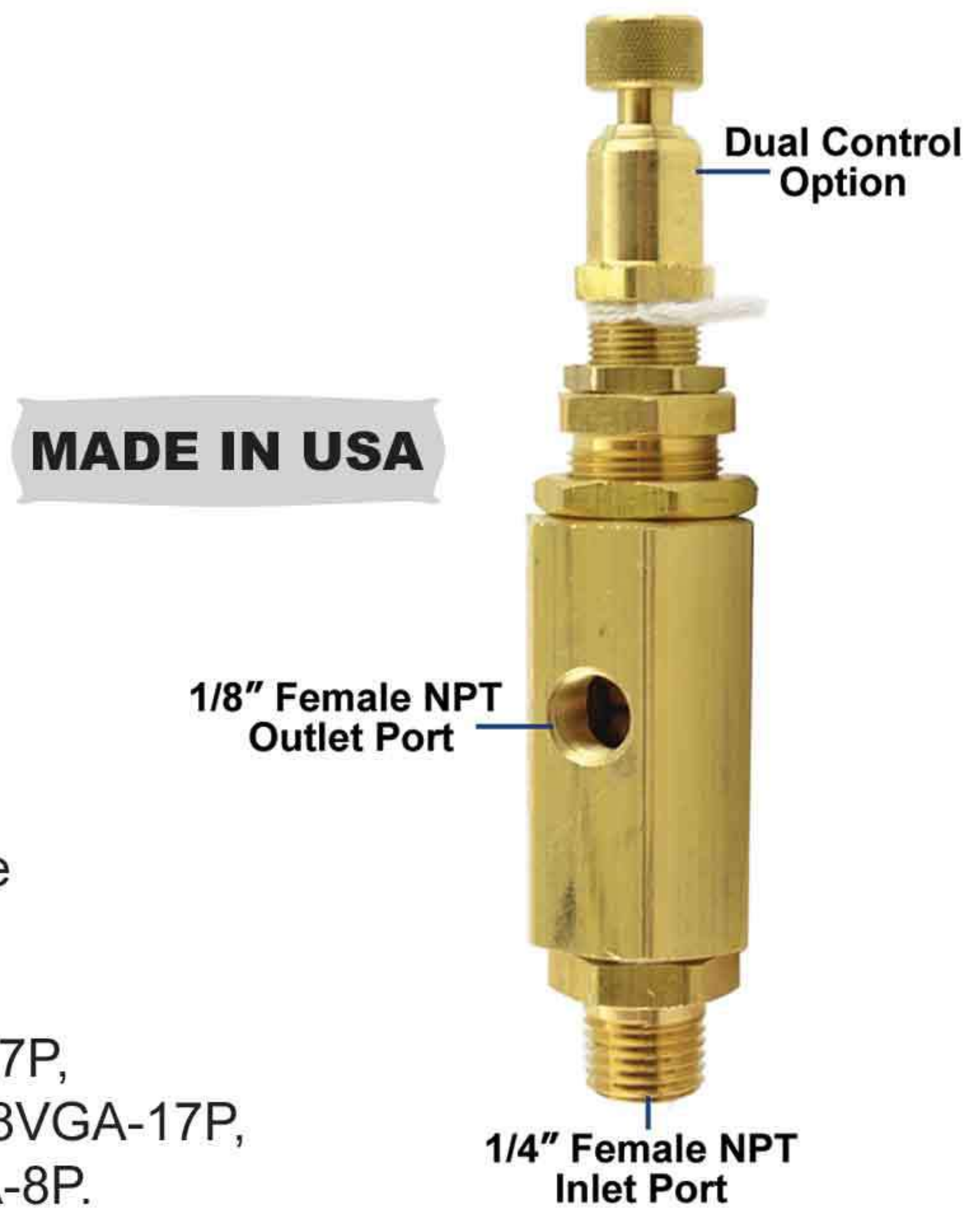

PILOT VALVE WITH MOUNTING BOSS

CVP7051

Specifications:

- Preset at 95-125 PSI
- Operating Pressure: 20-1200 PSI
- Operating Temperature Range: -15° to 400°F
- Inlet Connection Port: 1/4" Female NPT
- Outlet Connection Port: 1/8" Female NPT
- Outlet Connection Port: 3/8-16" UNC Mount
- Body/Fittings: Brass
- O-Rings: Silicone/Viton
- Poppets: Reinforced PTFE
- Springs: Stainless Steel

MADE IN USA

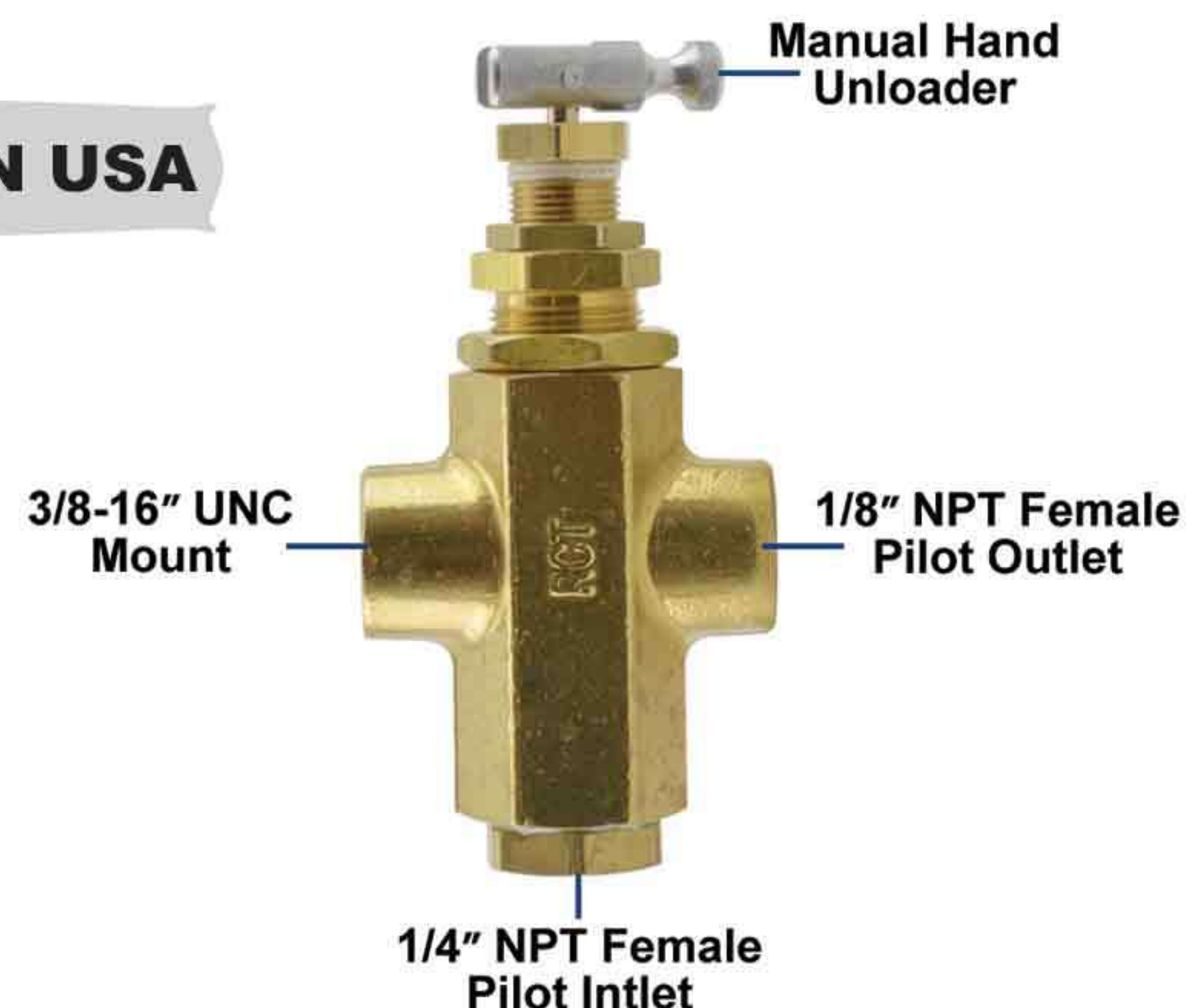

UNLOADER CONTROL PILOT CHECK VALVE FOR AIR COMPRESSORS

CVT7052

Specifications:

- Preset at 95-125 PSI
- Operating Pressure: 20-250 PSI
- Operating Temperature Range: -15° to 400°F
- Max Flow Rating: 30 SCFM
- Inlet Connection Port: 1/2" Female NPT x 2 (Top and Side)
- Outlet Connection Port: 1/2" Female NPT
- Body/Fittings: Brass
- O-Rings: Silicone/Viton
- Poppets: Reinforced PTFE
- Springs: Stainless Steel

MADE IN USA

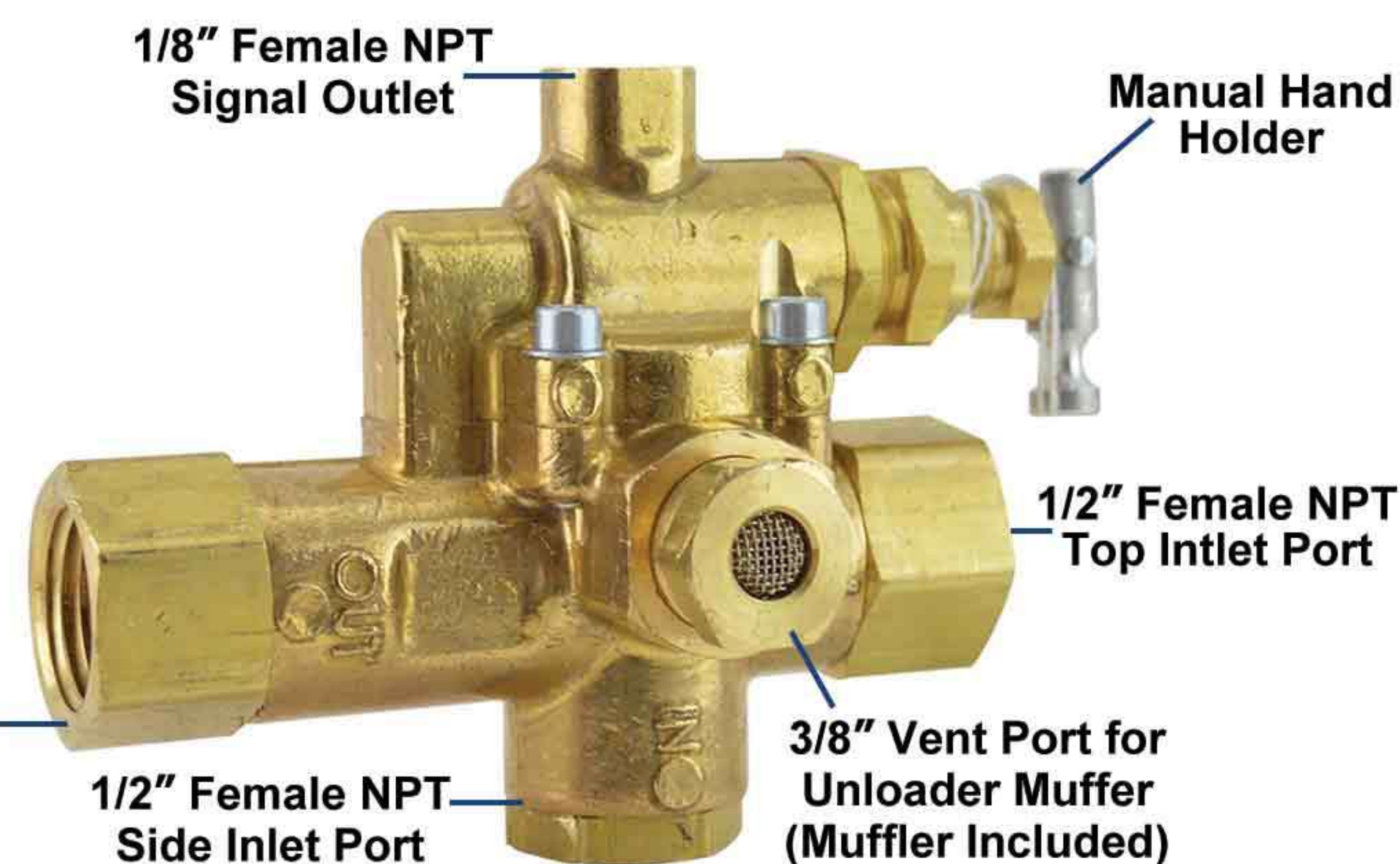

AIR COMPRESSOR THROTTLE CONTROL CABLE FOR PILOT VALVE

CVT7053

24" BULLWHIP

CVT7054

36" BULLWHIP

MADE IN USA

Features:

- Can be customized to adapt to specific engines
- Brass construction with Viton seals, stainless steel springs, and stainless-steel cable.
- The cable is self-cleaning. Routing clamps are used to mount and protect the cable.

Specification:

- Cable Length: (CVT7053: 24"), (CVT7054: 36")
- Min Actuation Pressure: 80 PSI
- Max Operating Pressure: 500 PSI
- Operating Temperature Range: -15° to 400°F
- Stroke Length: 1.00"
- Retracted Spring Force: 16.89 lbf
- Inlet Connection: 1/8" Male NPT
- Works with both under 8HP & over 8HP compressors



ALL PURPOSE DRY PRESSURE GAUGES

Interstate Pneumatics Dry Pressure Gauges are suitable for a wide range of applications for air, water, oil or other fluids which are compatible with brass and bronze. Painted, pressed steel case and shatterproof polycarbonate clear plastic provides durability and safety. Interstate Pneumatics Rear Mount Gauge inlet threads are positioned in the back (rear) center area.

GAUGES



Model	Range	Dial Dia.	Case/Bezel	Port Size/Port Direction
G2001-160	0 - 160 PSI	1-1/2"	Black	1/8" NPT Bottom Mount
G2001-200	0 - 200 PSI	1-1/2"	Black	1/8" NPT Bottom Mount
G2012-100	0 - 100PSI	2"	Black	1/4" NPT Bottom Mount
G2012-160	0 - 160 PSI	2"	Black	1/4" NPT Bottom Mount
G2012-200	0 - 200 PSI	2"	Black	1/4" NPT Bottom Mount
G2022-160	0 - 160 PSI	2-1/2"	Black	1/4" NPT Bottom Mount
G2032-160	0 - 160 PSI	3"	Black	1/4" NPT Bottom Mount
G2100-160	0 - 160 PSI	1-1/4"	Black	1/8" NPT Rear Mount
G2101-160	0 - 160 PSI	1-1/2"	Black	1/8" NPT Rear Mount
G2101-200	0 - 200 PSI	1-1/2"	Black	1/8" NPT Rear Mount
G2111-160	0 - 160 PSI	2"	Black	1/8" NPT Rear Mount
G2112-160	0 - 160 PSI	2"	Black	1/4" NPT Rear Mount
G2112-200	0 - 200 PSI	2"	Black	1/4" NPT Rear Mount
G2122-160	0 - 160 PSI	2-1/2"	Black	1/4" NPT Rear Mount



GX20 2" Pressure Gauge Rubber Protector

OIL FILLED PRESSURE GAUGES

Interstate Pneumatics Oil filled gauges are filled with silicon based oil (Dimethyle Silicon). These gauges last longer because they have fewer moving parts. The oil filled gauge helps dampening pointer vibration and eliminates corrosion resulting from condensed water when installed in areas that have humid air. The oil thus minimizes wear and tear on the more delicate parts of the device.



GAUGES

Model	Range	Dial Dia.	Case/Bezel	Port Size/Port Direction
G7012-100	0 - 100 PSI	2"	Chrome	1/4" NPT Bottom Mount
G7012-200	0 - 200 PSI	2"	Chrome	1/4" NPT Bottom Mount
G7022-160	0 - 160 PSI	2-1/2"	Chrome	1/4" NPT Bottom Mount
G7022-300	0 - 300 PSI	2-1/2"	Chrome	1/4" NPT Bottom Mount
G7122-100	0 - 100 PSI	2-1/2"	Chrome	1/4" NPT Rear Mount
G7122-160	0 - 160 PSI	2-1/2"	Chrome	1/4" NPT Rear Mount
G7122-200	0 - 200 PSI	2-1/2"	Chrome	1/4" NPT Rear Mount
G7122-300	0 - 300 PSI	2-1/2"	Chrome	1/4" NPT Rear Mount

PAPER & FOAM FILTER STYLES IN 3/8", 1/2", 3/4", 1"

METAL BODY



Model # SA142 1/2" MPT
Model # SA143 3/8" MPT
 Paper Cartridge
 +
 Small Metal Body

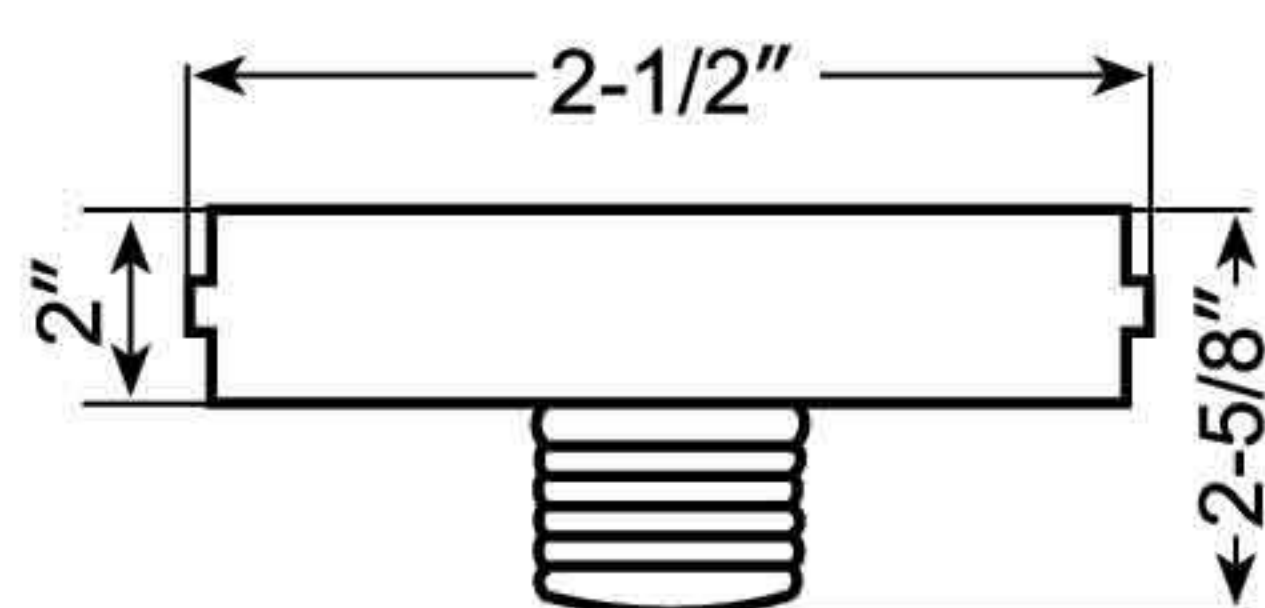

Model # SA14F
 Paper Replacement for
 SA142 + SA143
 Air Filter
 Element Only

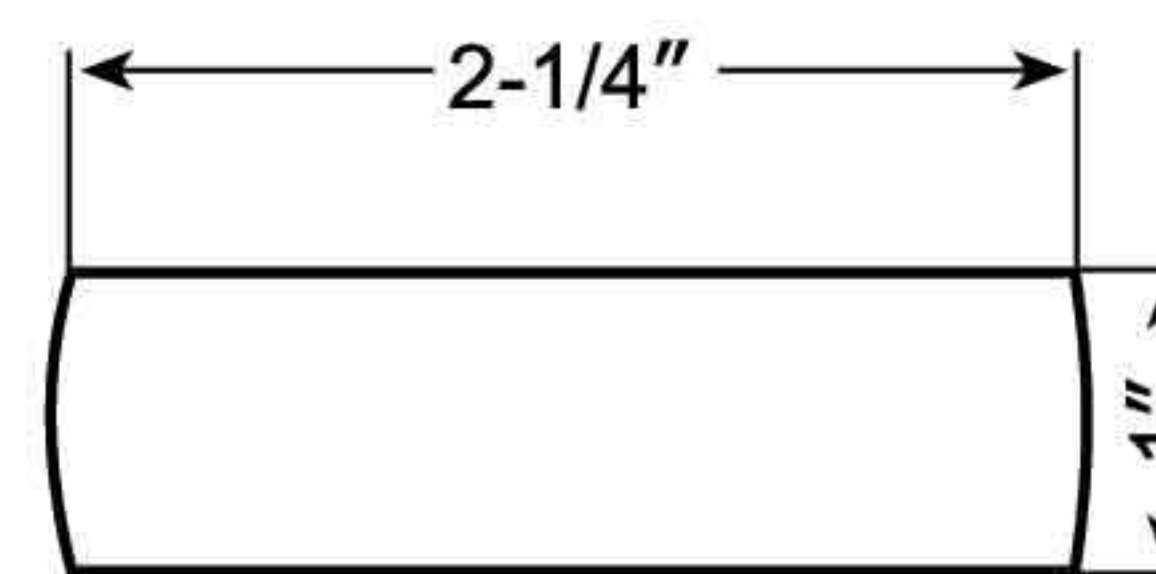

Model # SA144 1/2" MPT
 Paper Cartridge
 +
 Small Metal Body

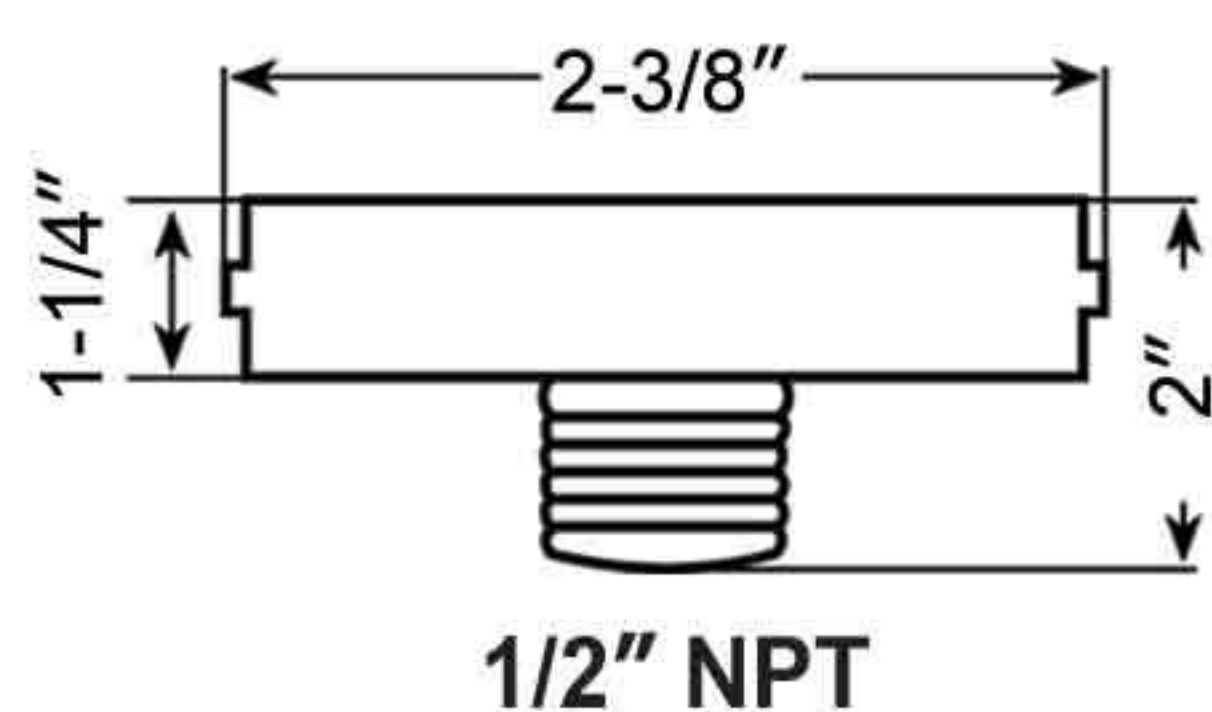

Model # SA144F
 Air In-Take Filter
 for SA144

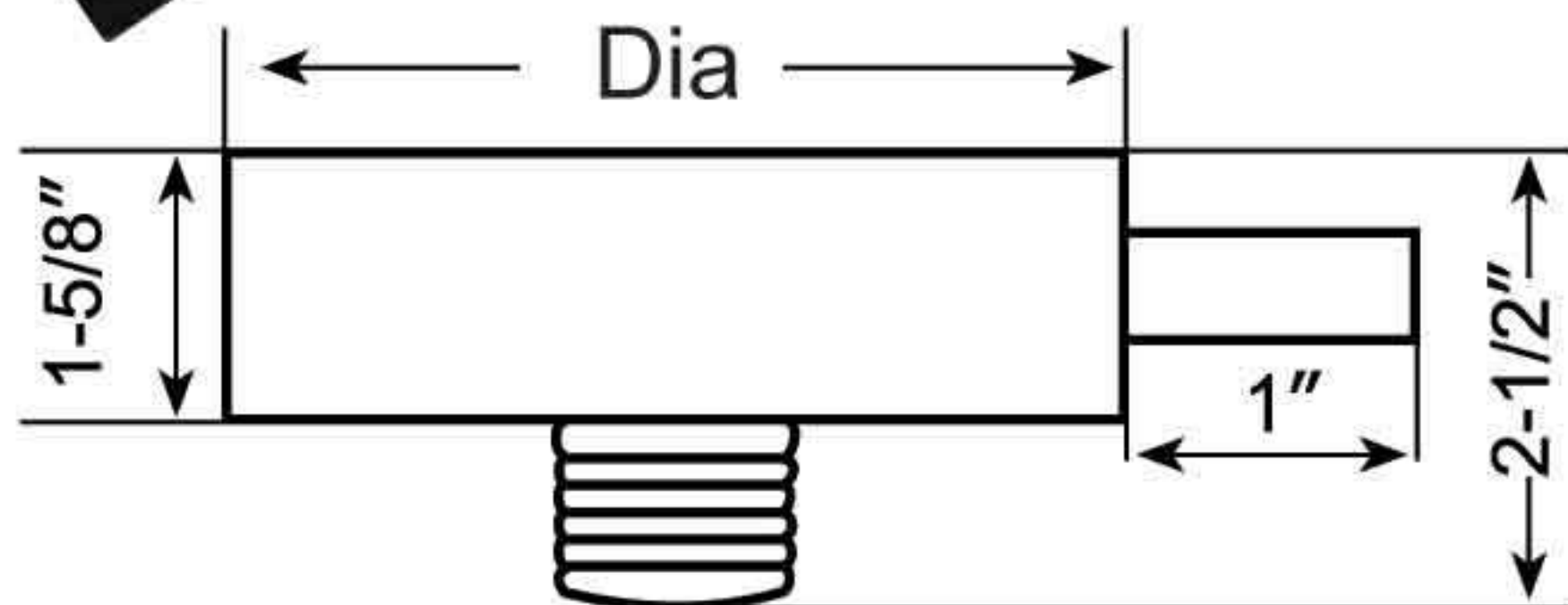

MODELS AVAILABLE

- SA9M** 4" Dia - 1/2" MPT Compressor Air Filter Metal Body w/Element
- SA9F** Air Filter ELEMENT ONLY - Paper Replacement for SA9M Body
- SA13** 5" Dia - 3/4" MPT Compressor Air Filter Metal Body w/Element
- SA13F** Air Filter ELEMENT ONLY - Paper Replacement for SA13 Body
- SA15** 6" Dia - 1" MPT Compressor Air Filter Metal Body w/Element
- SA15F** Air Filter ELEMENT ONLY - Paper Replacement for SA15 Body



Model # SA16F Air Intake Filter Element for Compressors

PLASTIC BODY



Model # SA9
 Paper Cartridge
 +
 Large Plastic Body
 1/2" MPT

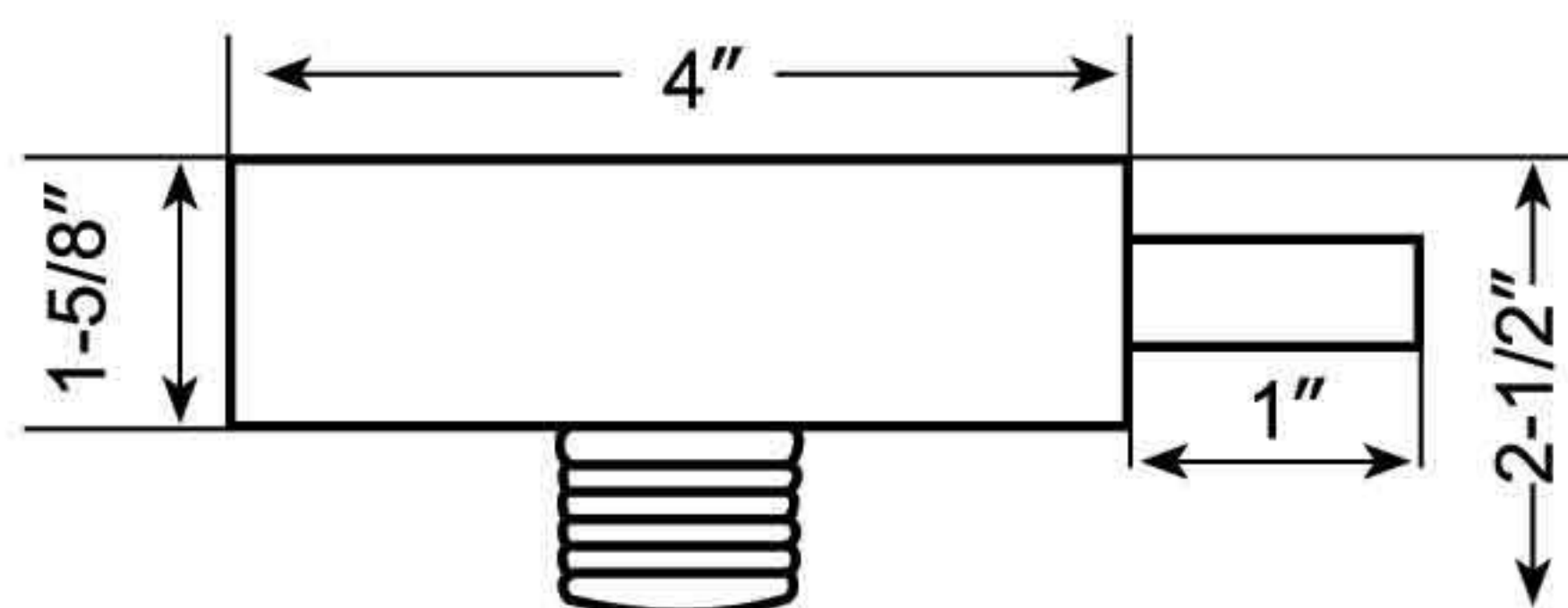

Model # SB191 1/2" MPT
Model # SB192 3/8" MPT
 Sponge Cartridge
 +
 Small Plastic Body

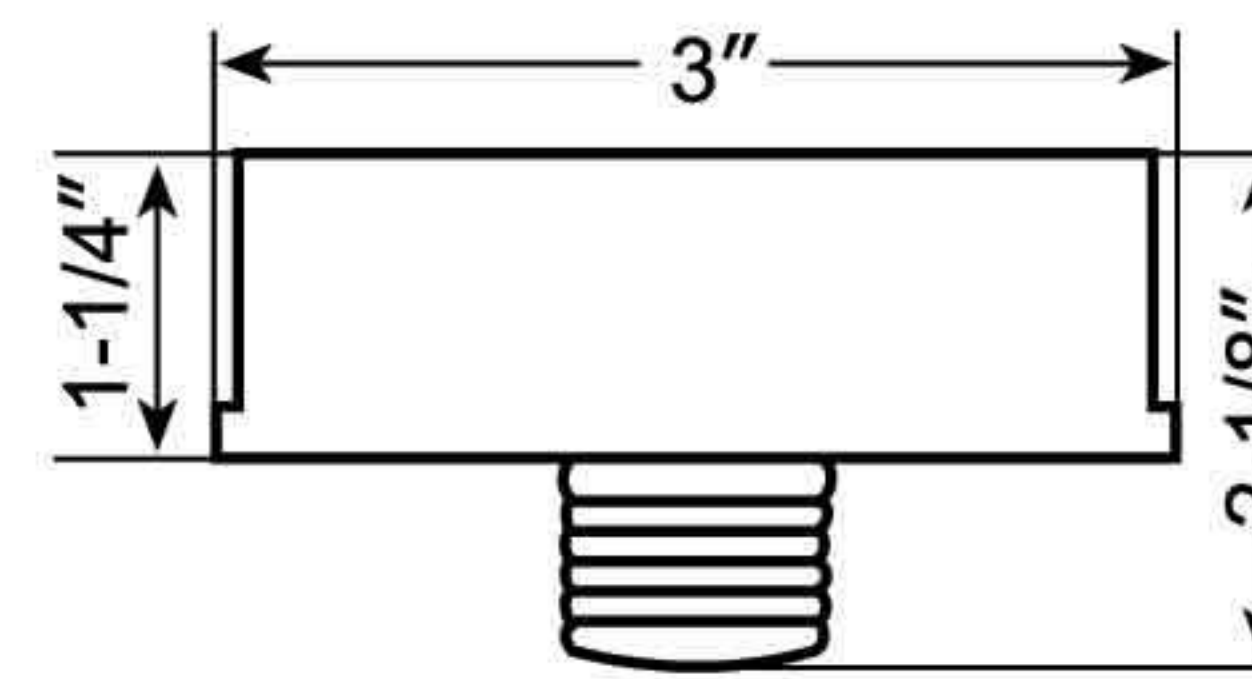

COMPRESSOR RUBBER FOOT

CFR7022

Rubber Foot for Compressor
(4pcs) for C1000



OD = 1-3/4"
Height = 7/8"
Bolt Hole = 3/16"

CFR7032

Rubber Foot for Compressor
(4pcs) for C2000



OD = 2"
Height = 1"
Bolt Hole = 5/16"

COMPRESSOR RELIEF TUBES



CTR7023

1/4" x 6.5" Nylon Sensor
Tube w/ Compression Nut

CTR7033

1/4" x 11.5" Nylon Sensor
Tube w/ Compression Nut

COMPRESSOR EXHAUST PIPES



CPE7024

1/4" Discharge Tube for
C1000 & Other Air Compressors

Length = 13" Long

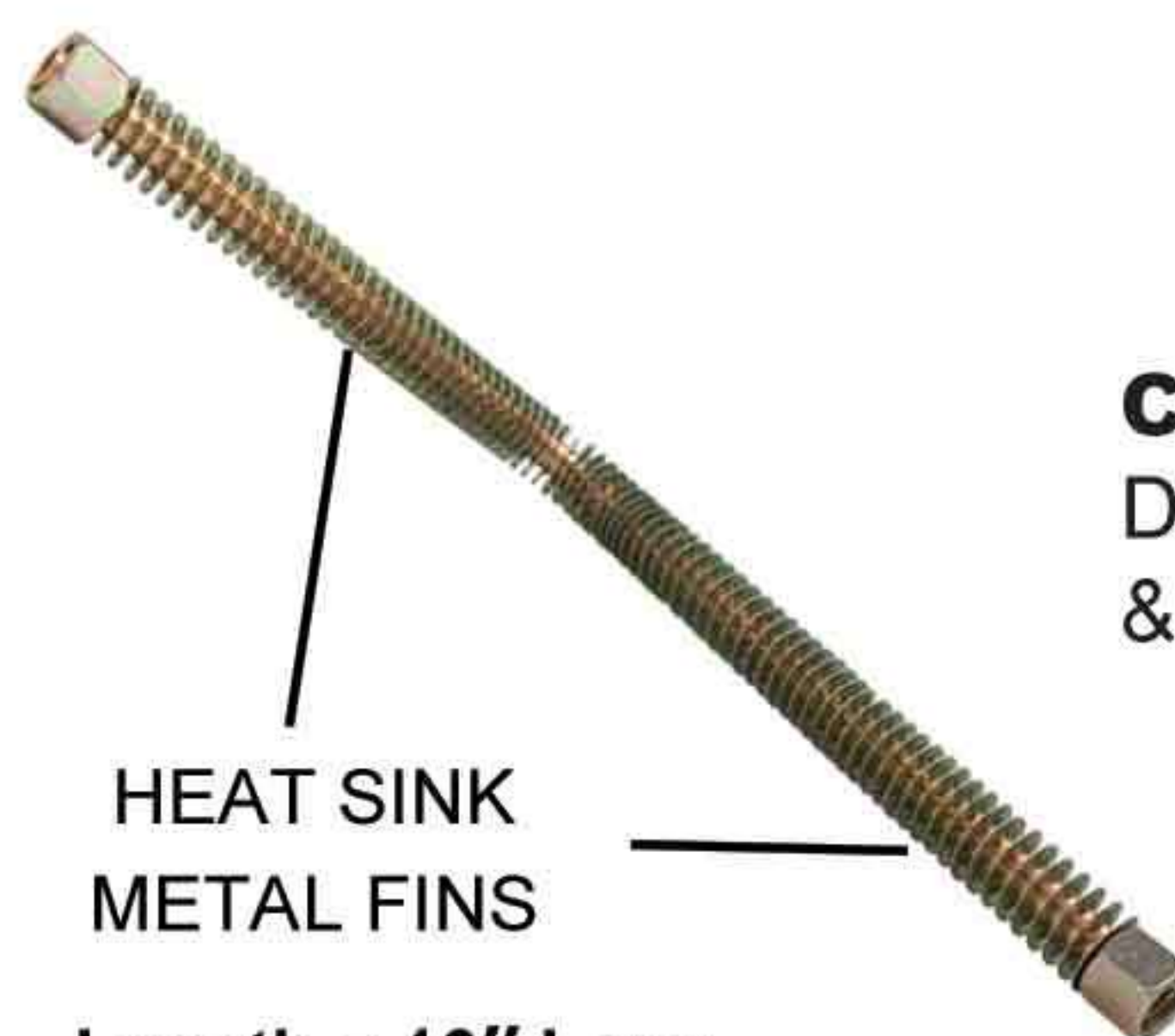

CPE7034

Discharge Tube for C2000
& Other Air Compressors

HEAT SINK
METAL FINES

Length = 16" Long

SMALL COMPRESSOR MANIFOLD FITTINGS

CPT44

Straight Tee Brass
Compressor Fitting
1/4" MPT (1) x 1/4" FPT (2)



CPF98

Three-Way Brass Manifold
Compressor Fitting 3/4" MPT
(1) x 1/2" FPT (2)



CPT44-5

Five-Way Brass Compressor
Fitting 1/4" FPT (5)



CPX44-2

Four-Way Brass Compressor
Fitting 1/4" MPT (1) x
1/4" FPT (2) 1/8" FPT (1)



COMPRESSOR OIL DIP STICK

CDS-78

COMPRESSOR OIL DIP STICK

Replaces Emglo/Dewalt part number 5140016-78, 5140026-43.

Compatible with:

Dewalt:

D55151 Type 3, D55152 Type 1, D55153 Type 2,
D55153 Type 3, D55154 Type 1, D55152 Type 2 1.1HP, AM782HC4V Type 2,



DOMESTYLE MANIFOLD KIT



FPM44-KH4
3 Way Aluminum 1/4" Dome Manifold with (3) 1/4" Steel Industrial Couplers x (1) 1/4" Industrial Steel Plug



FPM44-KH6
3 Way Aluminum 1/4" Dome Manifold with (3) 3/8" Steel Industrial Couplers x (1) 3/8" Industrial Steel Plug



FPM44-KH4B
1/4" Aluminum Dome Manifold with (3) x 1/4" Brass Industrial Couplers x (1) 1/4" Industrial Steel Plug

FLAT HEX STYLE MANIFOLD KIT



FPM44R-KH6
3 Way Brass 1/4" Flat-Hex Manifold with (3) 3/8" Steel Industrial Couplers x (1) 3/8" Industrial Steel Plug



FPM44R-KH4
3 Way Brass 1/4" Flat-Hex Manifold with (3) 1/4" Steel Industrial Couplers x (1) 1/4" Industrial Steel Plug



FPM44R-KH4B
1/4" Brass Round Manifold with (3) x 1/4" Brass Industrial Couplers x (1) 1/4" Industrial Steel Plug



FPM66R-KH4B
3/8" Brass Round Manifold with (5) x 1/4" Brass Industrial Couplers x (1) 3/8" Industrial Steel Plug

RECTANGULAR STYLE MANIFOLD KIT



FPM44S-KH4
4 Way Aluminum 1/4" Rectangle Pencil Manifold with (4) 1/4" Steel Industrial Coupler x (1) 1/4" Industrial Steel Plug



FPM44S-KH4B
4 Way Aluminum 1/4" Rectangle Pencil Manifold with (4) 1/4" Brass Industrial Coupler x (1) 1/4" Industrial Brass Plug

MANIFOLD

RECTANGULAR STYLE MANIFOLD KIT



FPM44S-KG4
4 Way Aluminum 1/4" Rectangle Pencil Manifold with (4) 1/4" Steel Universal Coupler x (1) 1/4" Industrial Steel Plug



FPM44SR-KH4
4 Way Aluminum Rectangle Manifold with (4) 3/8" Steel Industrial Couplers x (1) 1/4" Industrial Steel Plug



FPM44SR-KH4B
4 Way Aluminum Rectangle Manifold with (4) 1/4" Brass Industrial Couplers x (1) 1/4" Industrial Steel Plug







DOUBLE SWIVEL MANIFOLD KIT



FS244-KH4
Double Swivel Fitting 1/4" Male NPT with (2) 1/4" Steel Industrial Couplers & (1) 1/4" Steel Industrial Plug

COME IN "RETAIL-READY" BLISTER PACKS!"



	Part #	Description	Nailer / Stapler Model #
	H838	Ballistic Polyester Nail Gun Bag	Any Framer
	H850	Heavy-Duty Nail Gun Tool Bag	Any Framer
	77Bag	Heavy-Duty Skil Saw Bag	
	RP1082	Tool Repair Tags (perforated & numbered) 50/pk	
	TT33	1/2" x 33 ft PTFE Thread Sealing Tape	
	AGTG-CAP-BLACK	Promotional Caps - Black	
	AGTG-CAP-WHITE	Promotional Caps - White	

AIR TOOL OIL (ISO 22)

Model No.	Description
YL12-004	4 oz Flip top cap bottle Air Tool Oil (ISO 22)
YL12-008	8 oz Flip top cap bottle Air Tool Oil (ISO 22)
YL12-016	16 oz Flip top cap bottle Air Tool Oil (ISO 22)
YL12-128	128 oz (1 gallon) Plastic Gallon Jar Air Tool Oil (ISO 22)

Model No.	Description
YL12-004-12CS	4 oz Flip top cap bottle 12/Case (ISO 22)
YL12-008-12CS	8 oz Flip top cap bottle 12/Case (ISO 22)
YL12-016-12CS	16 oz Flip top cap bottle 12/Case (ISO 22)
YL12-128-4CS	128 oz (1 gallon) Plastic Gallon Jar 4/Case (ISO 22)



WINTER GRADE AIR TOOL OIL

Model No.	Description
YL14LT-004	4 oz Flip top cap bottle Air Tool Oil
YL14LT-008	8 oz Flip top cap bottle Air Tool Oil
YL14LT-016	16 oz Flip top cap bottle Air Tool Oil
YL14LT-128	128 oz (1 gallon) Plastic Gallon Jar Air Tool Oil

Model No.	Description
YL14LT-004-12CS	4 oz Flip top cap bottle 12/Case
YL14LT-008-12CS	8 oz Flip top cap bottle 12/Case
YL14LT-016-12CS	16 oz Flip top cap bottle 12/Case
YL14LT-128-4CS	128 oz (1 gallon) Plastic Gallon Jar 4/Case



AIR TOOL & COMPRESSOR OIL

COMPRESSOR OIL (NON-DETERGENT) (ISO 68)

Model No.	Description
YL10-016	16 oz Flat top plastic bottle Non-Detergent Compressor Oil (ISO 68)
YL10-032	32 oz / 1 Quart plastic bottle Non-Detergent Compressor Oil (ISO 68)
YL10-128	128 oz / (1 gallon) Plastic Gallon Jar Non-Detergent Compressor Oil (ISO 68)

Model No.	Description
YL10-016-12CS	16 oz Flat top plastic bottle Non-Detergent Compressor Oil 12/Case (ISO 68)
YL10-032-12CS	32 oz / 1 Quart plastic bottle Non-Detergent Compressor Oil 12/Case (ISO 68)
YL10-128-4CS	128 oz / (1 gallon) plastic gallon jar Non-Detergent Compressor Oil 4/Case (ISO 68)



COMPRESSOR OIL - 30WT (NON-DETERGENT) (ISO 100-S)

Model No.	Description
YL30-016	16 oz - Non Detergent Compressor Oil 30 Wt
YL30-032	32 oz - Non Detergent Compressor Oil 30 Wt
YL30-016-12CS	16 oz - Non Detergent Compressor Oil 30 Wt - 12/Case
YL30-032-12CS	32 oz - Non Detergent Compressor Oil 30 Wt - 12/Case



PRIVATE LABEL OPTIONS FOR AIR TOOL & COMPRESSOR OIL



PRIVATE LABEL AVAILABLE MULTIPLE SIZE BOTTLES 4OZ/8OZ/16OZ/ 32OZ/128OZ

Please Contact: sales@americangeneraltools.com

AIR TOOL & COMPRESSOR OIL

12" x 14" Shop Towels (RED)



PT722	3/pk
PT723	6/pk
PT725	12/pk
PT725-Carton	24/pk

Features:

- Easily absorbs liquids, oil, & grease
- Ideal for changing oil, refilling fluids & general automotive maintenance
- Great for cleaning most surfaces
- Strong, durable & great absorbent
- Washable & reusable

14" x 17" Terry Bar Mop Towel (white)



PT727	3/pk
PT728	6/pk
PT726	12/pk
PT729	25/pk

Features:

- 100% Super absorbent cotton ribbed terry towel
- Ideal for cleaning glasses, dishes, kitchen related utensils
- Widely used in countertops, hotels, bars, homes, restaurants and offices etc.
- Machine washable, tumble dry
- Extra absorbent, great strength, durable & soft

1 LB. Bag of Rags



PT710

Features:

- Multi-Purpose, absorbent & soft for small projects
- Excellent for staining, painting or general cleaning
- Perfect for auto, home, marine & shop use
- Soft & durable texture that won't scratch delicate surfaces
- Machine washable - Reusable - 100% New Material
- Multi-color assorted pack

SP SUPERIOR PARTS PROFESSIONAL GRADE

Superior Parts is a manufacturer and distributor of aftermarket parts, service kits, and accessories for pneumatic nailers, staplers, compressors, electric tools, machinery, and equipment. Our vision is to enable the pro contractor to get back to work as quickly as possible on their own terms.

Aftermarket parts & accessories for:

METABO / HITACHI



BOSCH



American
General Tool Group
Vista, CA



DRILL CHUCKS

ELECTRICAL CORDS

BEARINGS

SWITCHES

www.superiorparts.us



RAFTER SPRING HOOKS

SPRINGS